



ASAMAR
SURGICAL

RETRACTOR SPECIALIST

SURGICAL
Instruments
GENERAL CATALOGUE



www.retractorspecialist.com

PREFACE:

With gratitude to Almighty Allah for His blessings and guidance, we proudly present the **General Surgical Instruments** Catalog by Asamar Surgical Retractor Specialist. This catalog reflects our continued dedication to quality, precision, and the advancement of surgical excellence. For over four decades, our family has remained deeply committed to the art of surgical instrument manufacturing. What began in Sialkot as a humble craft has evolved into a trusted name recognized for reliability, consistency, and attention to every technical detail. Through continuous improvement, modern production methods, and skilled craftsmanship, we aim to meet the highest expectations of healthcare professionals worldwide. This edition has been carefully curated to serve as a complete reference for a wide range of general surgical instruments. Each instrument represents our promise of quality, durability, and user comfort.

While every effort has been made to ensure accuracy, we always welcome feedback and new ideas that contribute to better outcomes for surgeons and patients alike. Beyond general surgery, **Asamar Surgical** also offers specialized product ranges across multiple disciplines including ENT, Orthopedic, Dental, and Ophthalmic instruments, all developed with the same commitment to excellence that defines our brand.

We extend our sincere thanks to our valued partners and clients whose trust continues to inspire our growth. It is our hope that this catalog becomes a reliable companion in your work, a reflection of our shared mission to enhance surgical precision and patient care across the globe. **Asamar Surgical Retractor Specialist** holds globally recognized certifications that reflect our compliance with international quality and safety standards, including: **ISO 9001, ISO 13485 and CE Certification**.

These certifications ensure that our clients are always in the most trusted hands when it comes to quality and consistency. Our Quality Policy guarantees that every instrument is manufactured to its highest standard, undergoing strict quality inspections at every stage of production. We believe that long-term relationships are built on trust, reliability, and performance, values that drive us to continuously enhance our processes and exceed customer expectations. Our mission remains clear: to deliver superior instruments that support surgeons and healthcare professionals in achieving better patient outcomes, every single day.

Production View

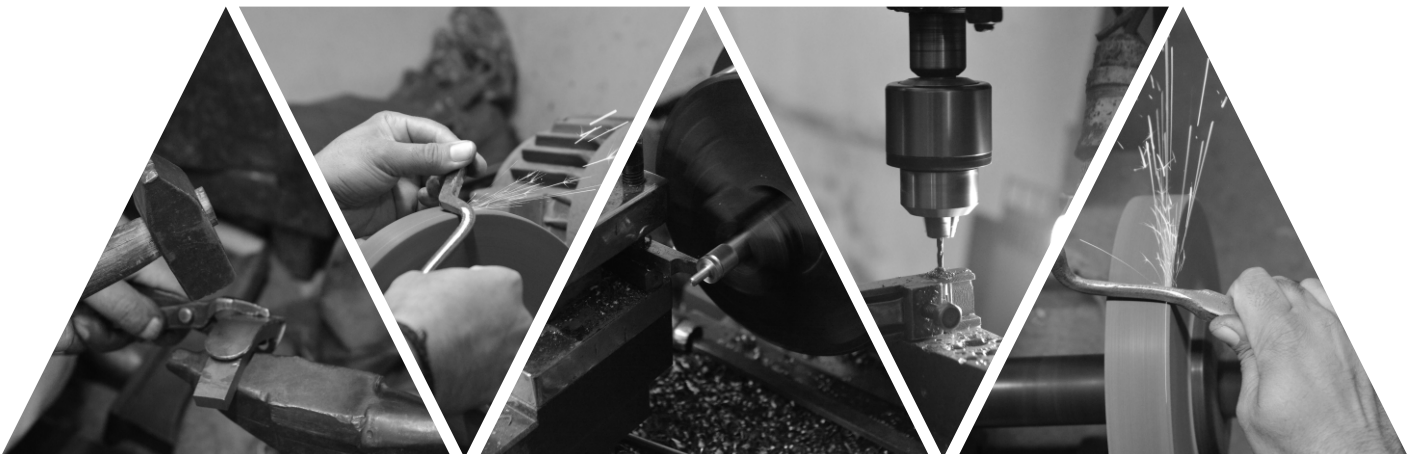



TABLE OF CONTENTS









01		Percussion Hammers & Aesthesiometers Tongue Depressors Diagnostic Sets Examination & Measuring Instruments Dissecting Knives Scalpels, Tenotomes & Resection Knives	PAGE 01-21
02		Scissors	PAGE 22-70
03		Probes Cotton Applicators Suture Clips Clip Applying Forceps And Removing Forceps	PAGE 71-77
04		Self-Retaining Retractors Abdominal Retractors	PAGE 78-102
05		Sponge and Dressing Forceps Washing Forceps Organ and Tissue Grasping Forceps Towel Clamps	PAGE 103-111
06		Bone Punches Rongeurs Amputation	PAGE 112-130
07		Dissecting and Tissue Forceps	PAGE 131-147
08		Obstetrics Tracheotomy	PAGE 148-156



TABLE OF CONTENTS



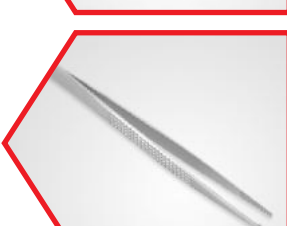





09		Haemostatic Forceps	PAGE 157-185
10		Ent Surgery	PAGE 186-222
11		Elevators Bone Levers Raspatories Bone Files Bone Curettes	PAGE 223-241
12		Trocars	PAGE 242
13		Vaginal Specula	PAGE 243-253
14		Wound Retractors	PAGE 254-288
15		Dilators Bioopsy Instruments And Curettes Uterine Probes, Uterine Dressing - Tenaculum Ovum Forceps Uterine Elevating Forceps	PAGE 289-311
16		Cardiovascular And Thoracic Surgery Muller Vessel Clips Bulldog Clamps	PAGE 312-374

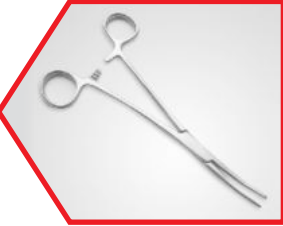

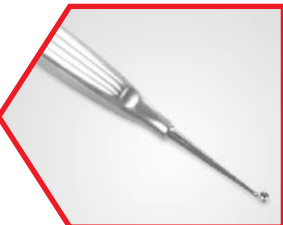
TABLE OF CONTENTS

17



**Needle Holders
Suture Instruments
Ligature Needles
Guiding Probes**

PAGE 375-395

18

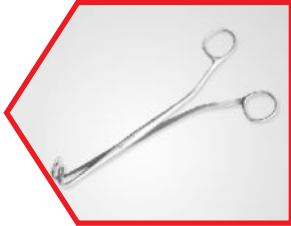

**Gall Bladder, Liver and Spleen
Instruments
Genito Urinary
Instruments**

PAGE 396-406

19



**Mallets
Tempers, Chisels, Gouges
Bone Holding Forceps
Rongeurs
Bone Cutting Forceps
Meniscus Instruments**

PAGE 407-463

20



Plaster Instruments

PAGE 464-470

21

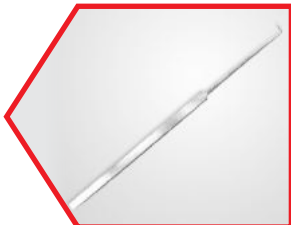

**NeuroSurgery
Laminectomy**

PAGE 471-499

22

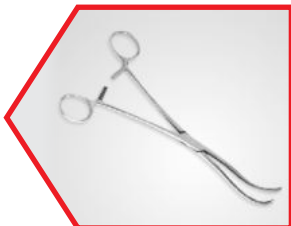

**Abdominal Surgery
Intestinal and Rectal Instruments**

PAGE 500-534

23



Micro Instruments

PAGE 535-551

24



Suction Instruments

PAGE 552-564



ASAMAR
SURGICAL 

PAGE

01-21

**PERCUSSION HAMMERS
& AESTHESIOMETERS
TONGUE DEPRESSORS
DIAGNOSTIC SETS, EXAMINATION
& MEASURING INSTRUMENTS
DISSECTING KNIVES SCALPELS,
TENOTOMES & RESECTION KNIVES**



AS-01-101
TROEMNER
245 mm

1/2



AS-01-102
DEJERINE
200 mm

1/2



AS-01-103
DEJERINE
With Needle
210 mm

1/2



AS-01-104
TAYLOR
195 mm

1/2



AS-01-105
BERLINER
200 mm

1/2

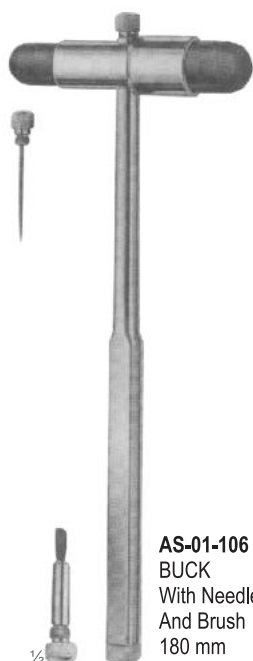

AS-01-106
BUCK
With Needle
And Brush
180 mm

1/2

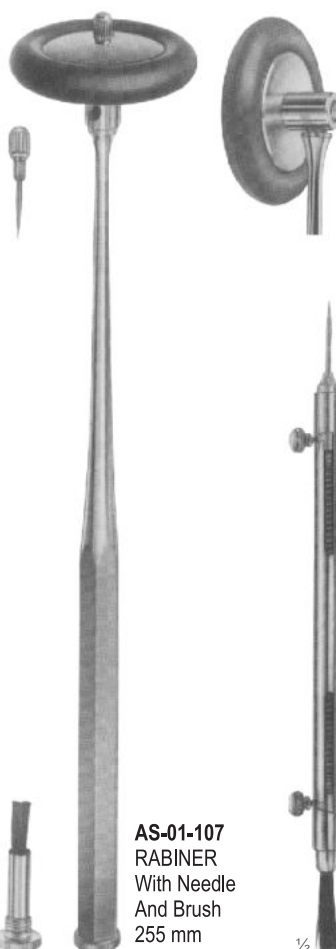

AS-01-107
RABINER
With Needle
And Brush
255 mm

1/2



AS-01-108
ALY
190 mm

1/2



AS-01-109
WARTENBERG
Pinwheel For
Neurological
Examination
185 mm

1/2

TONGUE DEPRESSORS



ASAMAR
SURGICAL

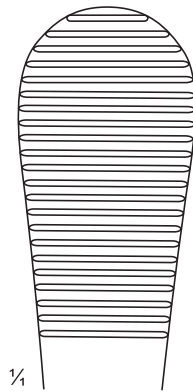

1/4
72 X 24 mm

1/2
AS-01-110
HARTMANN
150 mm

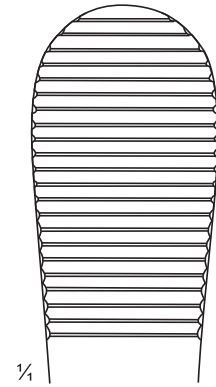

1/4
83 X 25 mm

1/2
AS-01-111
TOBOLD
150 mm

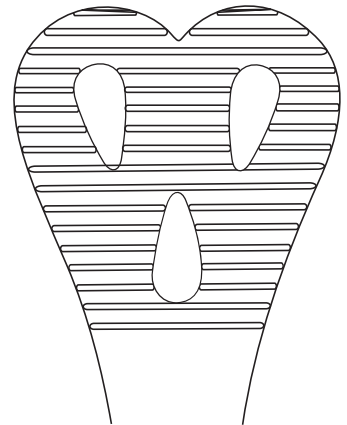

AS-01-113
15 cm
43 mm

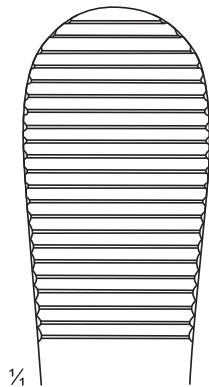
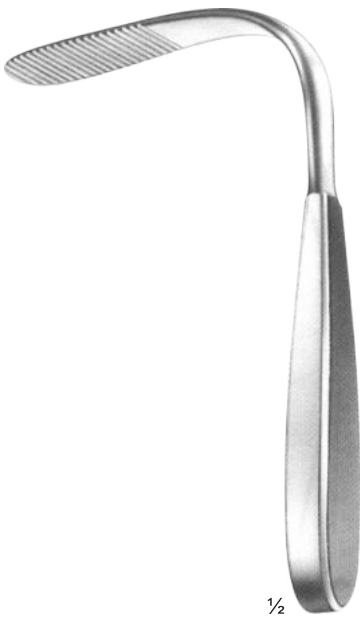

1/2
AS-01-112
TOBOLD
160 mm



1/2
AS-01-113 - AS-01-114
WIEDER

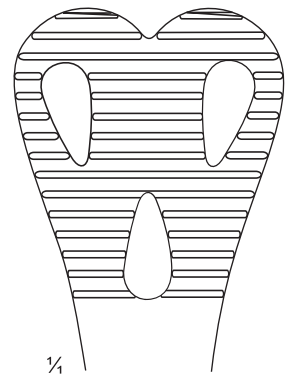

1/4
AS-01-114
140 mm
36 mm

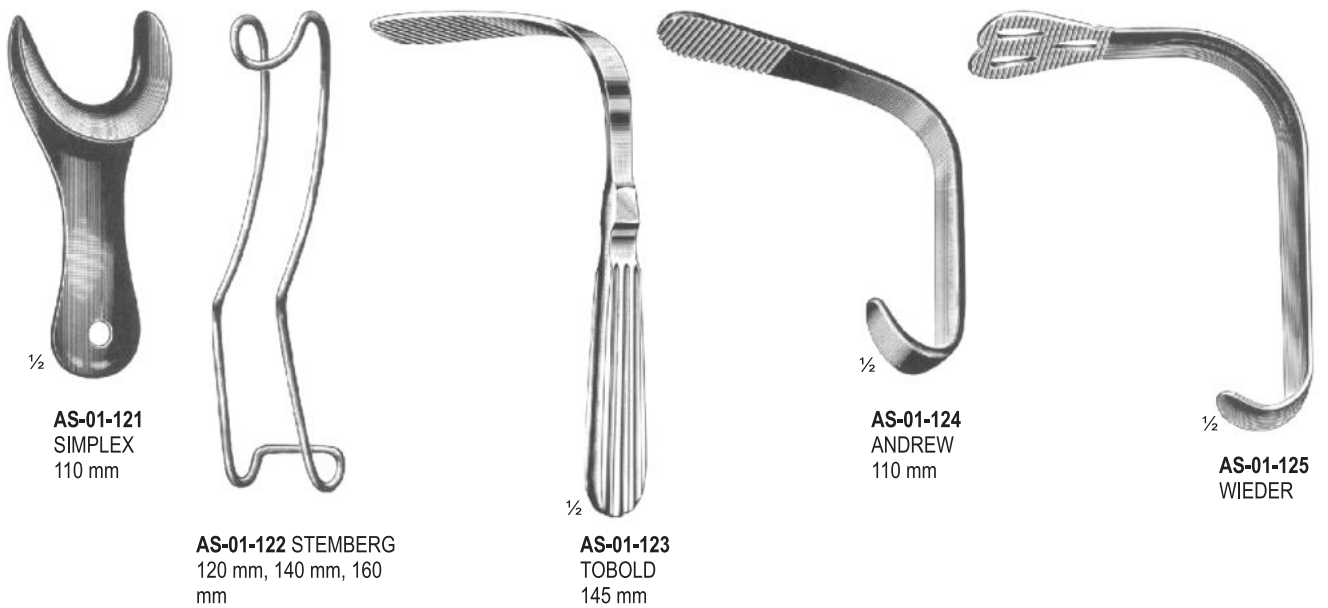
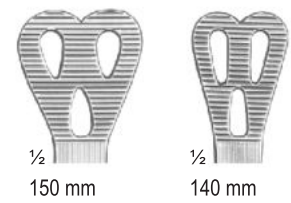
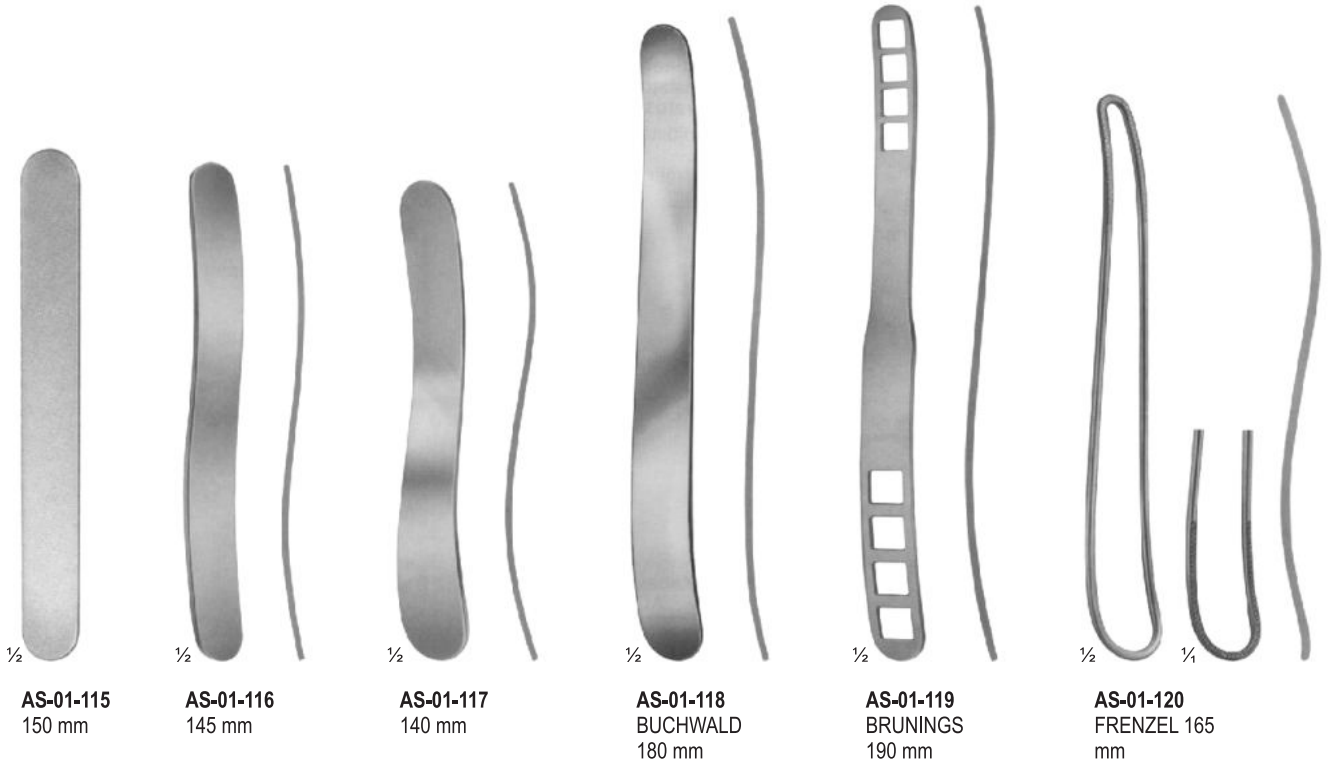



1/2

AS-01-126
HEISTER
Mouth Gag
Size: 130
mm



1/2

AS-01-127
FERGUSON-ACKLAND
Mouth Gag
Size: 145 mm



1/2

AS-01-128 DENHARDT
Mouth Gag With Silicon
Inserts,
InterchangeSfle Size:
125 mm



1/2

AS-01-129
ROSER KONIG
Mouth Gag
Size: 160 mm,
185 mm

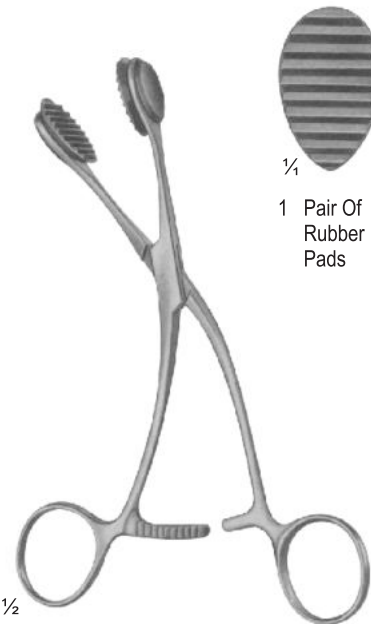

1/2

AS-01-130
YOUNG 165
mm



1/4

1 Pair Of
Rubber
Pads

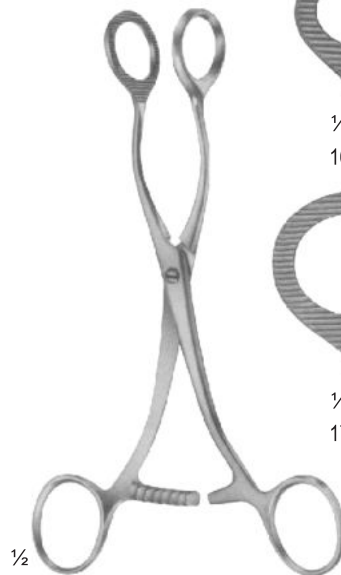

1/2

AS-01-131
COLLIN
160 mm, 170
mm



1/4

160 mm



1/4

170 mm

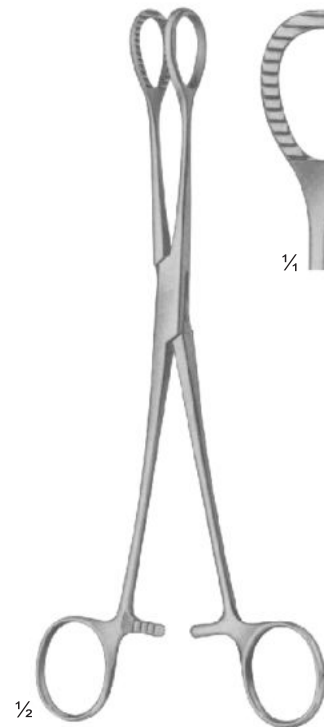

1/2

AS-01-132 HEYWOOD-
SMITH modif.
215 mm



1/4

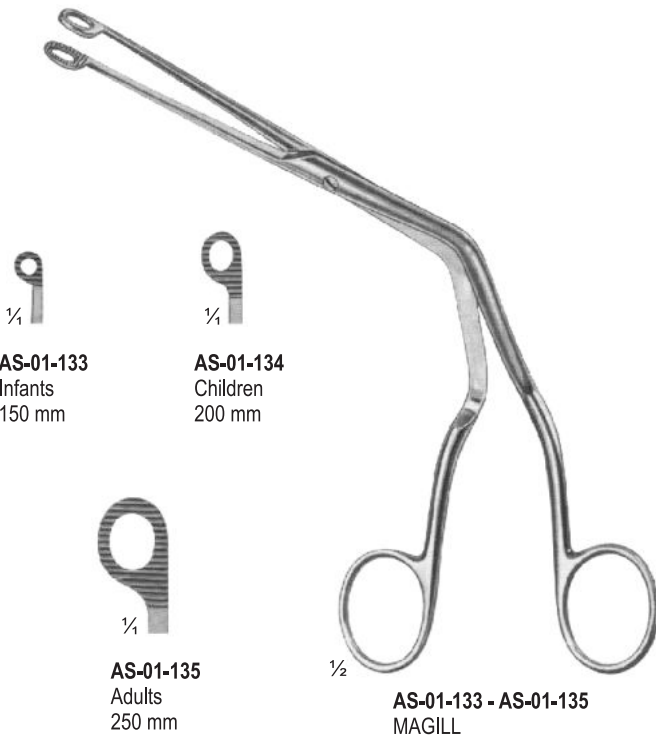

AS-01-133
Infants
150 mm

AS-01-134
Children
200 mm

AS-01-135
Adults
250 mm

AS-01-133 - AS-01-135
MAGILL



AS-01-136
TUBING CLAMP
7", 8"
180 mm, 200
mm



AS-01-137
Medium battery
handle only, 25 mm
diam.



AS-01-138
Spare bulb
2.7 volt, for
otoscopes



AS-01-139
Spare bulb
2.6 volt, for
ophthalmoscopes



AS-01-140
Otoscope Set, Consists Of
Battery Handle Without Batteries,
3 Ear Specula, 1 Bulb In Velvet Lined
Case



AS-01-141
Diagnostic Set, Otoscope With Three Specula,
Nasal Speculam, Lamp Holder, Two Laryngeal
Mirrors, Tongue Blade Holder



1/3

AS-01-142 MILLER
Laryngoscope Set, Consists Of Battery Handle
(Without Battery) With Four Miller
Laryngoscope Blades

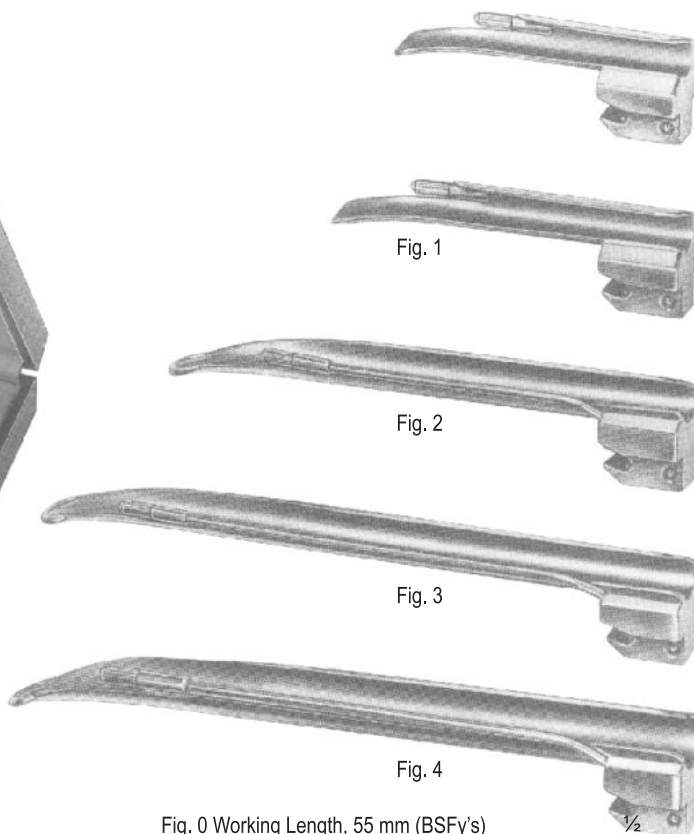

Fig. 0 Working Length, 55 mm (BSFy's)
Fig. 1 Working Length, 80 mm (Children's)
Fig. 2 Working Length, 130 mm (Adolescent's)
Fig. 3 Working Length, 170 mm (Women's)
Fig. 4 Working Length, 180 mm (Men's)



1/3

AS-01-143 GUEDEL-NEGUS
Laryngoscope Set, Consists Of Battery Handle
(Without Battery) With Four Miller
Laryngoscope Blades

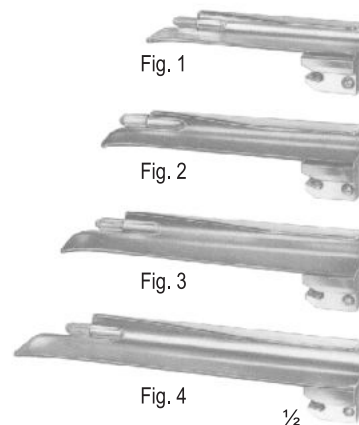

Fig. 1 Working Length, 70 mm (Children's)
Fig. 2 Working Length, 90 mm (Adolescent's)
Fig. 3 Working Length, 110 mm (Women's)
Fig. 4 Working Length, 135 mm (Men's)



AS-01-144 McIntosh
Laryngoscope Set, Consists Of Battery Handle
(Without Battery) With Three McIntosh Blades,
Fig. 1, Fig. 2, Fig. 3



Fig. 0

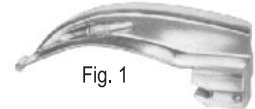

Fig. 1



Fig. 2



Fig. 3

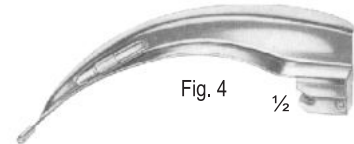

Fig. 4

AS-01-145 McIntosh
Laryngoscope Set, Consists Of Battery Handle (Without Battery)
With Five McIntosh Blades, Fig. 1, Fig. 2, Fig. 3, Fig. 4, Fig. 5

- Fig. 0 Working Length, 55 mm (BSFy's)
- Fig. 1 Working Length, 75 mm (Children's)
- Fig. 2 Working Length, 90 mm (Adolescent's)
- Fig. 3 Working Length, 110 mm (Women's)
- Fig. 4 Working Length, 135 mm (Men's)



AS-01-146 6GER
Laryngoscope Set, Consists Of
Battery Handle (Without Battery)
With Three Foregger Blades,
Fig. 1, Fig. 2, Fig. 3,



Fig. 1



Fig. 2



Fig. 3



Fig. 4

AS-01-147 FOREGGER
Laryngoscope Set, Consists Of
Battery Handle (Without Battery)
With Five Foregger Blades,
Fig. 1, Fig. 2, Fig. 3, Fig. 4, Fig. 5

- Fig. 1 Working Length, 70 mm (Children's)
- Fig. 2 Working Length, 90 mm (Adolescent's)
- Fig. 3 Working Length, 110 mm (Women's)
- Fig. 4 Working Length, 135 mm (Men's)



AS-01-148
Fiber Optic
Battery
Handle



AS-01-149
Fiber Optic
Battery
Handle



AS-01-150
Replacement Lamp
(Krypton) 2.5 V



AS-01-151
Replacement
Lamp (Halogen)
2.5 V



AS-01-152
Boley



Metal: **AS-01-153**
Wax : **AS-01-154**
Double Side
Marking Iwanson



AS-01-155
CAROLL
140 mm



AS-01-156
TOWNLEY
100 mm



AS-01-157 BERTILLON
Caliper For Measuring The Head
320 mm



AS-01-158
CASTROVIEJO
Caliper



AS-01-159
MOLTGEN
Goniometer



AS-01-160
Fig. 1



AS-01-161
Fig. 2



AS-01-162
Fig. 3



AS-01-163
Fig. 4



AS-01-164
Fig. 5



AS-01-165
Fig. 6



AS-01-166
Fig. 7



AS-01-167
Fig. 8



AS-01-168
Fig. 9



AS-01-169
Fig. 10

AS-01-160 - AS-01-169
Fig. 1 - 10

SCALPELS, TENOTOMES & RESECTION KNIVES



ASAMAR
SURGICAL

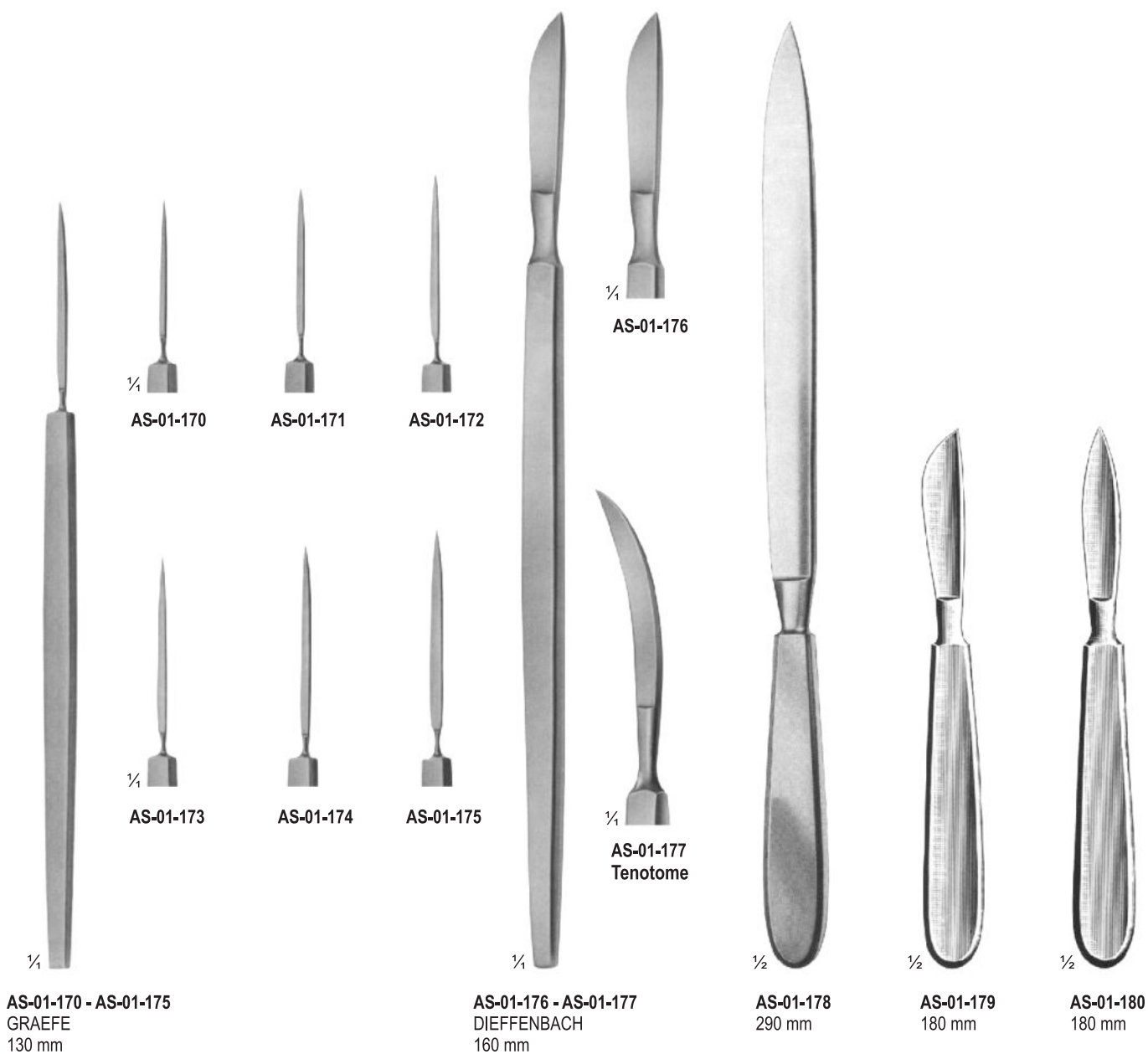



AS-01-181
130 mm
AS-01-182
160 mm
AS-01-183
190 mm
AS-01-184
200 mm

AS-01-185
CATLIN
160 mm
Blade Length
Amputating
Knives

AS-01-186
LANGENBECK
120 mm
Blade Length
Flap Knives

AS-01-187
110 mm
Blade Length
Interosseous
Knives

AS-01-188
55 mm
Blade Length
With Raspatory,
Wooden
Handle

AS-01-189
70 mm
Blade Length
Wooden
Handle

AS-01-190
80 mm
Blade Length
Metal Handle

AS-01-191
195 mm
Blade Length
Metal Handle

Blade Length
Amputating Knives



AS-01-192
AYRE
235 mm
Cone Knife

AS-01-193
230 mm
Cone Knife

AS-01-194
SEGOND
270 mm
Myomatome

AS-01-195
OLIVECRONA
205 mm
Trigeminal
Knife

AS-01-196 230
mm
Trigeminal
Knife

AS-01-197
FOWLER
200 mm
Tonsil
Knife

AS-01-198
SFRAHAM
215 mm
Tonsil
Knife

AS-01-199
BRUNING
S 215 mm
Tonsil
Knife

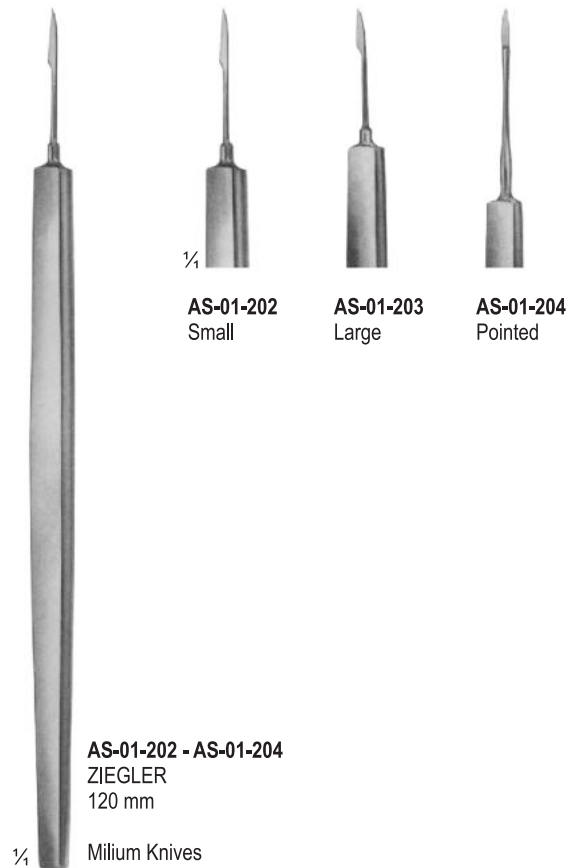
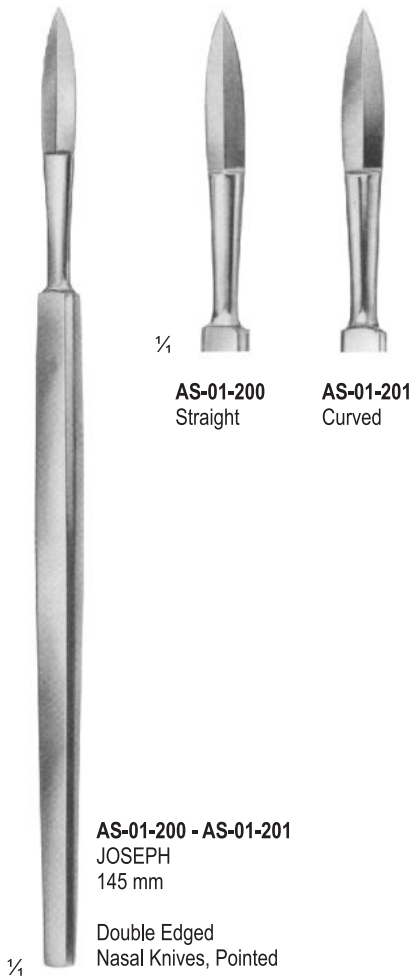



AS-01-209
STANDARD
No. 4 Solid

AS-01-210
Double Handle
No. 4 + No. 3
Solid

AS-01-211
No. 4 L
Straight
Solid

AS-01-212
No. 4 L
Solid
Angled

AS-01-213
COLLIN No.
8 Hollow

AS-01-214
COLLIN No.
9 Hollow

AS-01-215
Plastic



AS-01-216
STANDARD
No. 3 Solid



AS-01-217
No. 3 Solid



AS-01-218
No. 3 Solid



AS-01-219
No. 3 L
Straight
Solid



AS-01-220
No. 3 L
Angled
Solid



AS-01-221
No. 7 Solid



AS-01-222
No. 7 K Solid



AS-01-223
Hollow-Round



AS-01-224
No. 3 Straight
Solid



AS-01-225
25.5 cm



AS-01-226
VIRCHOW



AS-01-227 - AS-01-229
VIRCHOW

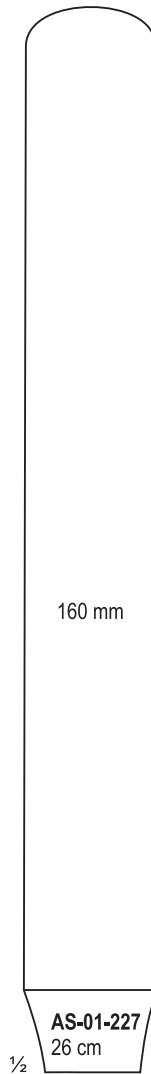

1/2

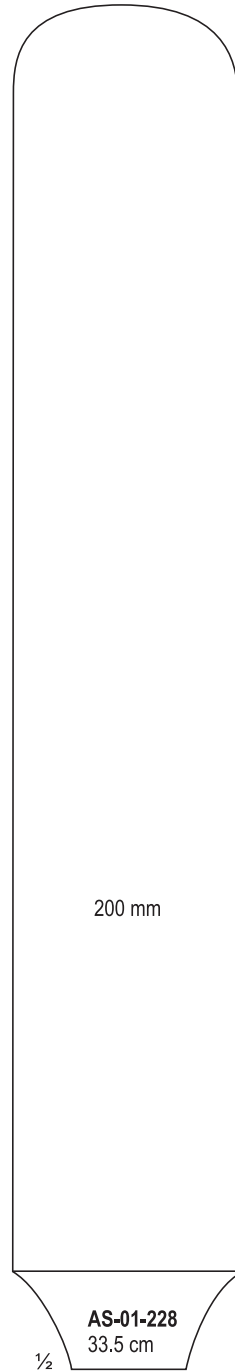

1/2

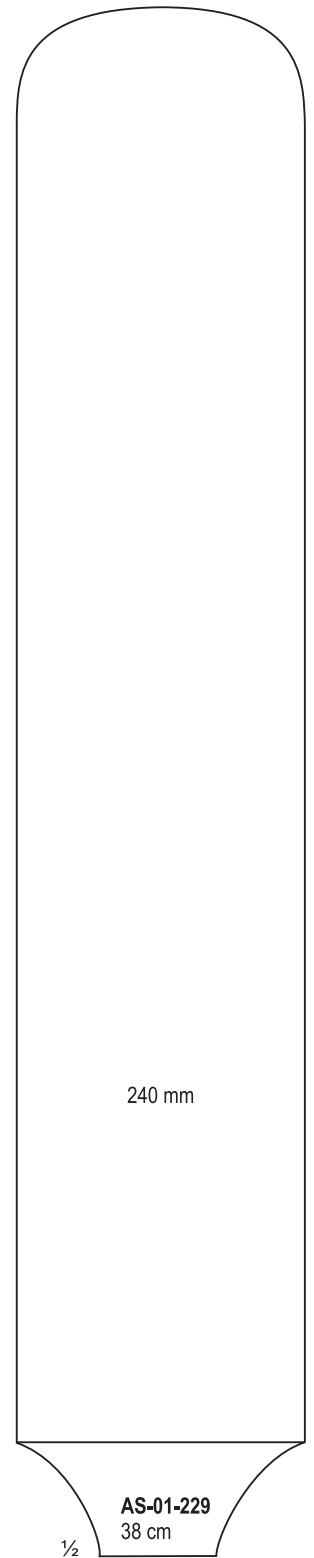

1/2



AS-01-230
TROUTMAN-CHRIS
9 cm



AS-01-231
TROUTMAN-CHRIS
9 cm



AS-01-232
11 cm



AS-01-233
CASTROVIEJO
13 cm



AS-01-234
18.5 cm



1/2

HUMBY AS-01-235 32 cm



HUMBY AS-01-235



1/2

AS-01-236
SCHINK 30 cm



SCHINK AS-01-236



1/2

AS-01-237
SILVER 19,5 cm



AS-138
PARKER



AS-139

9.5 cm

11 cm



AS-140
COBBETT



AS-141
BRAITHWATTE



Spare Blade



AS-142
HUMBY
35 cm

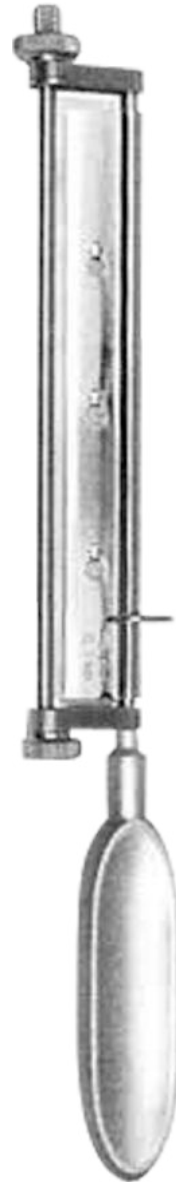

AS-143
WATSON
30 cm



ASAMAR
SURGICAL 

PAGE
22-70
SCISSORS

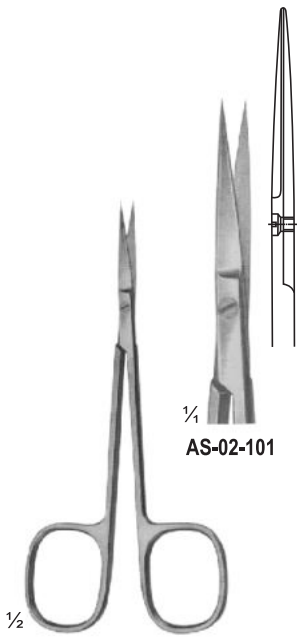

AS-02-101 - AS-02-102
120 mm

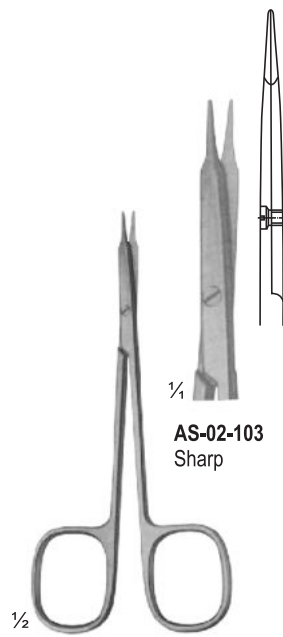
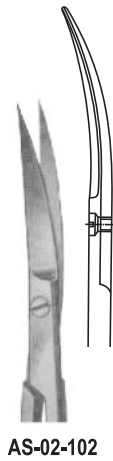

AS-02-103 - AS-02-106
STEVENS
Dissecting Scissors
115 mm

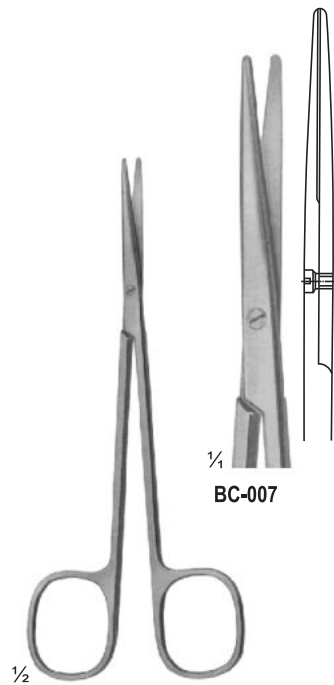

AS-02-107 - AS-02-108
METZENBAUM
Dissecting Scissors
145 mm

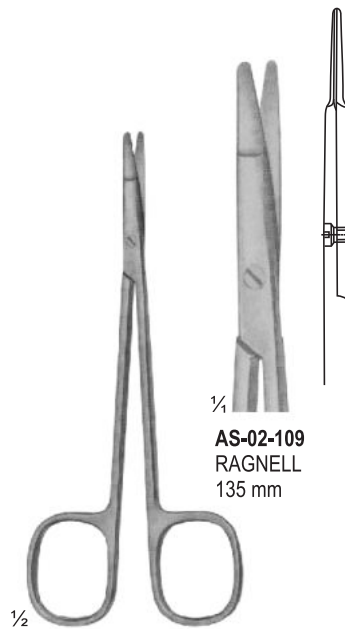
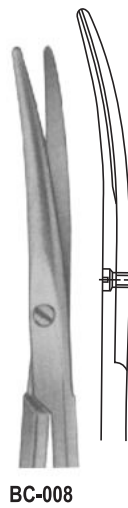

AS-02-109 - AS-02-111
Special flat points for
dissecting and
undermining the skin
145 mm

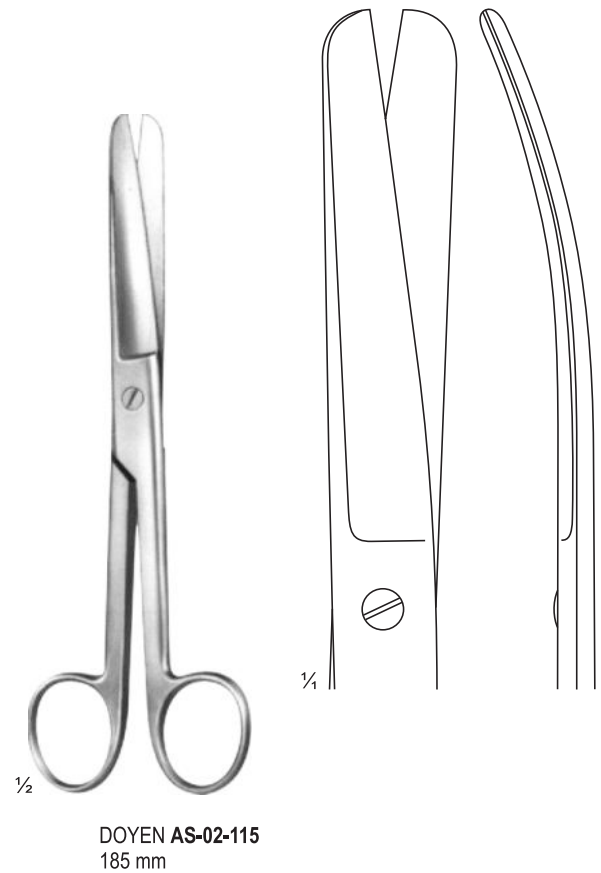
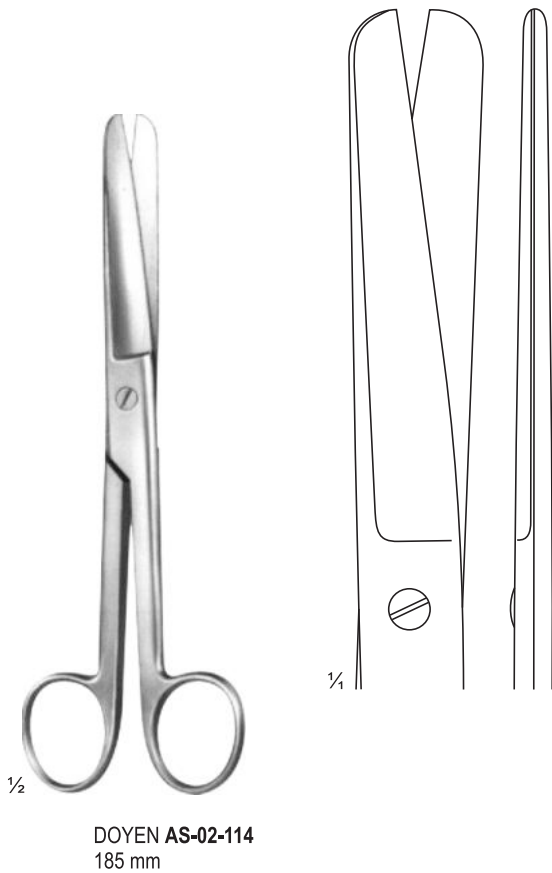
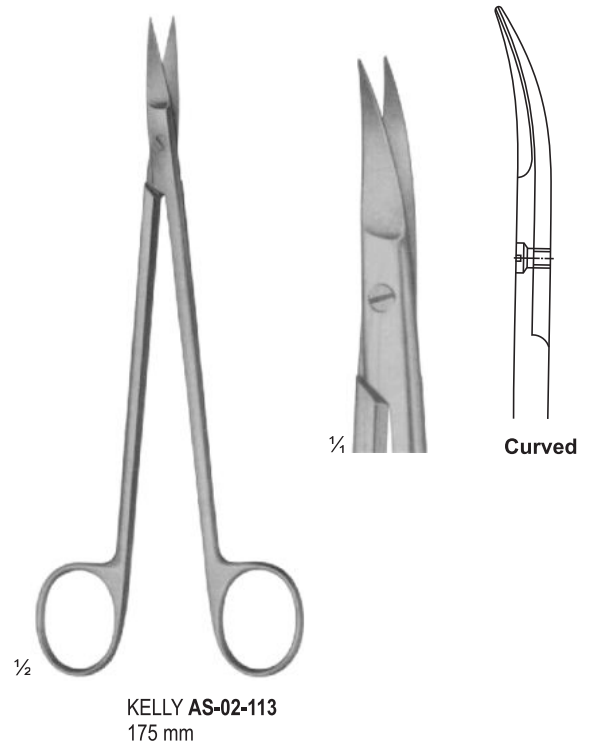
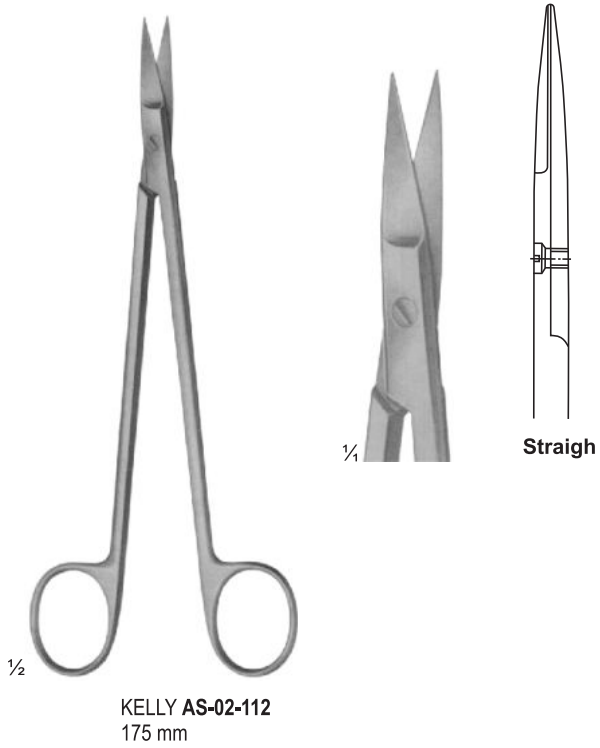

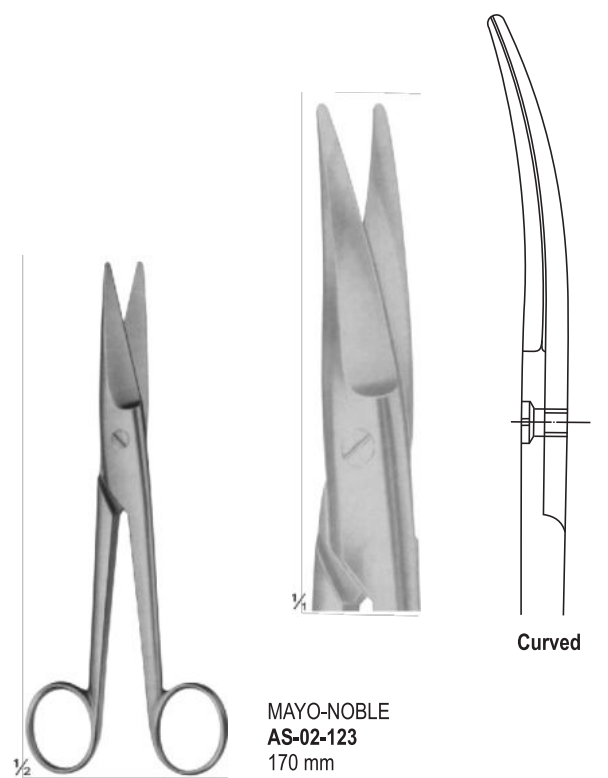
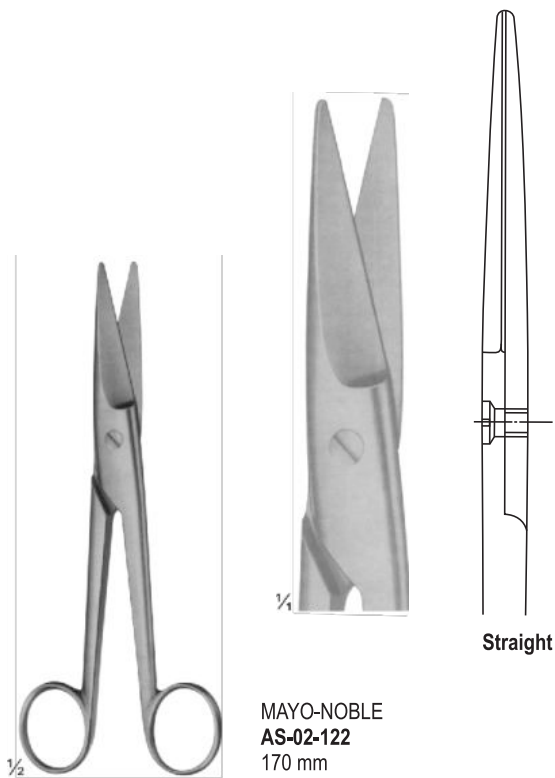
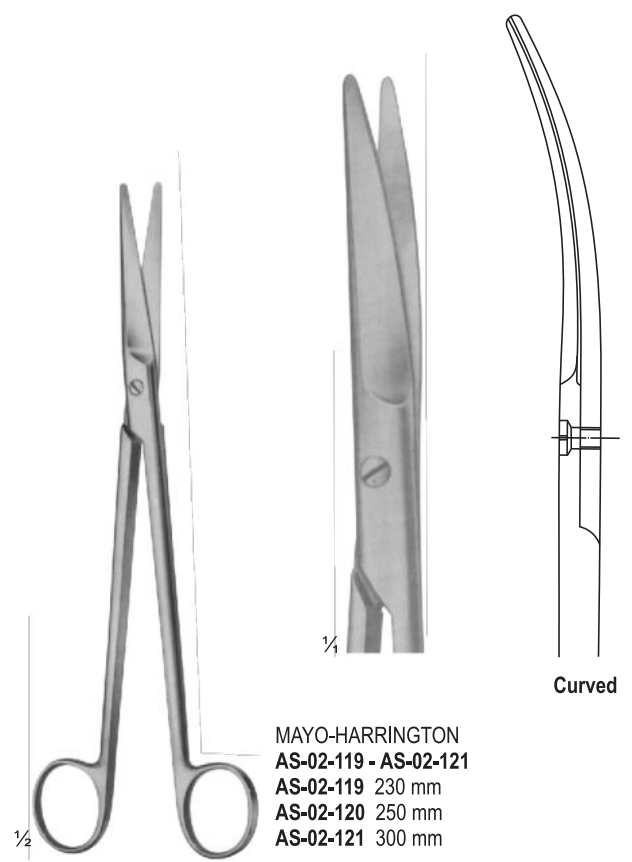
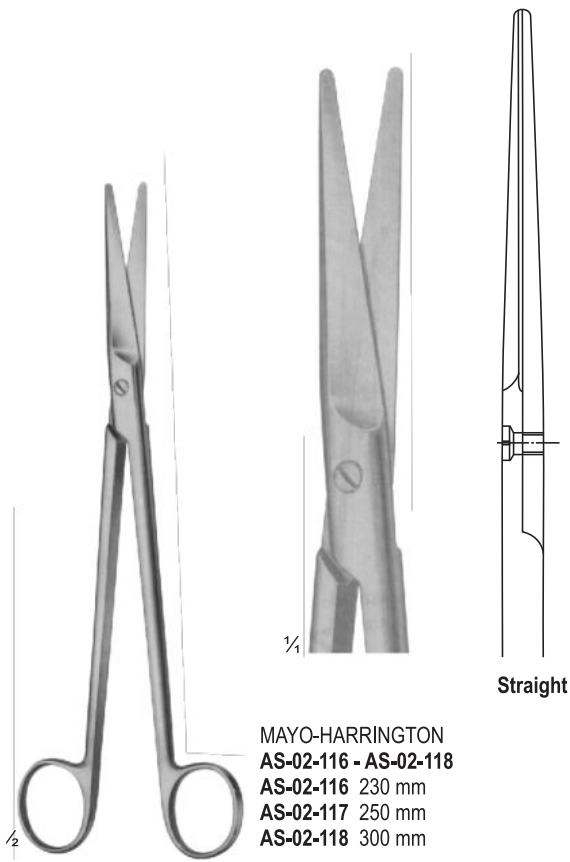

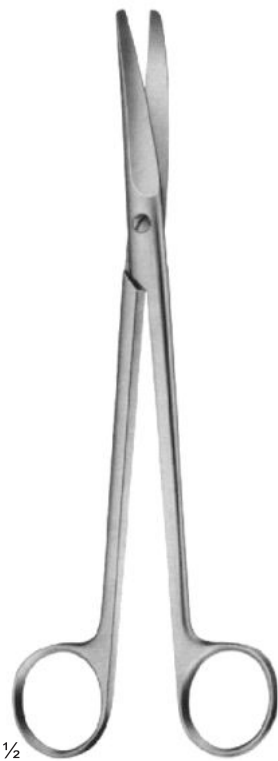

1/2

SIMS
AS-02-124 - AS-02-126
AS-02-124 200 mm
AS-02-125 210 mm
AS-02-126 230 mm



1/4



Curved



1/2

WERTHEIM
AS-02-127 - AS-02-129
AS-02-127 145 mm
AS-02-128 200 mm
AS-02-129 230 mm



1/4



Curved



1/2



Straight

- FINO-METZENBAUM
AS-02-130 - AS-02-135
AS-02-130 180 mm
AS-02-131 200 mm
AS-02-132 230 mm
AS-02-133 260 mm
AS-02-134 280 mm
AS-02-135 300 mm



1/2



Curved

- FINO-METZENBAUM
AS-02-136 - AS-02-141
AS-02-136 180 mm
AS-02-137 200 mm
AS-02-138 230 mm
AS-02-139 260 mm
AS-02-140 280 mm
AS-02-141 300 mm

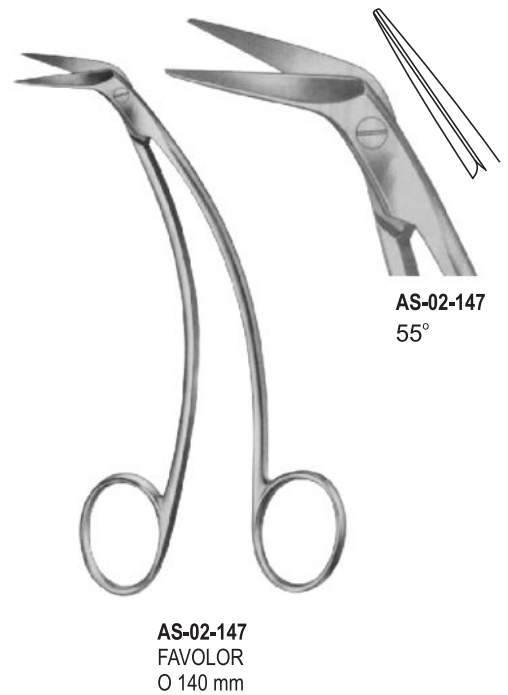
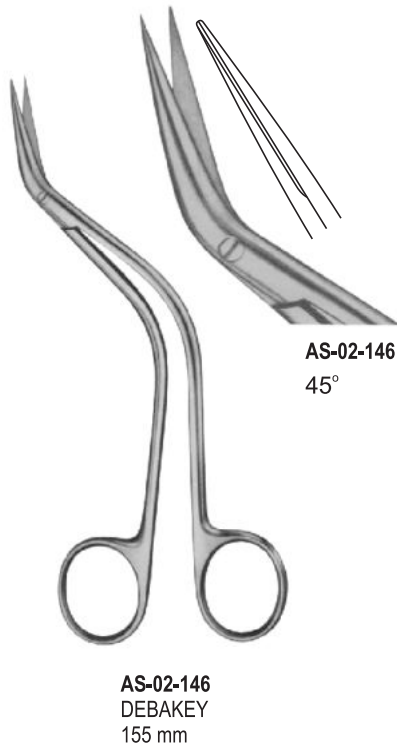
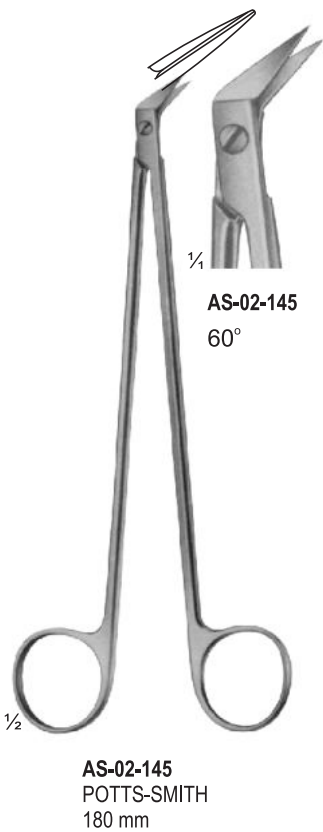
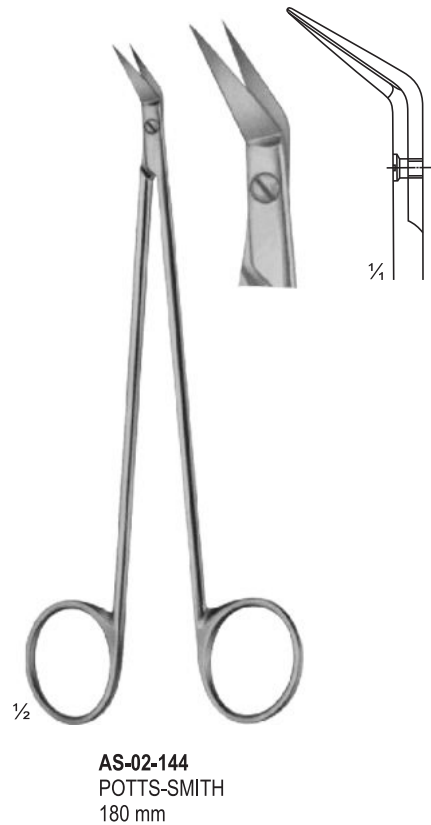
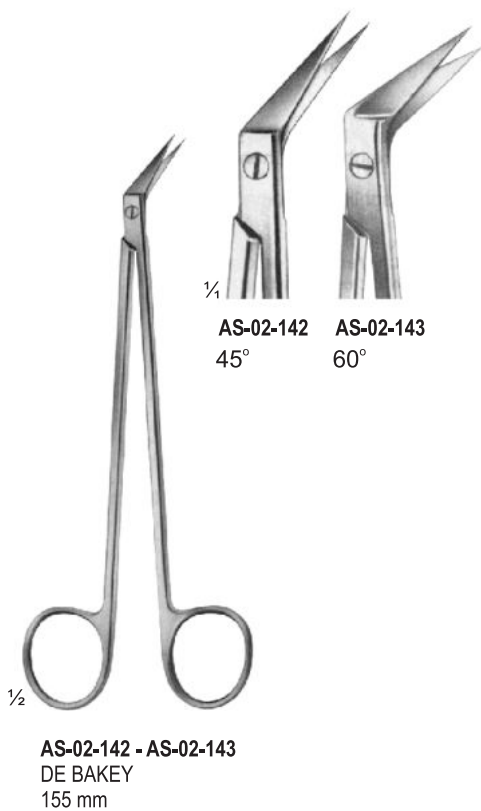

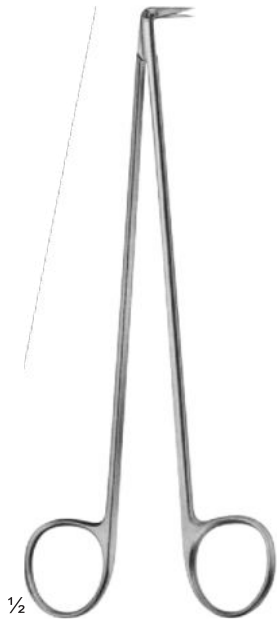

1/2

DIETHRICH
AS-02-148 - AS-02-152

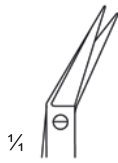

1/4

AS-02-148
190 mm
25°

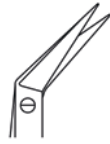

AS-02-149
185 mm
45°



AS-02-150
175 mm
60°



AS-02-151
175 mm
90°



AS-02-152
175 mm
120°



1/2

MIKRO-HEGEMANN
AS-02-153 - AS-02-157
185 mm



1/4

AS-02-153
25°

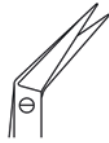

AS-02-154
45°

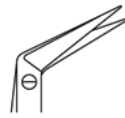

AS-02-155
60°



AS-02-156
90°



AS-02-157
120°

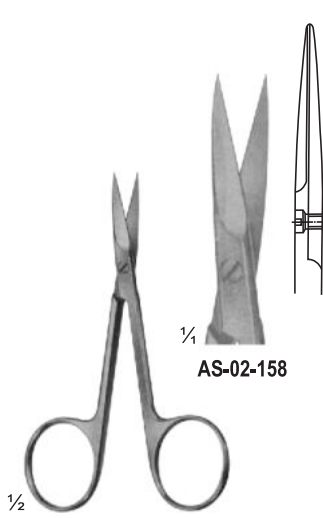

AS-02-158

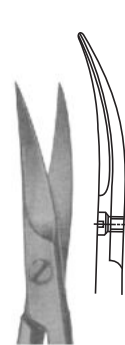

AS-02-159

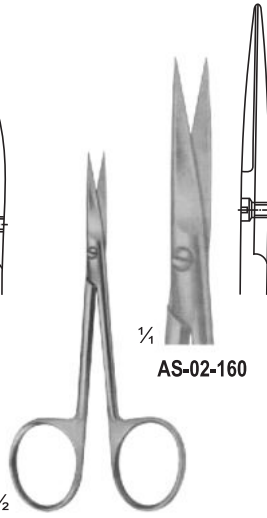

AS-02-160

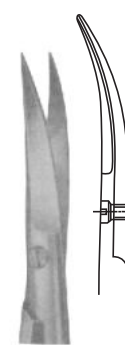

AS-02-161

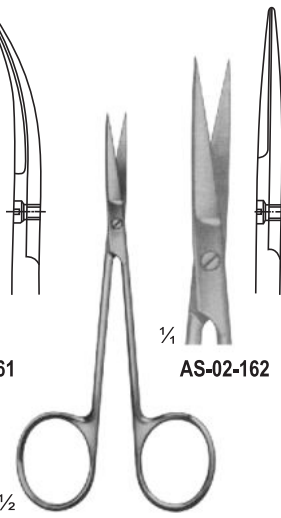

AS-02-162

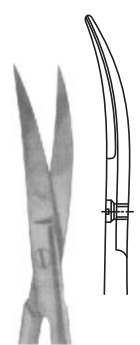

AS-02-163

AS-02-158 - AS-02-159
Cutical
90 mm

AS-02-160 - AS-02-161
95 mm

AS-02-162 - AS-02-163
Iris
100 mm

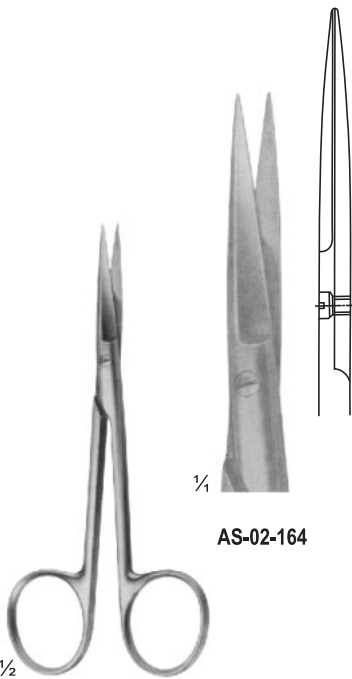

AS-02-164

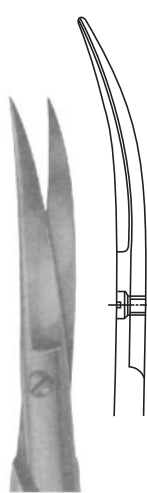

AS-02-165

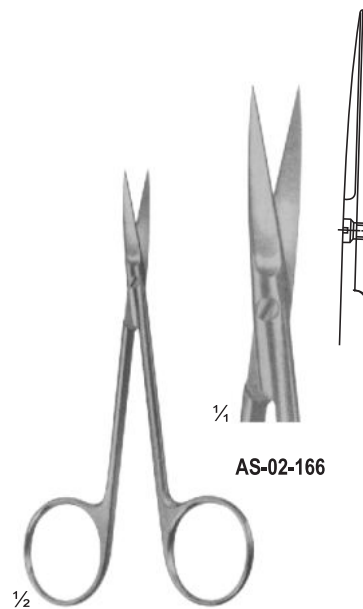

AS-02-166

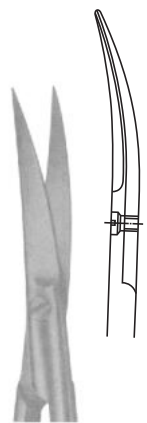

AS-02-167

AS-02-164 - AS-02-165
Wagner
130 mm

AS-02-166 - AS-02-167
Iris
110 mm



1/2

AS-02-168 - AS-02-170
Fine Operating
Scissors 120 mm

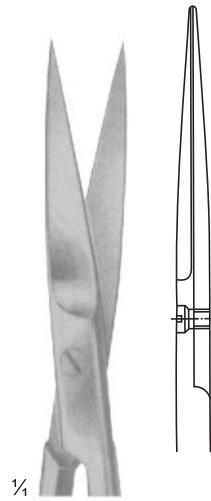

1/4

AS-02-168

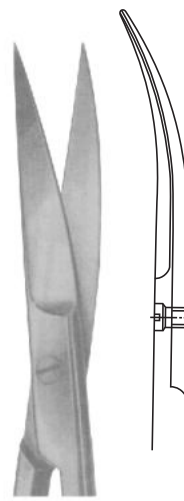

AS-02-169

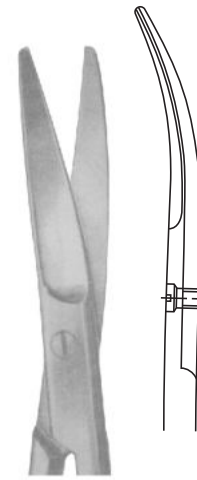

AS-02-170



1/2

AS-02-171 - AS-02-174
Fine Operating
Scissors 130 mm

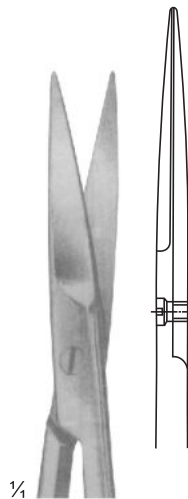

1/4

AS-02-171

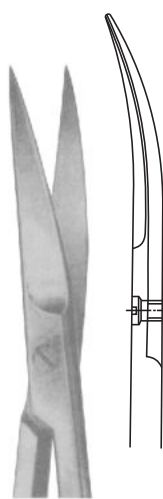

AS-02-172

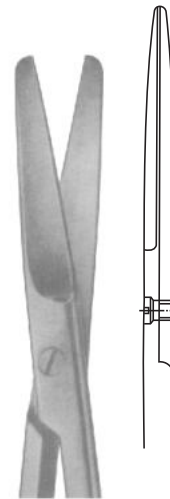

AS-02-173

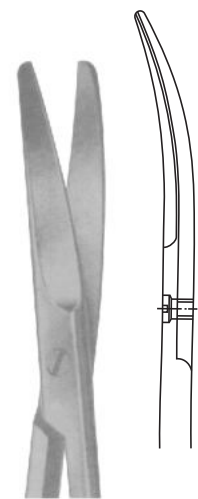

AS-02-174

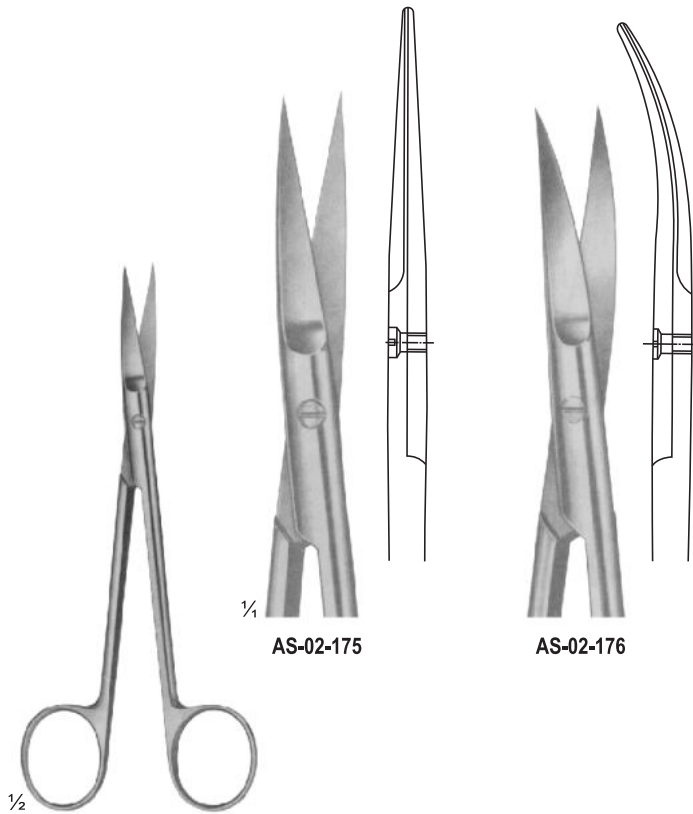

AS-02-175

AS-02-176

AS-02-175 - AS-02-176
JOSEPH
150 mm

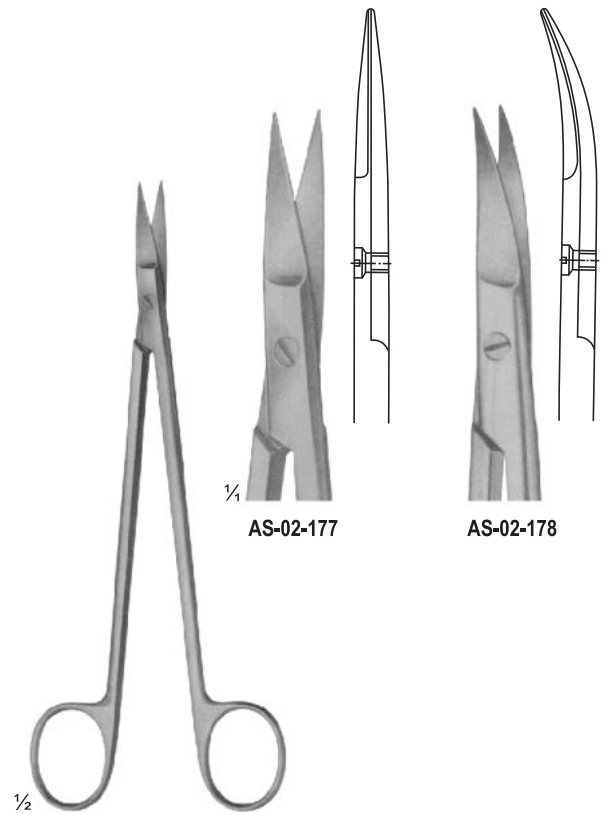

AS-02-177

AS-02-178

AS-02-177 - AS-02-178
KELLY
175 mm

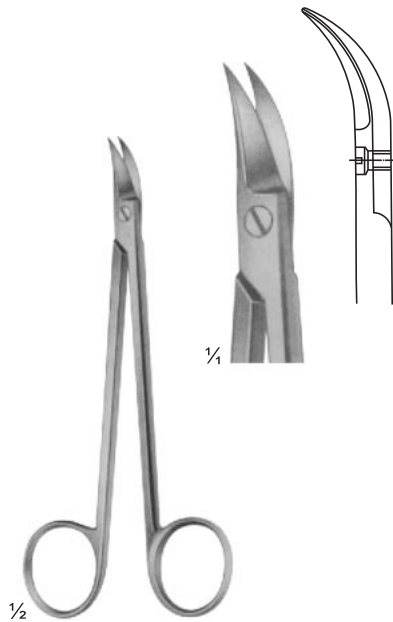

AS-02-179
QUINBY
130 mm

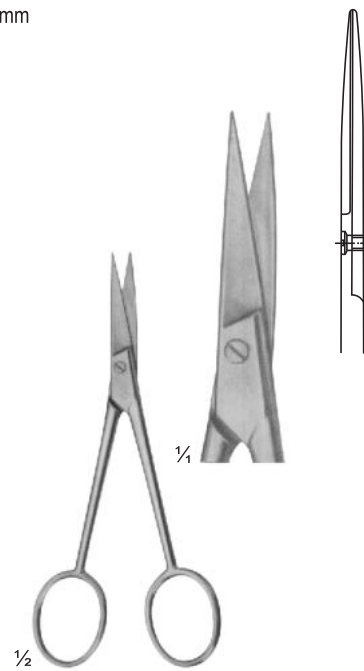

AS-02-180
Dissecting
110 mm

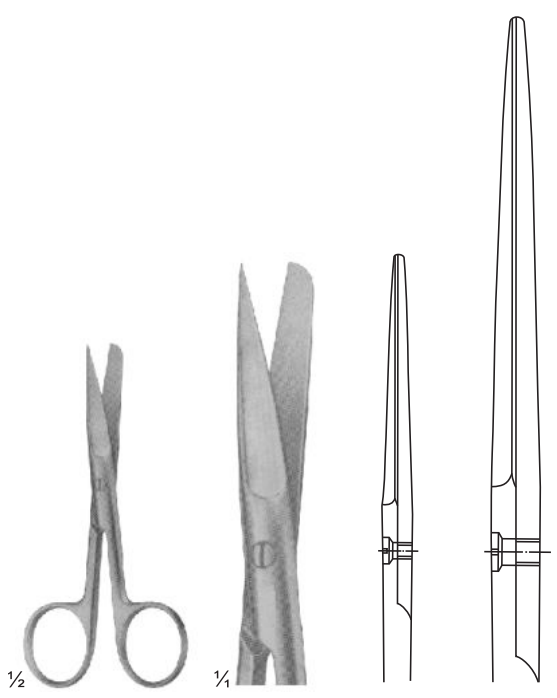

AS-02-181 - AS-02-189 (Standard Types)
AS-02-181 (105 mm)
AS-02-182 (115 mm)
AS-02-183 (130 mm)
AS-02-184 (145 mm)
AS-02-185 (150 mm)
AS-02-186 (165 mm)
AS-02-187 (175 mm)
AS-02-188 (185 mm)
AS-02-189 (200 mm)

AS-02-181 105 mm
AS-02-189 200 mm

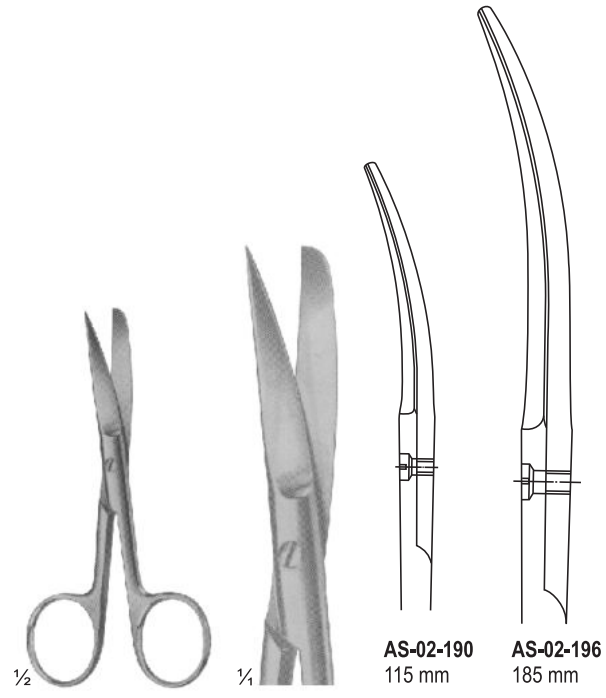

AS-02-190 - AS-02-195 (Standard Types)
AS-02-190 (115 mm)
AS-02-191 (130 mm)
AS-02-192 (145 mm)
AS-02-193 (150 mm)
AS-02-194 (165 mm)
AS-02-195 (175 mm)
AS-02-196 (185 mm)

AS-02-190 115 mm
AS-02-196 185 mm

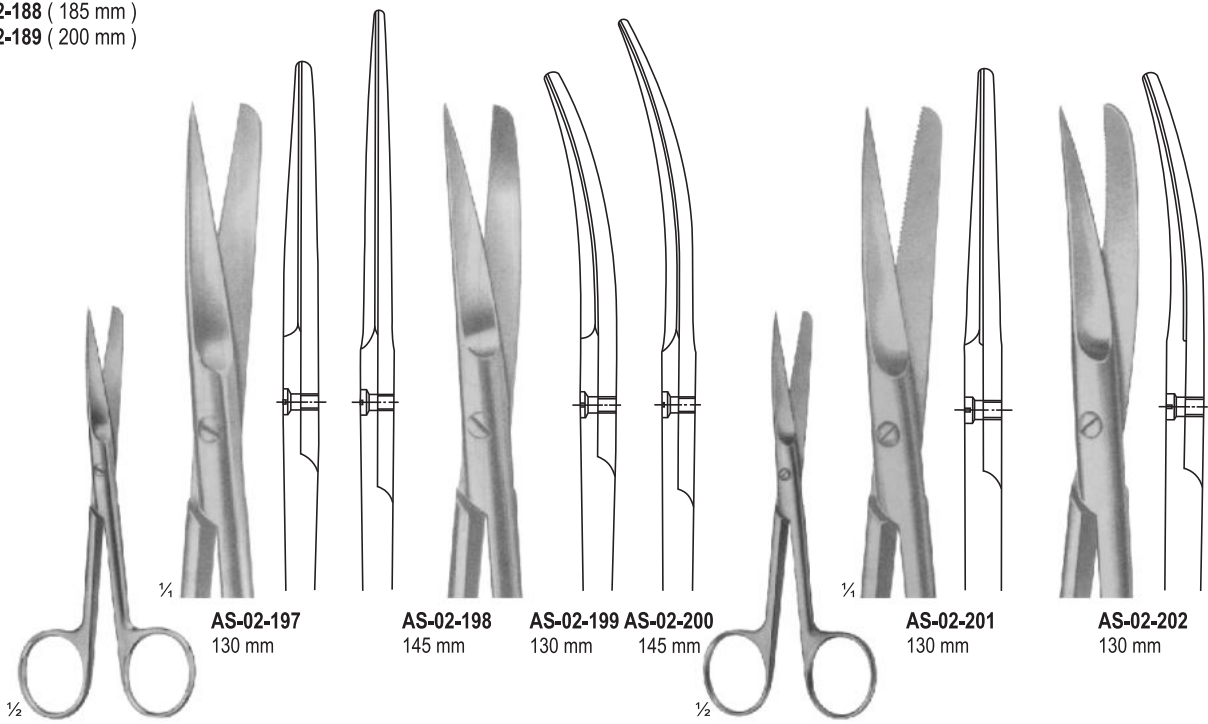

AS-02-197 - AS-02-200
 Slender Types

AS-02-197 130 mm

AS-02-198 145 mm

AS-02-199 130 mm

AS-02-200 145 mm

AS-02-201 - AS-02-202
 For Wound Edges
 1 Blade Serrated

AS-02-201 130 mm

AS-02-202 130 mm

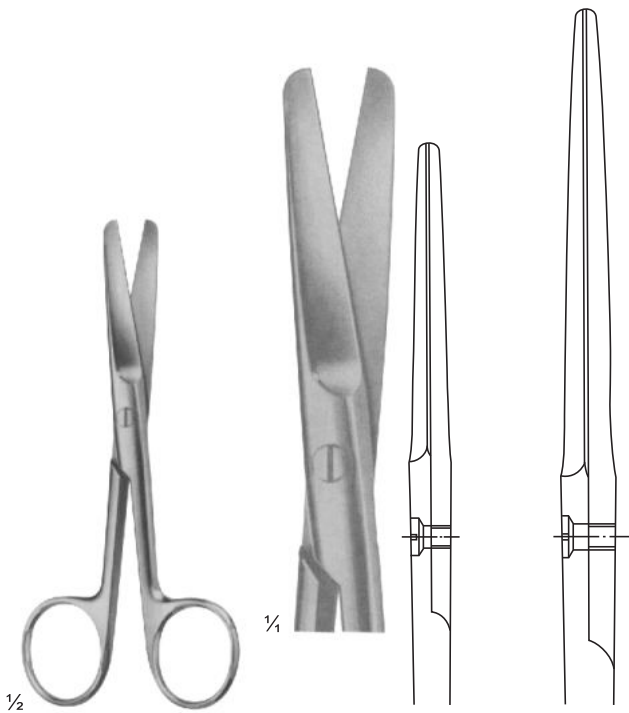

AS-02-203 - AS-02-207
(Standard Types)
AS-02-203 (130 mm)
AS-02-204 (145 mm)
AS-02-205 (150 mm)
AS-02-206 (165 mm)
AS-02-207 (175 mm)

AS-02-203
130 mm

AS-02-207
175 mm

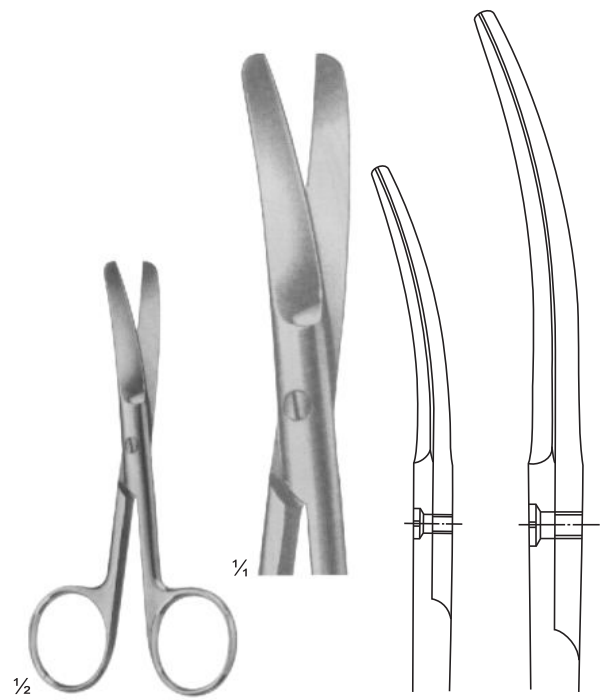

AS-02-208 - AS-02-213 - COOPER Standard Types
AS-02-208 (115 mm)
AS-02-209 (130 mm)
AS-02-210 (145 mm)
AS-02-211 (150 mm)
AS-02-212 (165 mm)
AS-02-213 (175 mm)

AS-02-208
115 mm

AS-02-213
175 mm

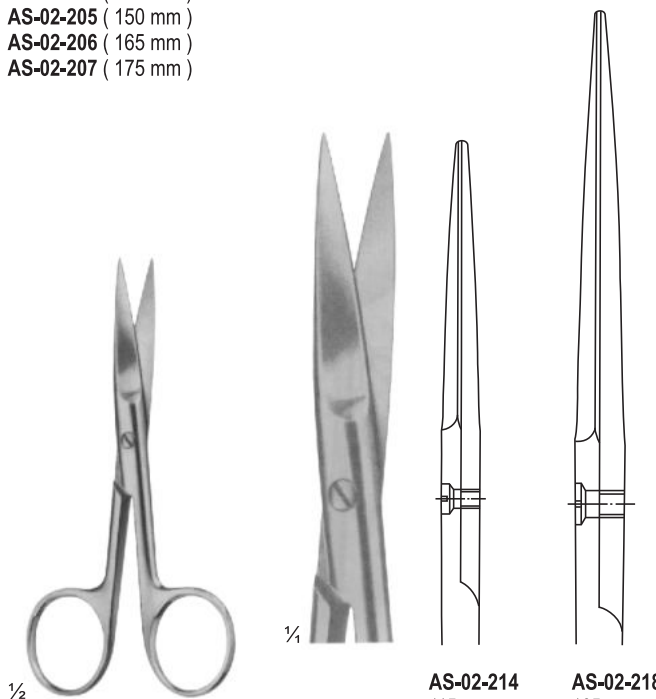

AS-02-214 - AS-02-218
Standard Types
AS-02-214 (115 mm)
AS-02-215 (130 mm)
AS-02-216 (145 mm)
AS-02-217 (150 mm)
AS-02-218 (165 mm)

AS-02-214
115 mm

AS-02-218
165 mm

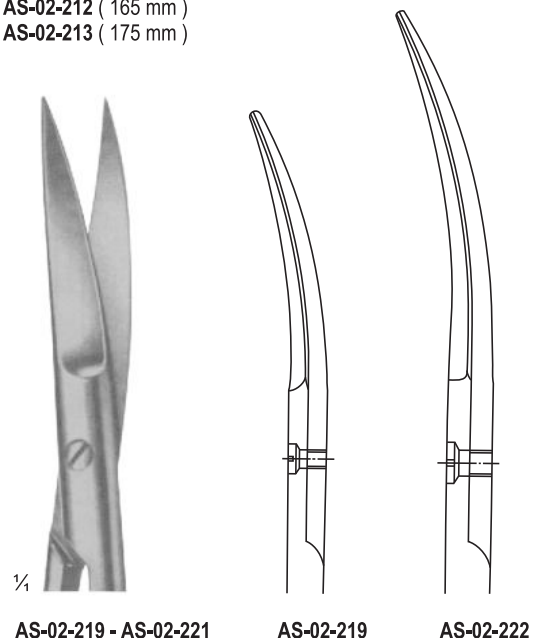

AS-02-219 - AS-02-221
Standard Types
AS-02-219 (115 mm)
AS-02-220 (130 mm)
AS-02-221 (145 mm)
AS-02-222 (150 mm)

AS-02-219
115 mm

AS-02-222
150 mm

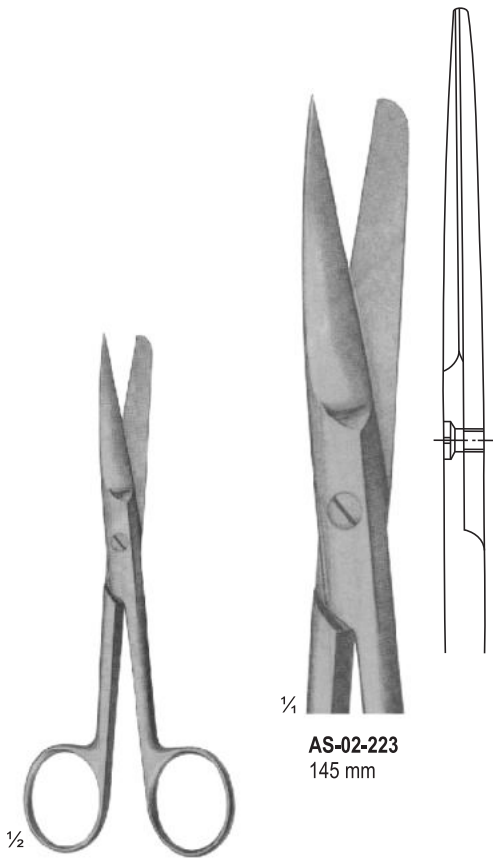

1/4
AS-02-223
145 mm

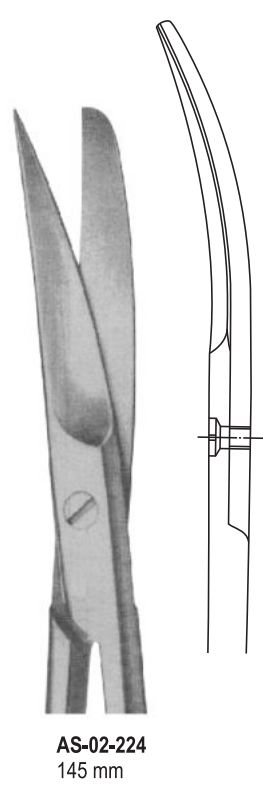

AS-02-224
145 mm

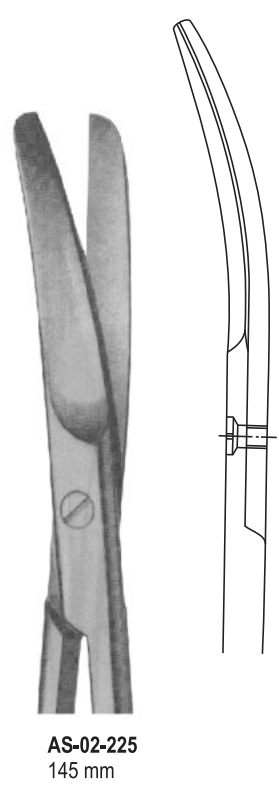

AS-02-225
145 mm

AS-02-223 - AS-02-225
DEAVER
With flat lock

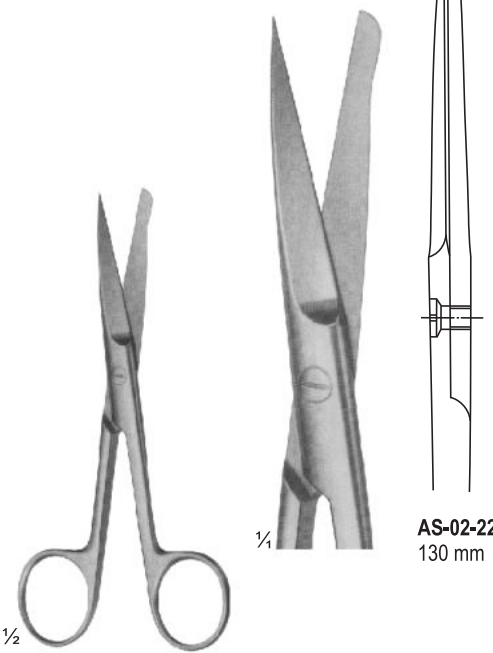

1/4
AS-02-226
130 mm



AS-02-227
145 mm

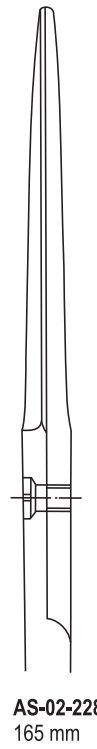

AS-02-228
165 mm

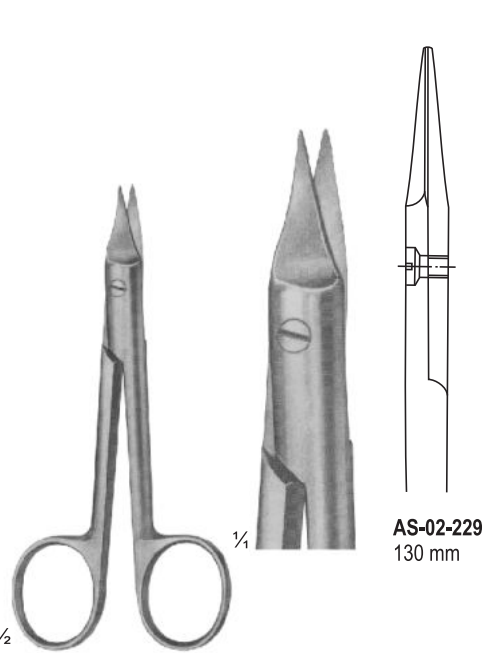

1/2
AS-02-229
SYSTRUNK
Nail Splitting
Scissors

1/4
AS-02-229
130 mm

AS-02-226 - AS-02-228
Incision Scissors

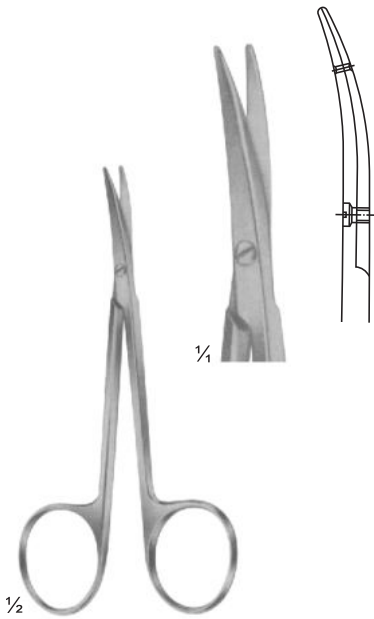

AS-02-230 LITTLER
Dissecting Scissors
Tips with eye for
suture 115 mm

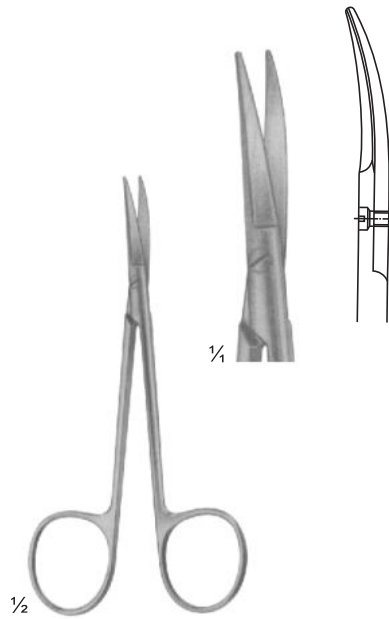

AS-02-231
COTTLE
Bulldog
Scissors 115
mm

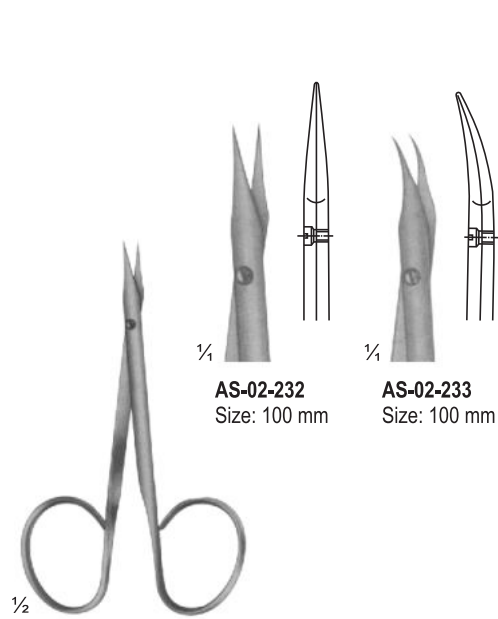

AS-02-232
Size: 100 mm

AS-02-233
Size: 100 mm

AS-02-232 - AS-02-233
STEVENS
Vessel and tendon
Scissors 100 mm

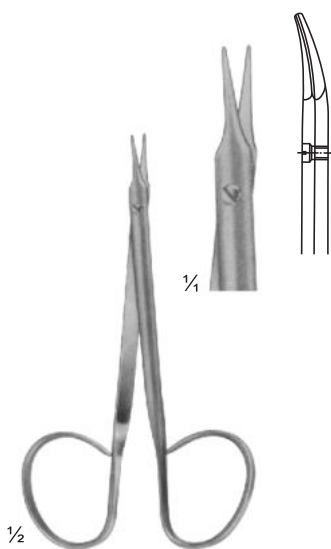

AS-02-234 STEVENS
Fine Dissecting
Scissors 110 mm

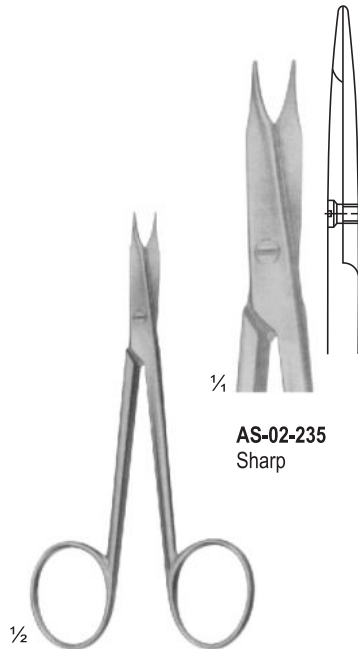

AS-02-235 - AS-02-238
STEVENS
Vessel and tendon
Scissors 110 mm

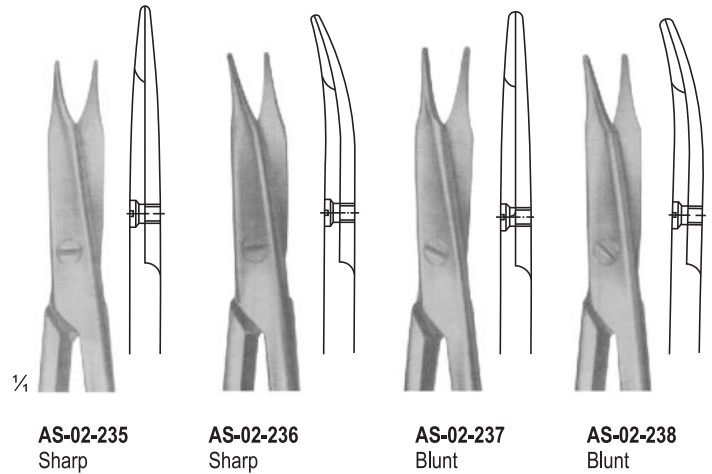

AS-02-235
Sharp

AS-02-236
Sharp

AS-02-237
Blunt

AS-02-238
Blunt

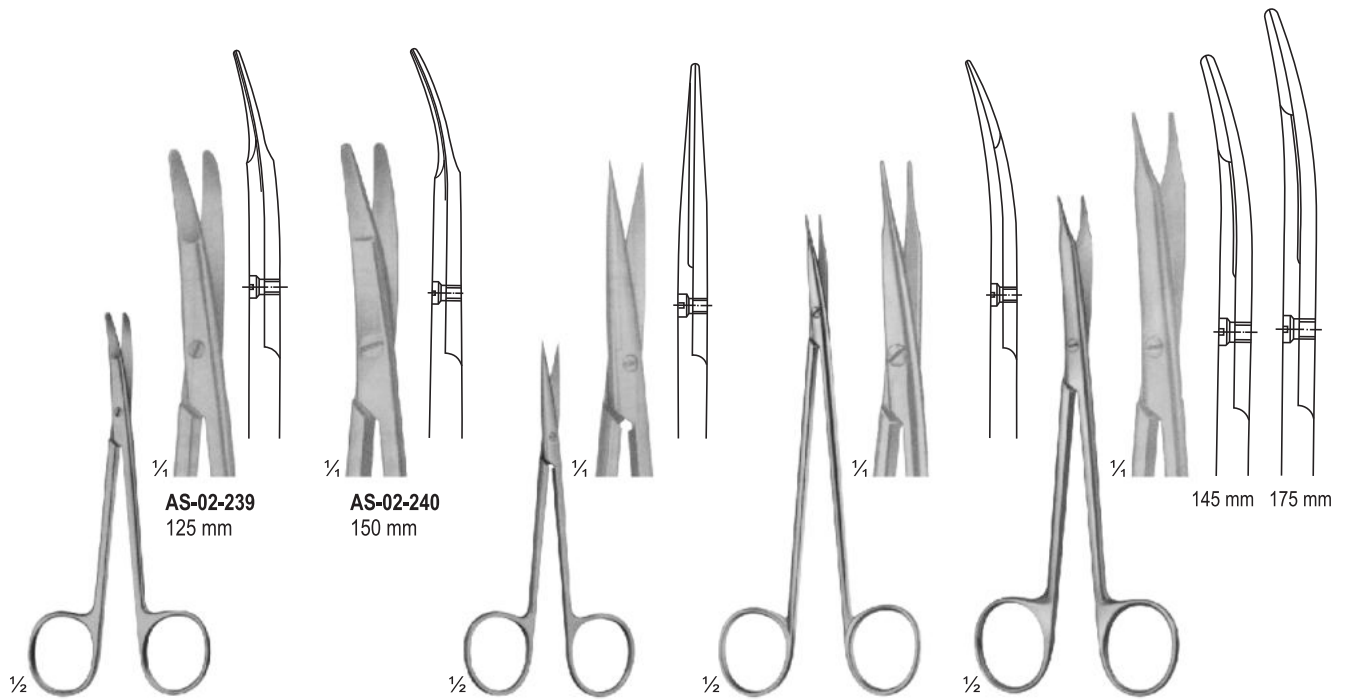

AS-02-239 - AS-02-240
KILNER
 Special flat points for
 dissecting and undermining the
 skin

AS-02-241 KILNER
 Fine dissecting
 scissors 115 mm

AS-02-242
JAMESON
 Dissecting
 scissors 150 mm

AS-02-243
REYNOLDS
 Dissecting
 scissors 145 -
 175 mm

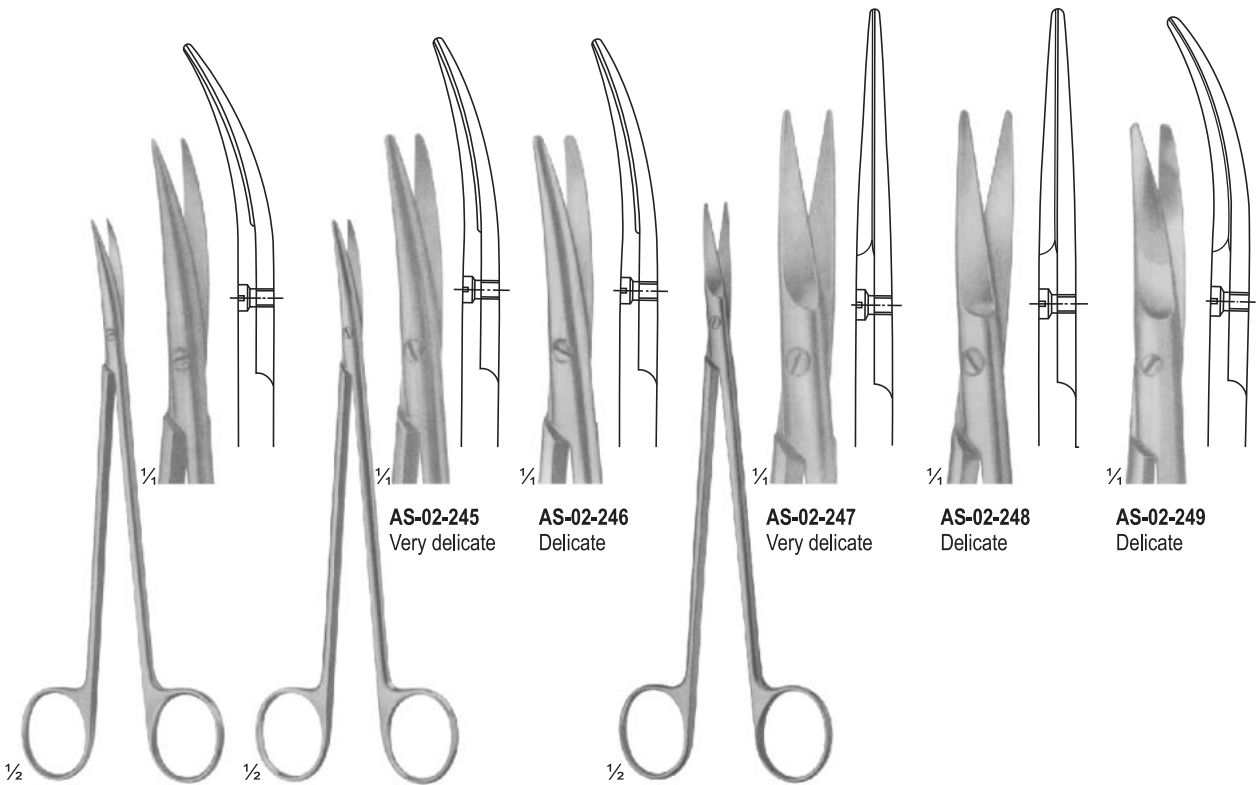

AS-02-244
DE BAKEY
 Ateriotomy
 scissors 175 mm

AS-02-245 - AS-02-246
TOENNIS ADSON
 Dissecting scissors
 175 mm

AS-02-247 - AS-02-249
TOENNIS
 Dissecting scissors
 150 mm

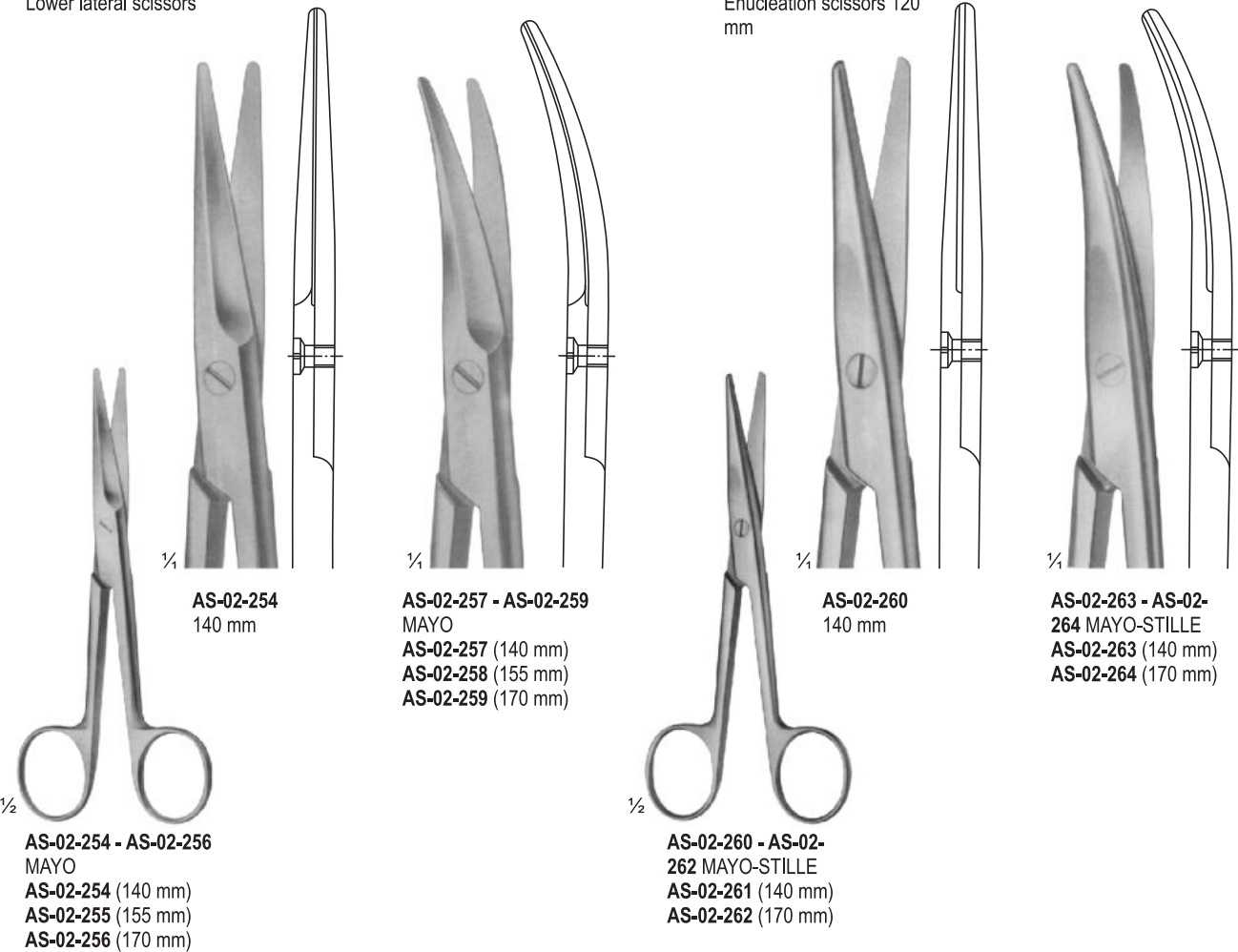
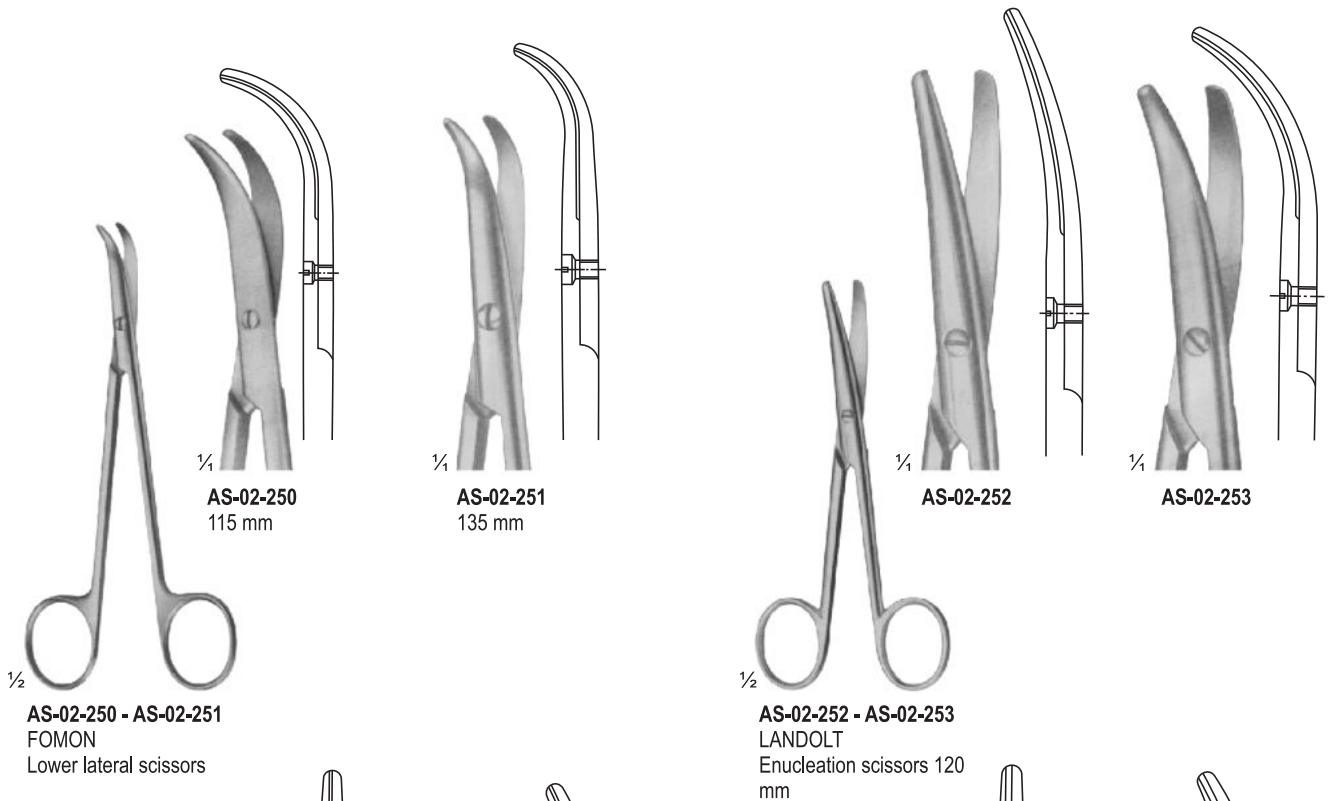

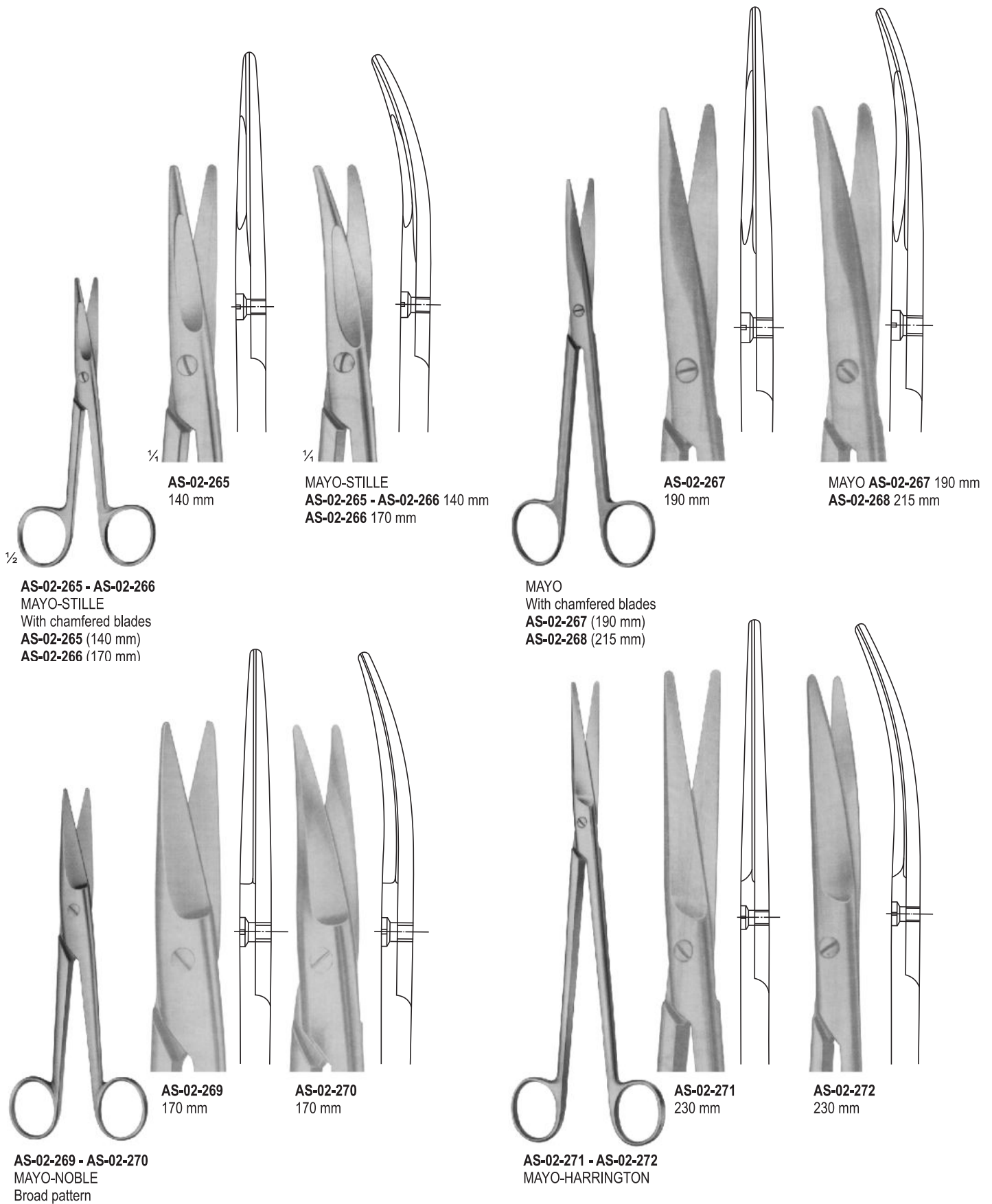

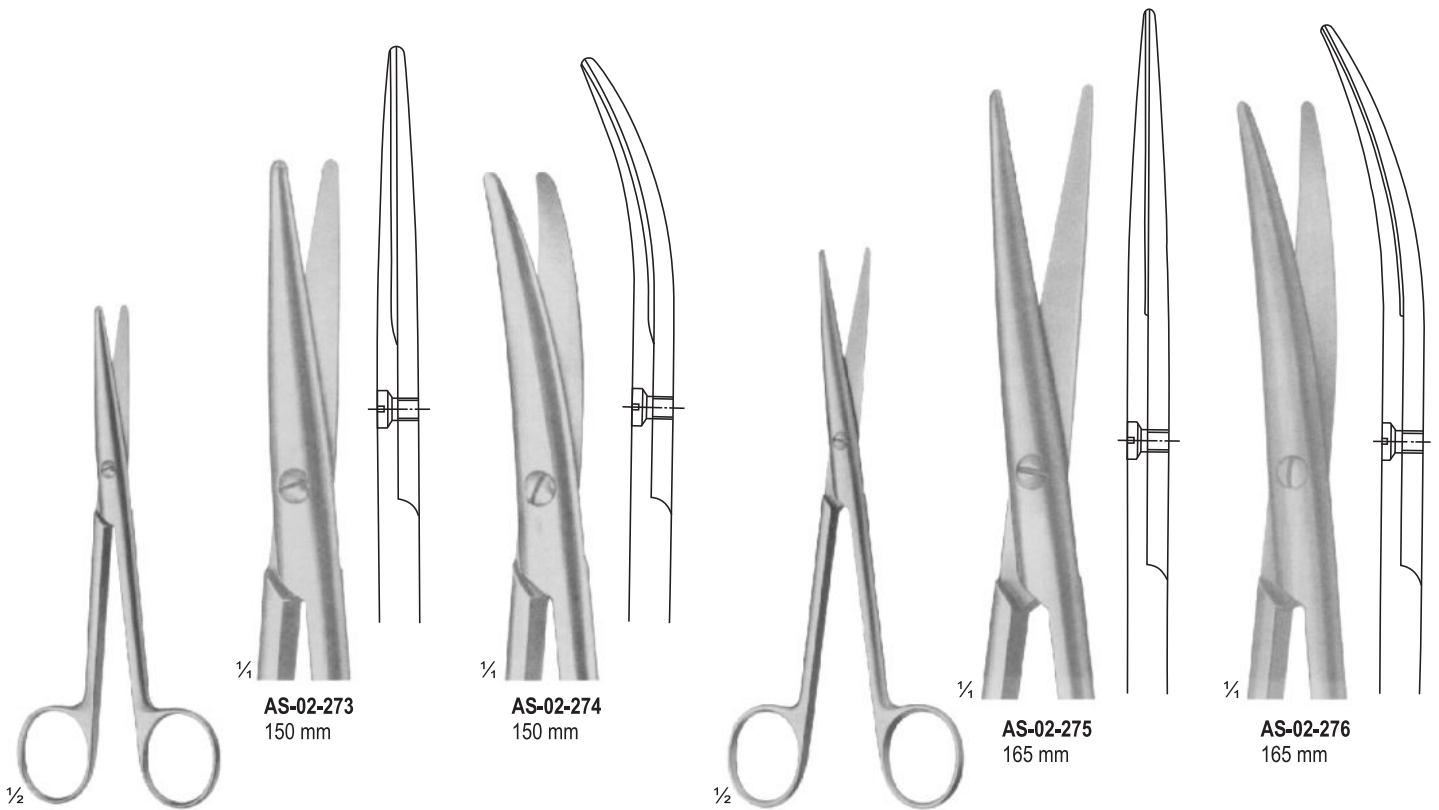

AS-02-273 - AS-02-274
STILLE
150 mm

AS-02-275 - AS-02-276
LEXER Narrow
165 mm

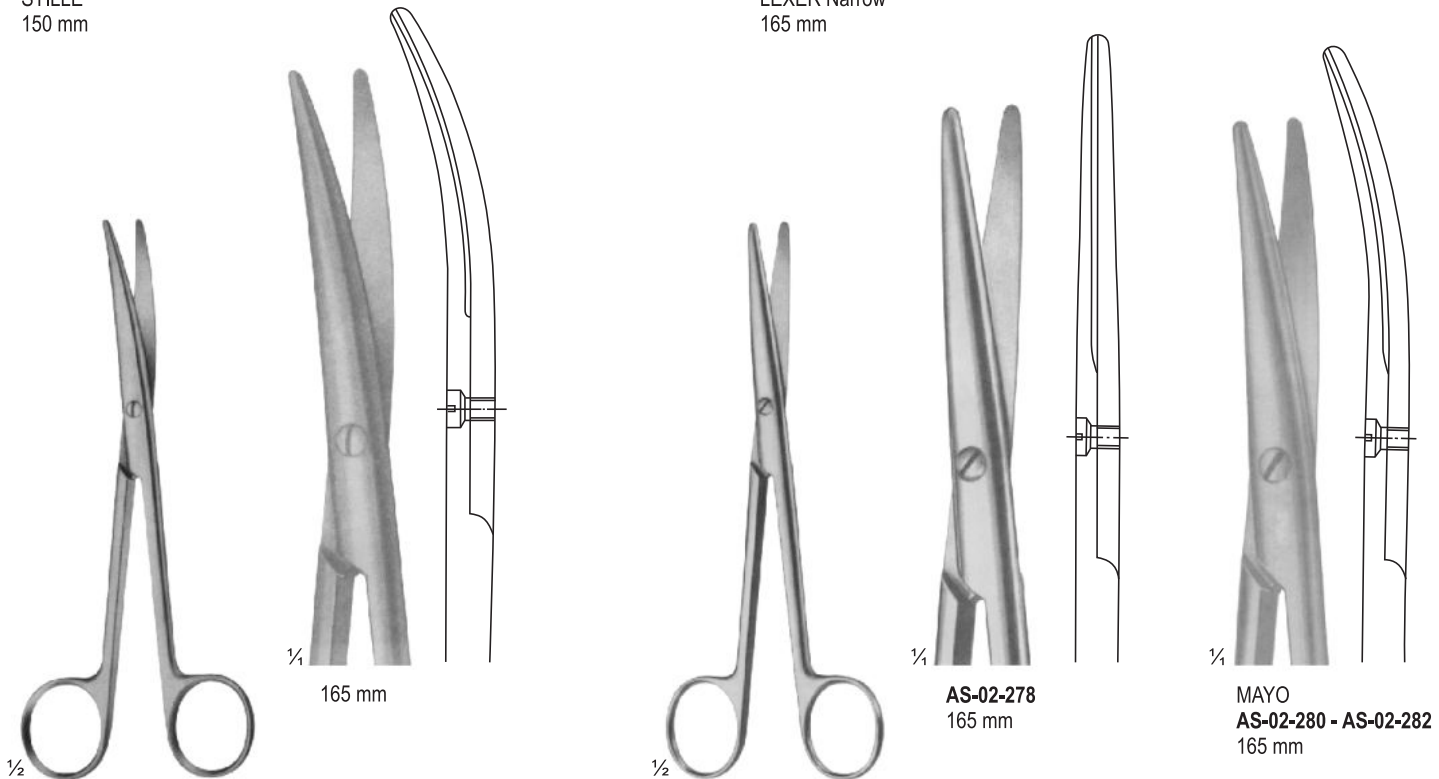

AS-02-277
MAYO-LEXER
Standard

AS-02-278 - AS-02-279
MAYO
AS-02-278 (165 mm)
AS-02-279 (200 mm)

MAYO
AS-02-280 - AS-02-282
165 mm

AS-02-281
200 mm
AS-02-282
210 mm

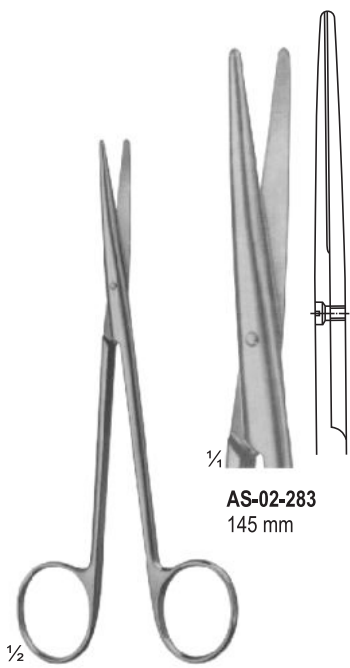

AS-02-283
145 mm

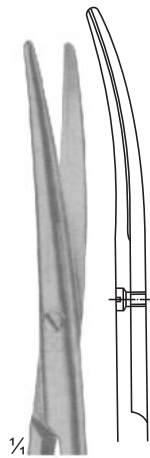

AS-02-284
145 mm

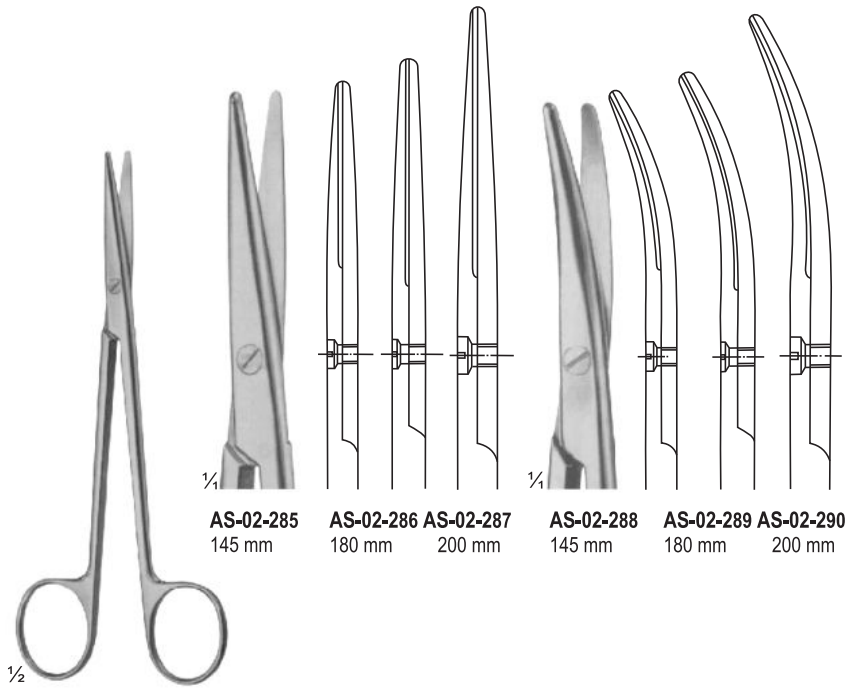

AS-02-285
145 mm

AS-02-286
180 mm

AS-02-287
200 mm

AS-02-288
145 mm

AS-02-289
180 mm

AS-02-290
200 mm

AS-02-283 - AS-02-284
BABY - METZENBAUM

AS-02-285 - AS-02-290
METZENBAUM

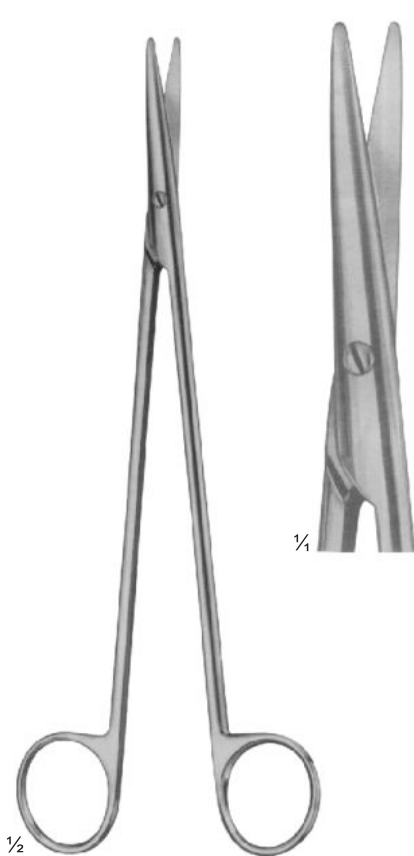

AS-02-291 - AS-02-298
NELSON - METZENBAUM

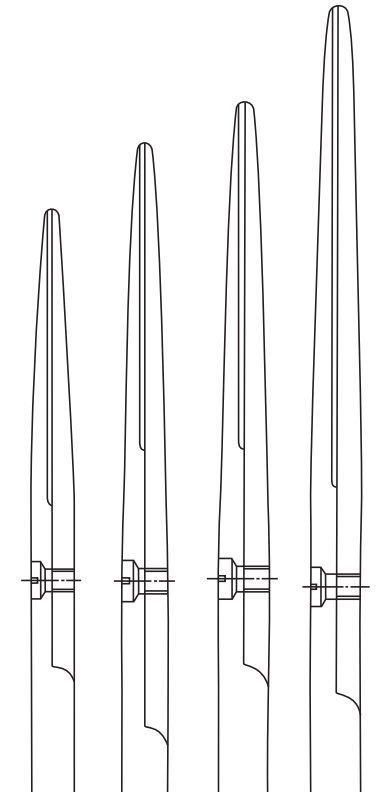

AS-02-291 AS-02-292 AS-02-293 AS-02-294
230 mm 250 mm 280 mm 305 mm

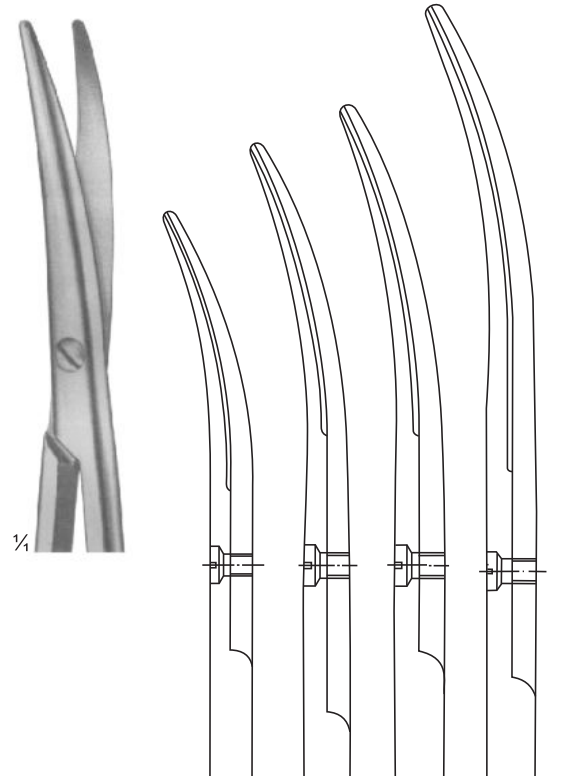

AS-02-295 AS-02-296 AS-02-297 AS-02-298
230 mm 250 mm 280 mm 305 mm

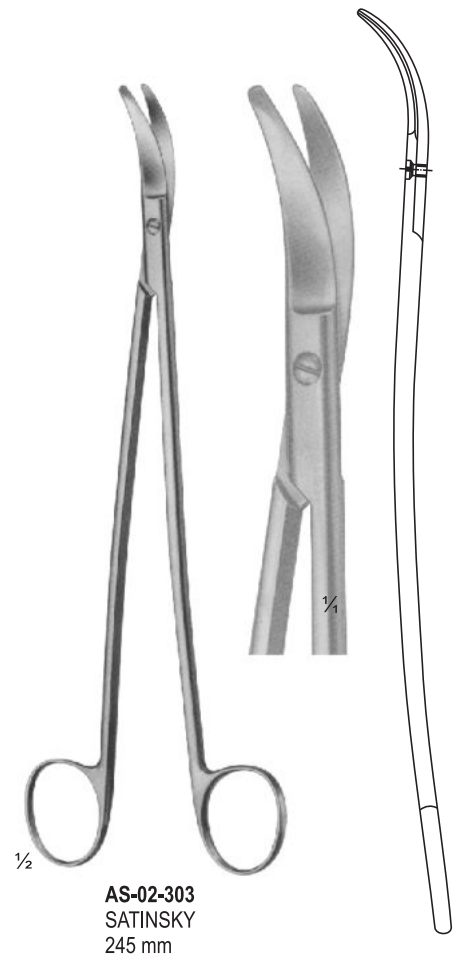
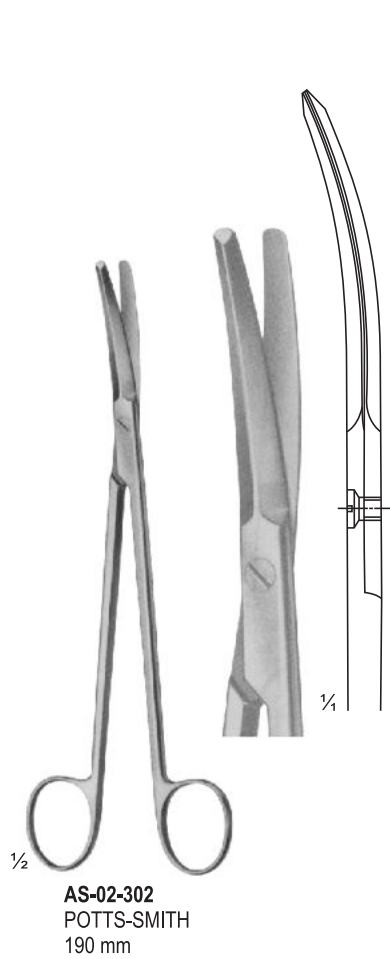
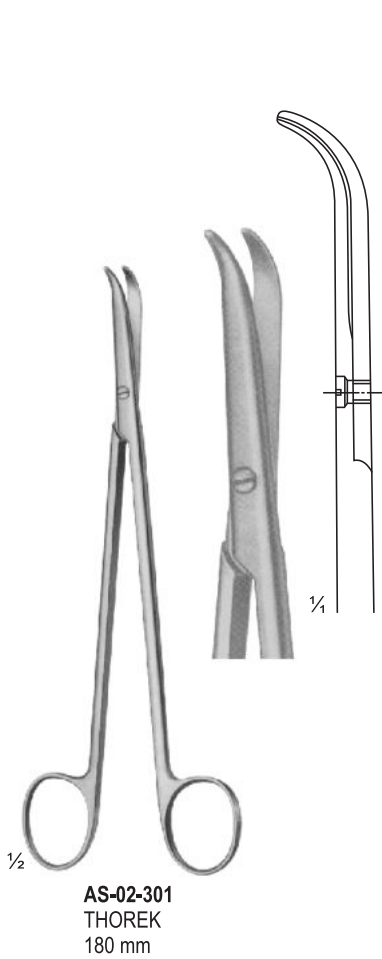
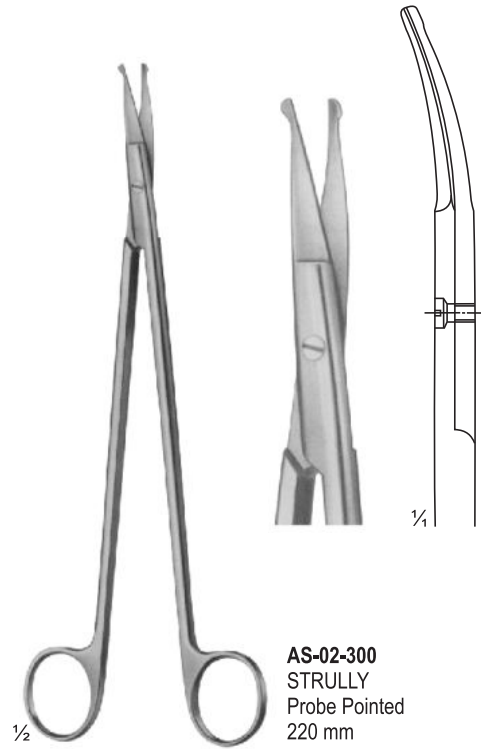
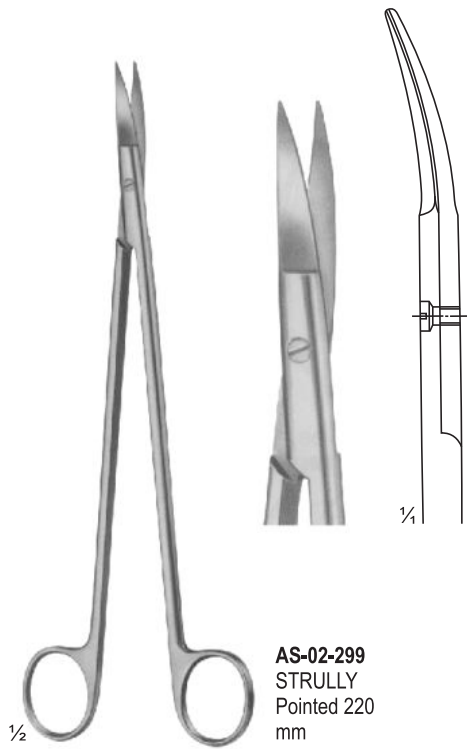

DELICATE, NASAL AND TONSIL SCISSORS

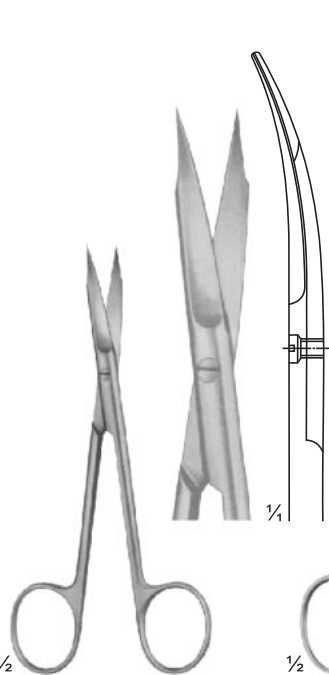

1/2
AS-02-304 Goldman-Fox
1 Finaly Toothed Blade
130 mm

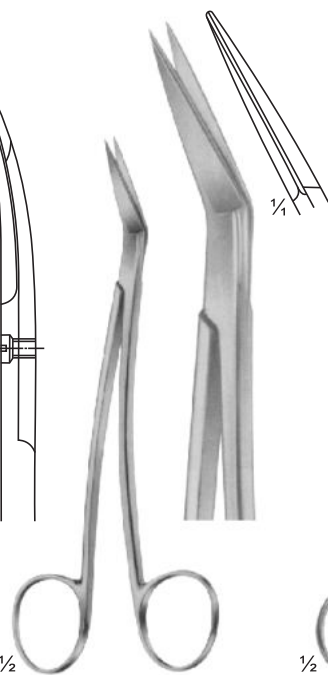

1/2
AS-02-305 LOCKLIN
Curved Sideways,
1 Toothed Blade
155 mm

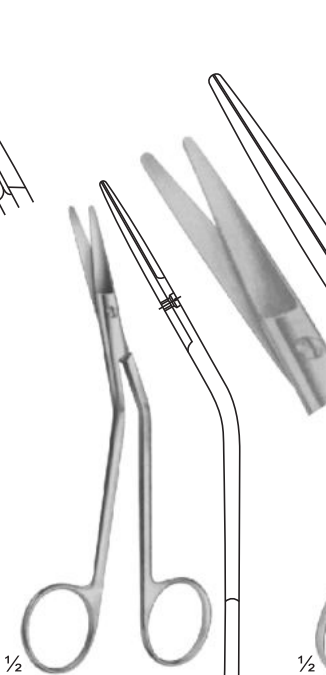

1/2
AS-02-306 FOMON
Blades Serrated
145 mm

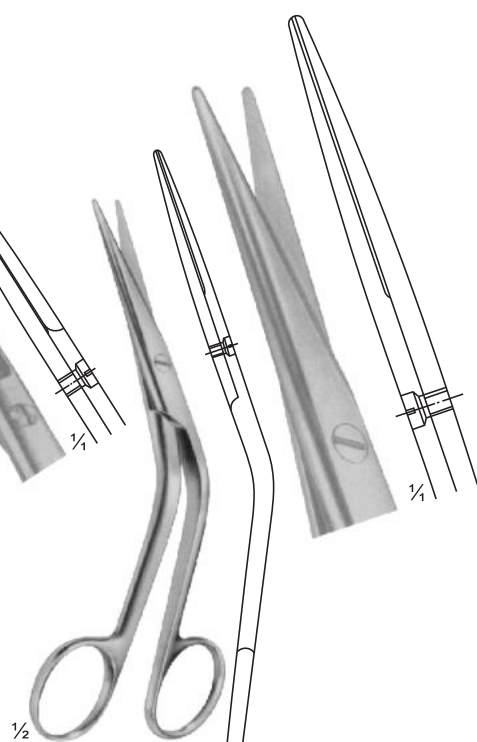

1/2
AS-02-307 COTTLE
165 mm

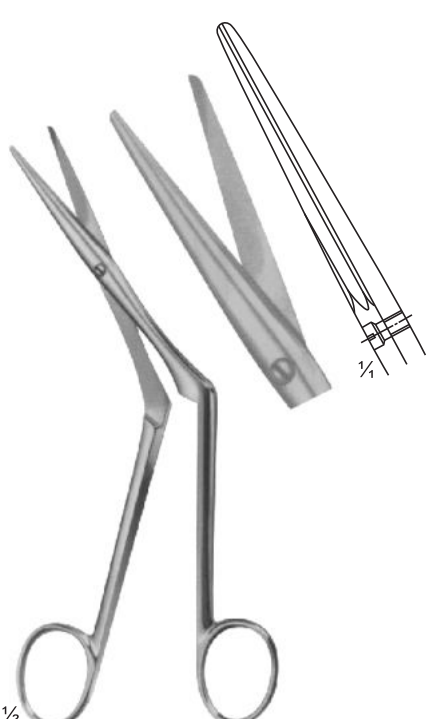

1/2
AS-02-308 HEYMANN-KNIGHT
175 mm

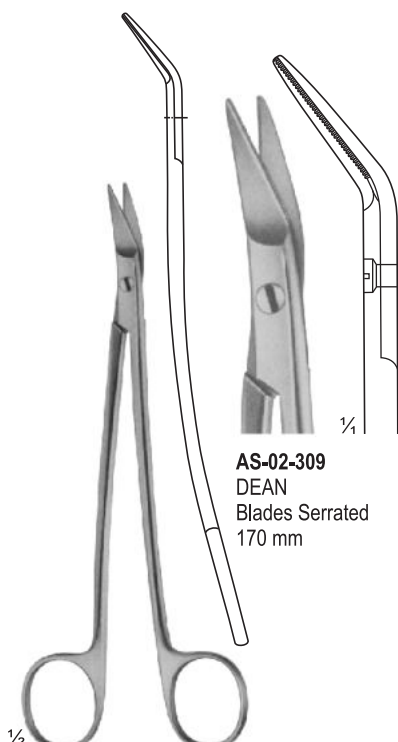

1/2
AS-02-309 DEAN
Blades Serrated
170 mm

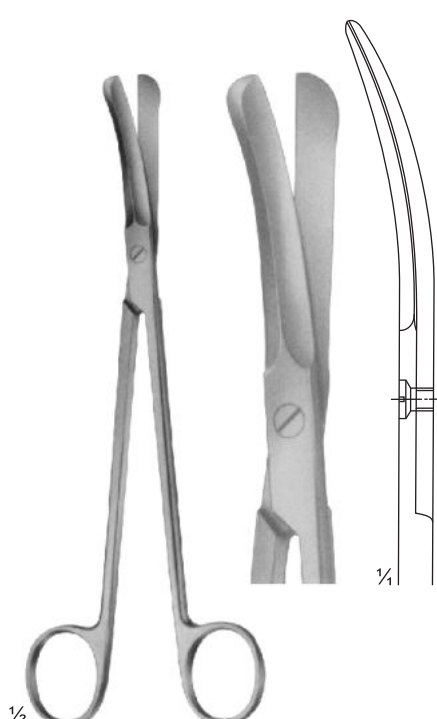

1/2
AS-02-310 GOOD
195 mm

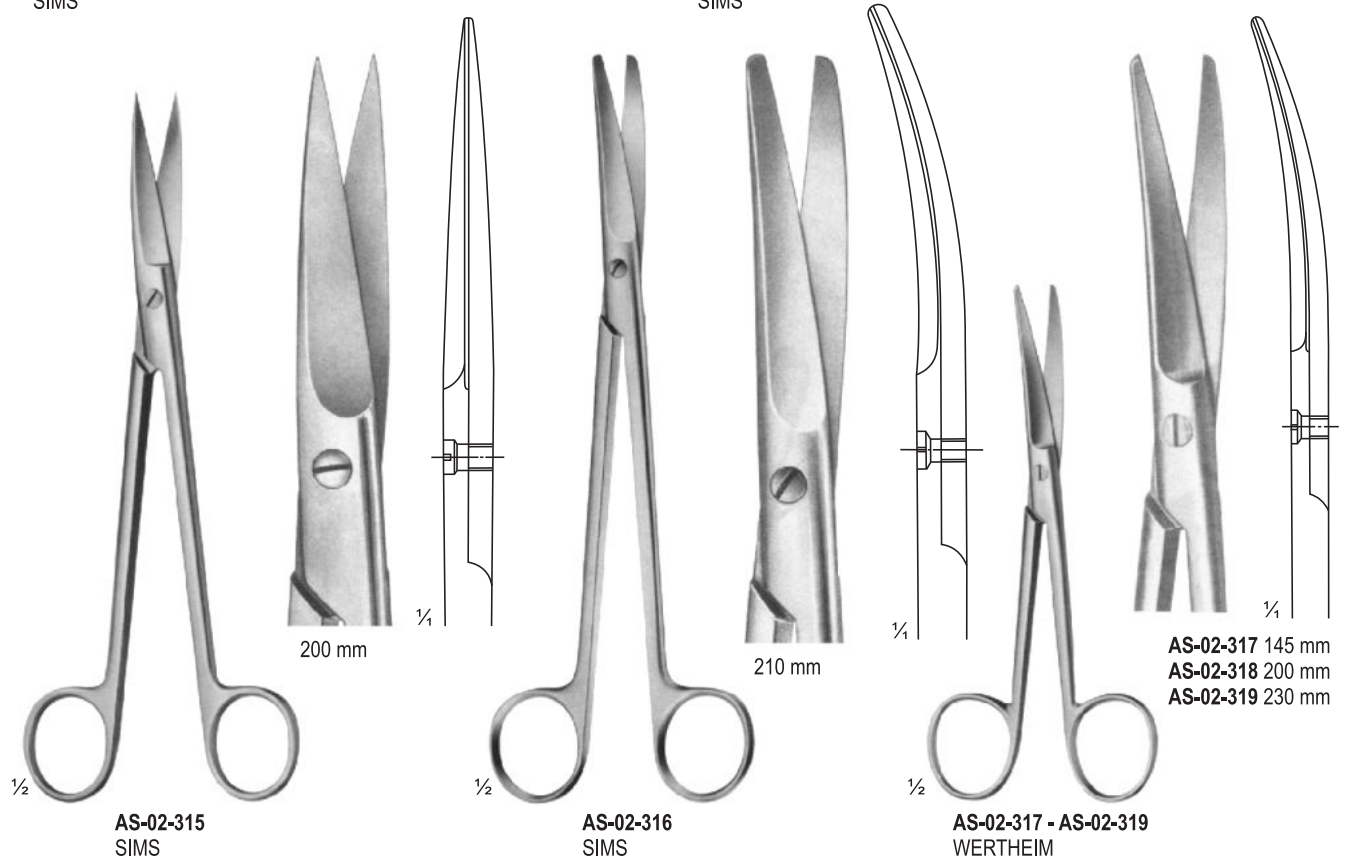
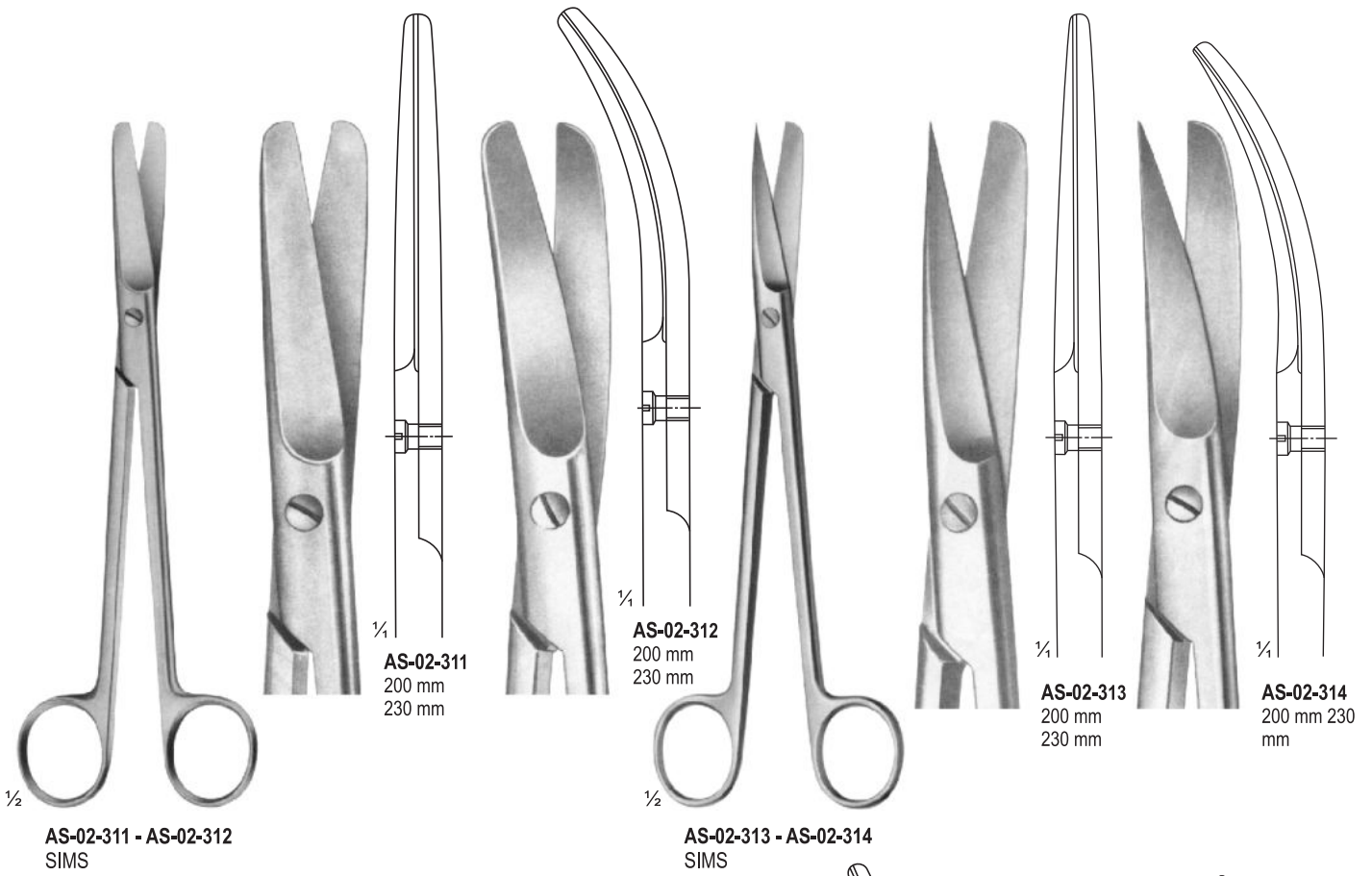



AS-02-320
SIEBOLD
Uterine
Scissors 245
mm

AS-02-321
BOZEMANN
Uterine
Scissors 220
mm

AS-02-322
SIMS-SIEBOLD
Uterine
Scissors 250
mm

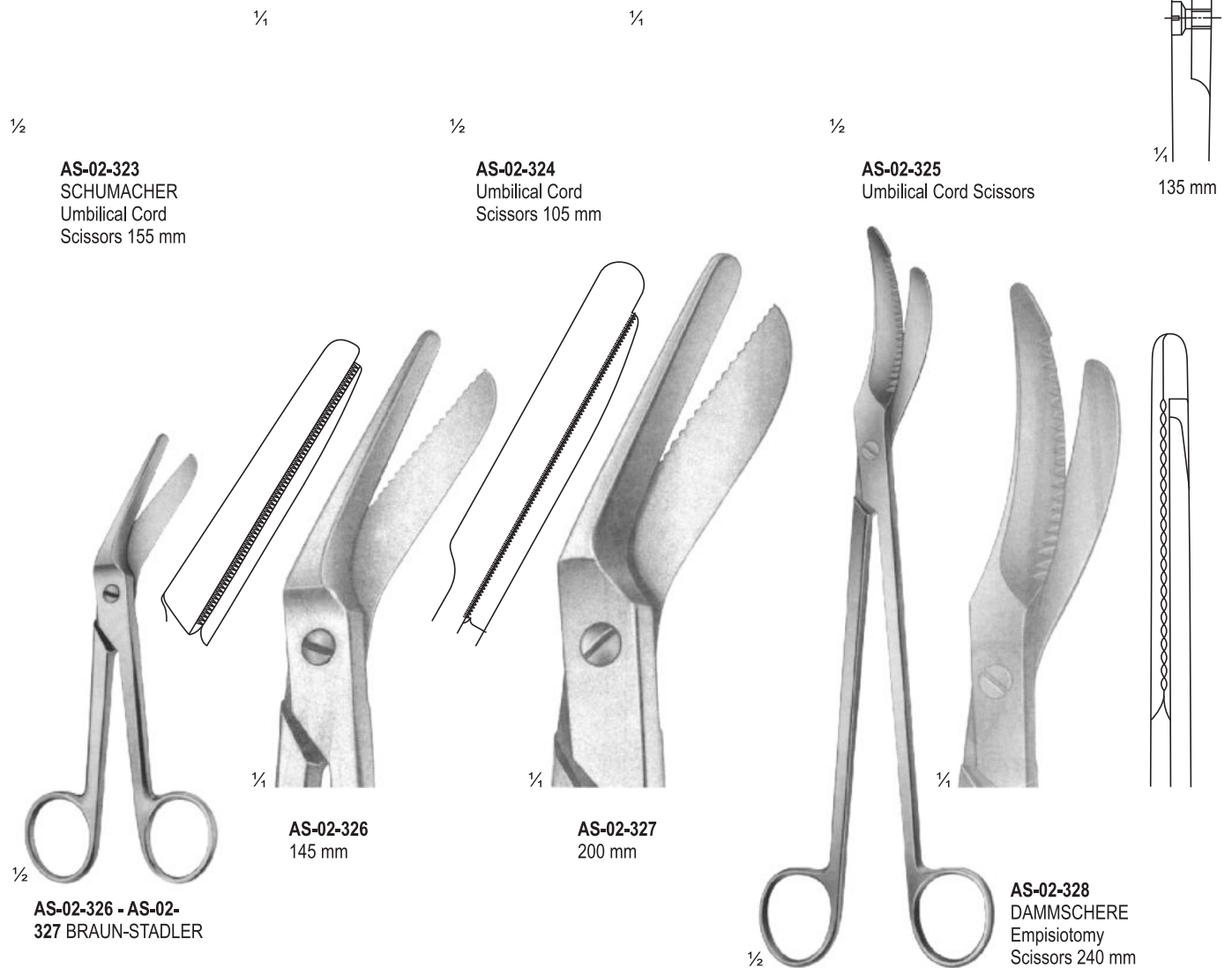

AS-02-323
SCHUMACHER
Umbilical Cord
Scissors 155 mm

AS-02-324
Umbilical Cord
Scissors 105 mm

AS-02-325
Umbilical Cord Scissors
135 mm

AS-02-326
145 mm

AS-02-327
200 mm

AS-02-328
DAMMSCHERE
Empisiotomy
Scissors 240 mm

AS-02-326 - AS-02-327
BRAUN-STADLER

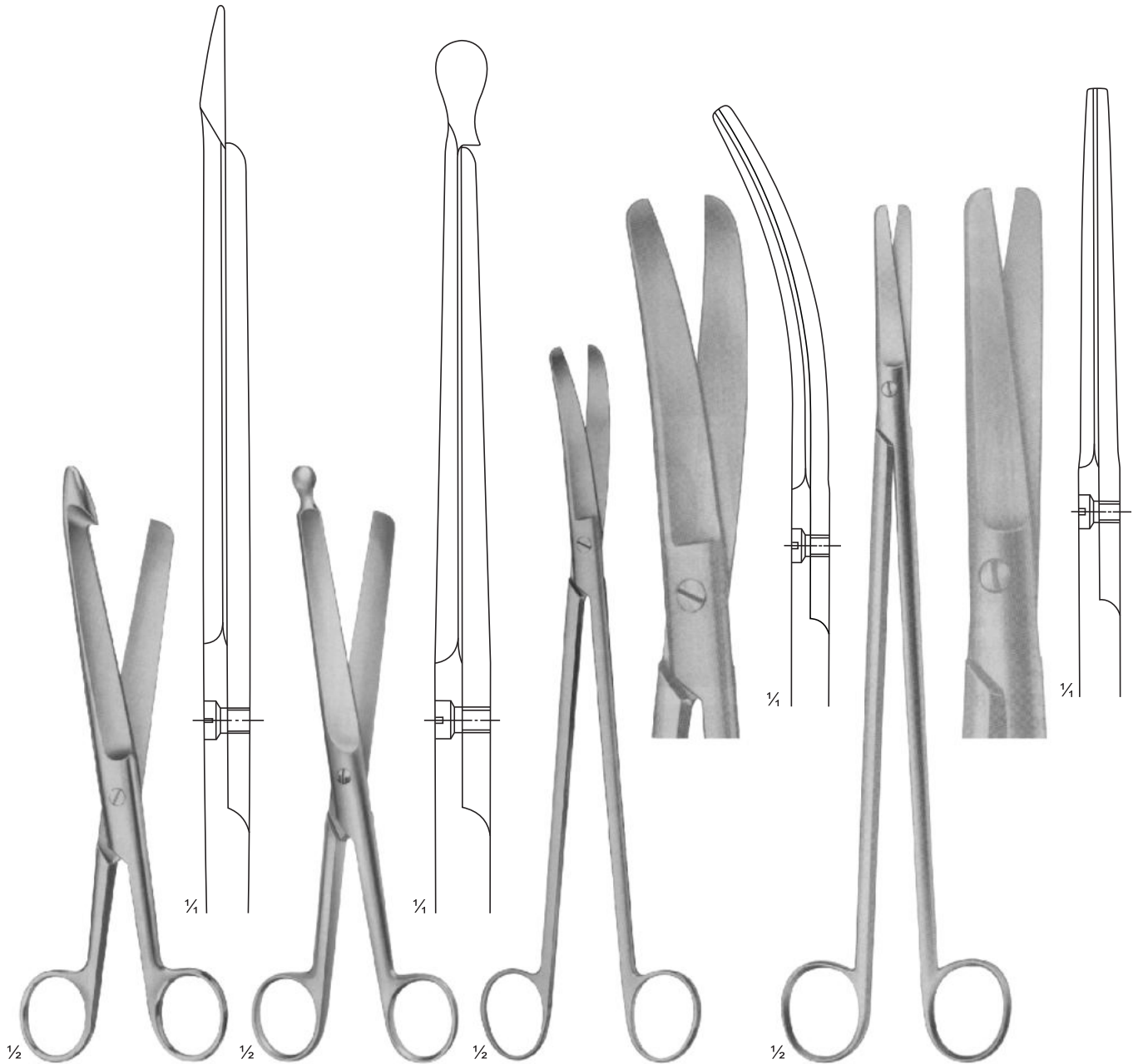

AS-02-329
DAMMSCHERE
Bowel Scissors
210 mm

AS-02-330
DAMMSCHERE
Bowel Scissors
210 mm

AS-02-331
LLOYD-DAVIES
(GOLIGHER'S)
Rectal Scissors
255 mm

AS-02-332
STELZNER
Rectal
Scissors 310
mm

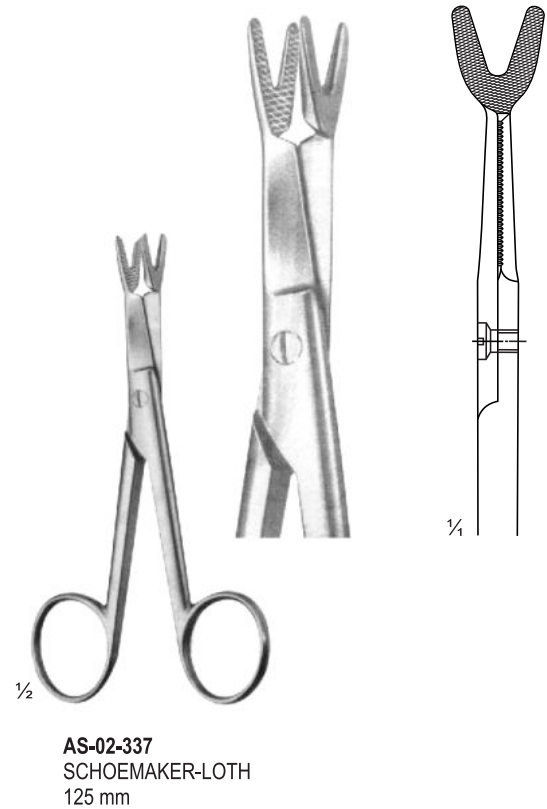
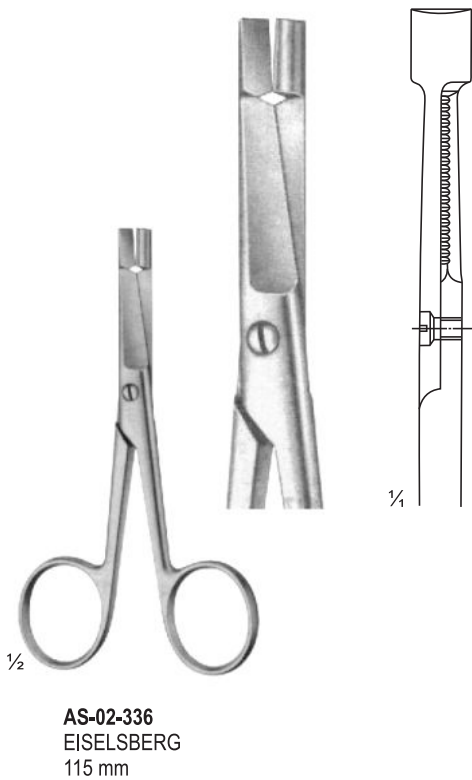
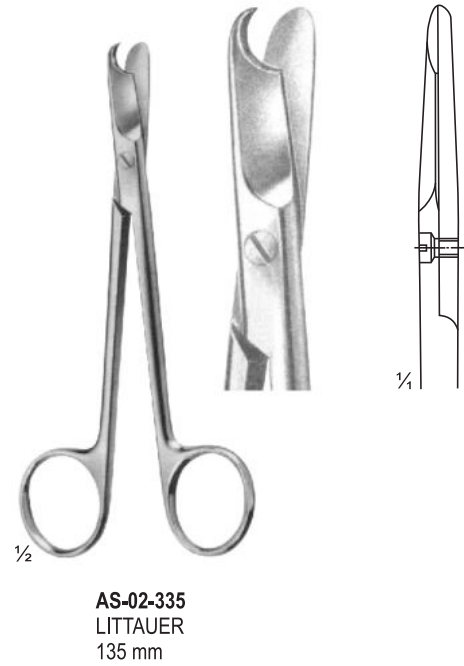



AS-02-338 - AS-02-342
BEEBE
110 mm

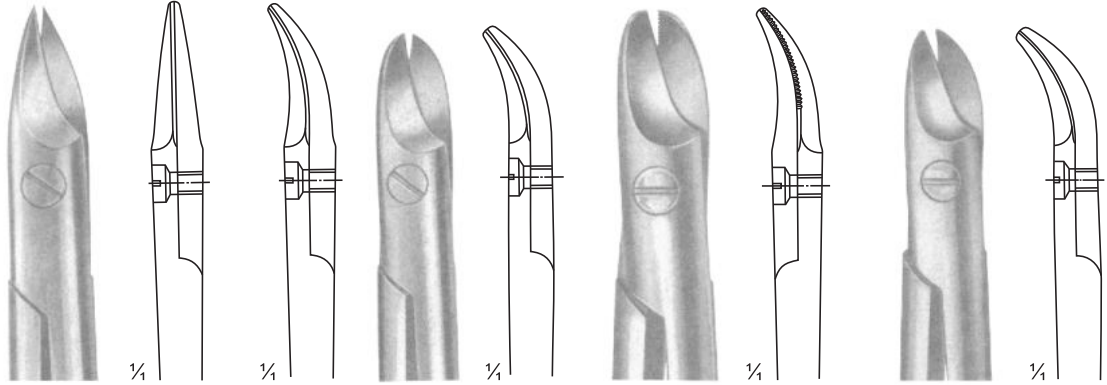

AS-02-338

AS-02-339 AS-02-340
Broad Blades

AS-02-341
1 Blade Serrated

AS-02-342
NAUJOKS
Strongly Curved

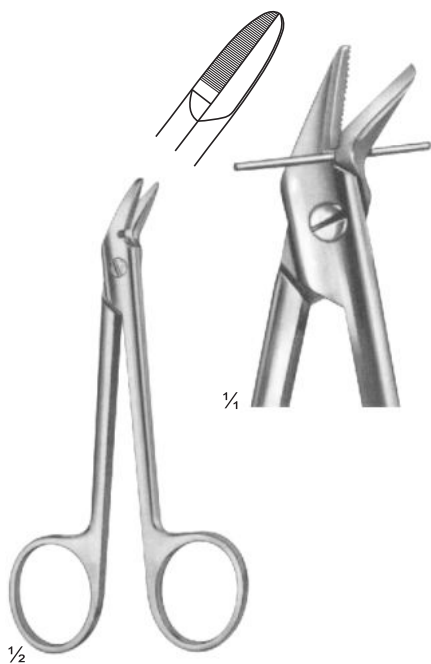

AS-02-343
1 Blade Serrated
120 mm

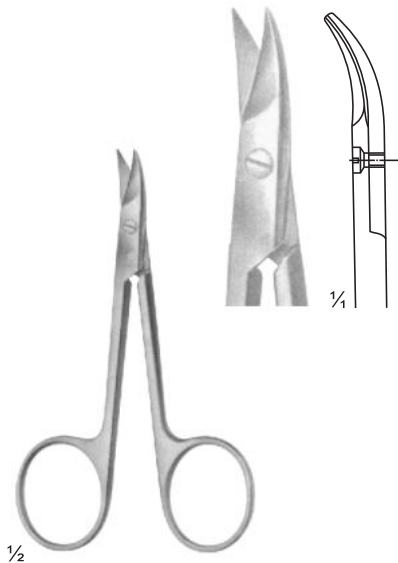

AS-02-344
STRACK
100 mm

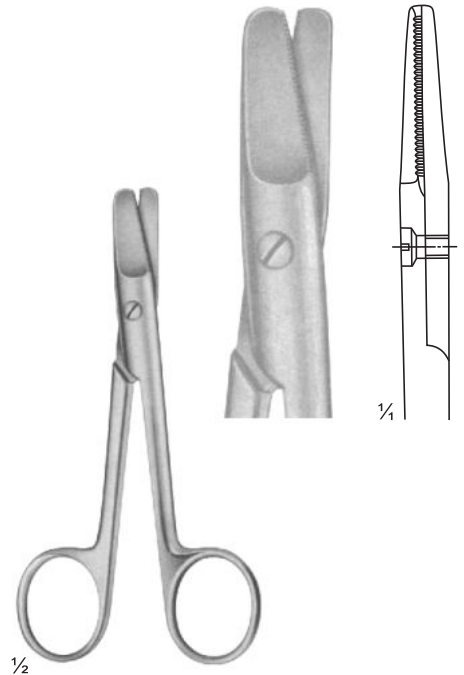

AS-02-345
HARVEY
125 mm

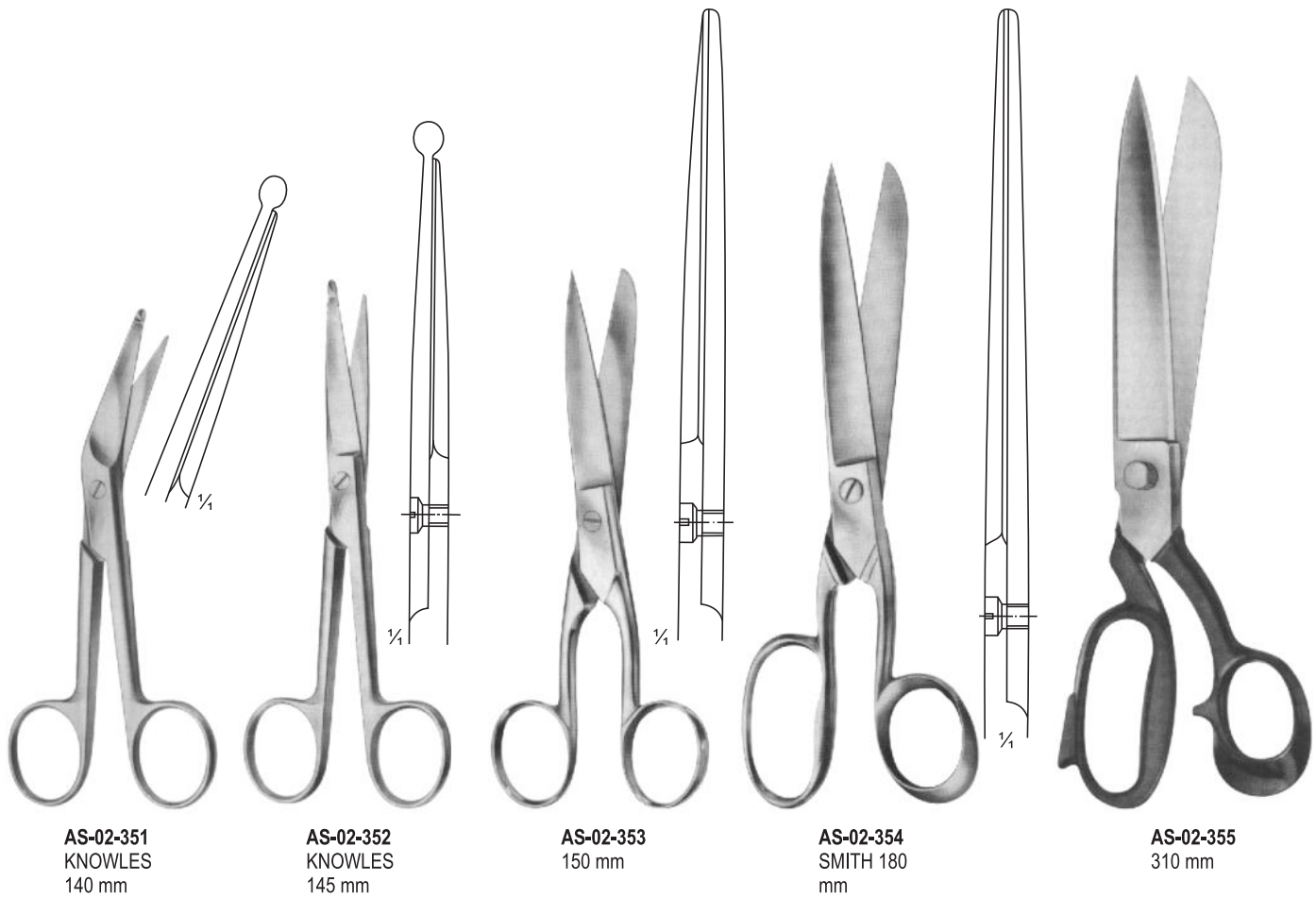
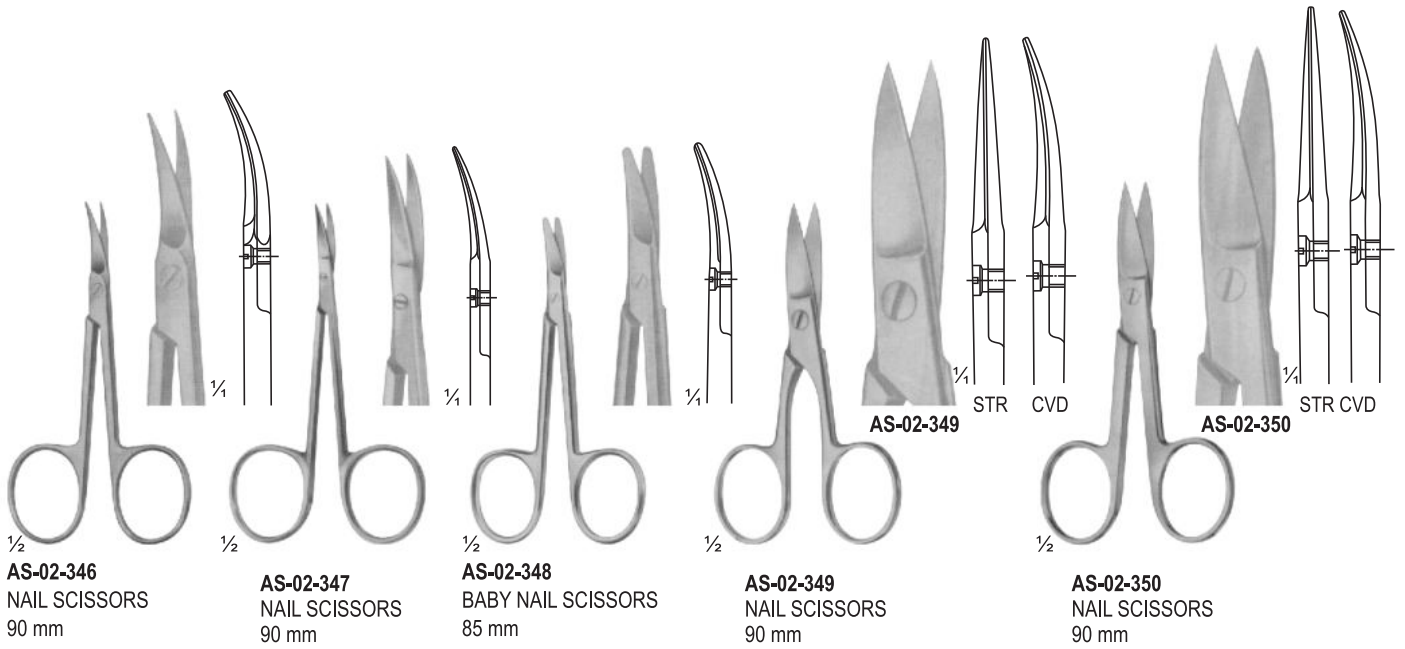

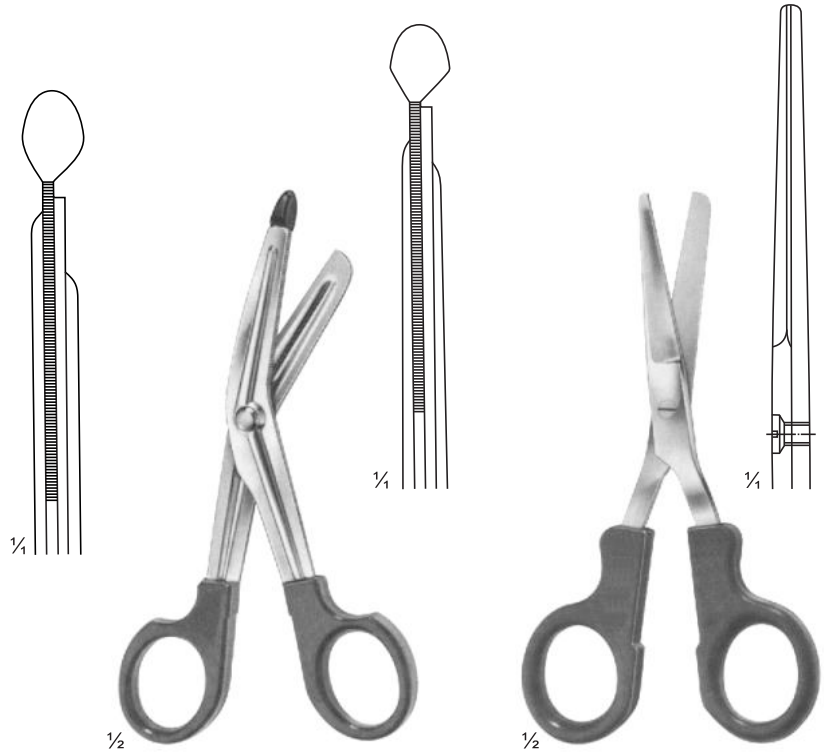

1/2

AS-02-356
UNIVERSAL AND BANDAGE SCISSORS
180 mm

1/2

AS-02-357
LISTER 145
mm

1/2

AS-02-358
LISTER 145
mm

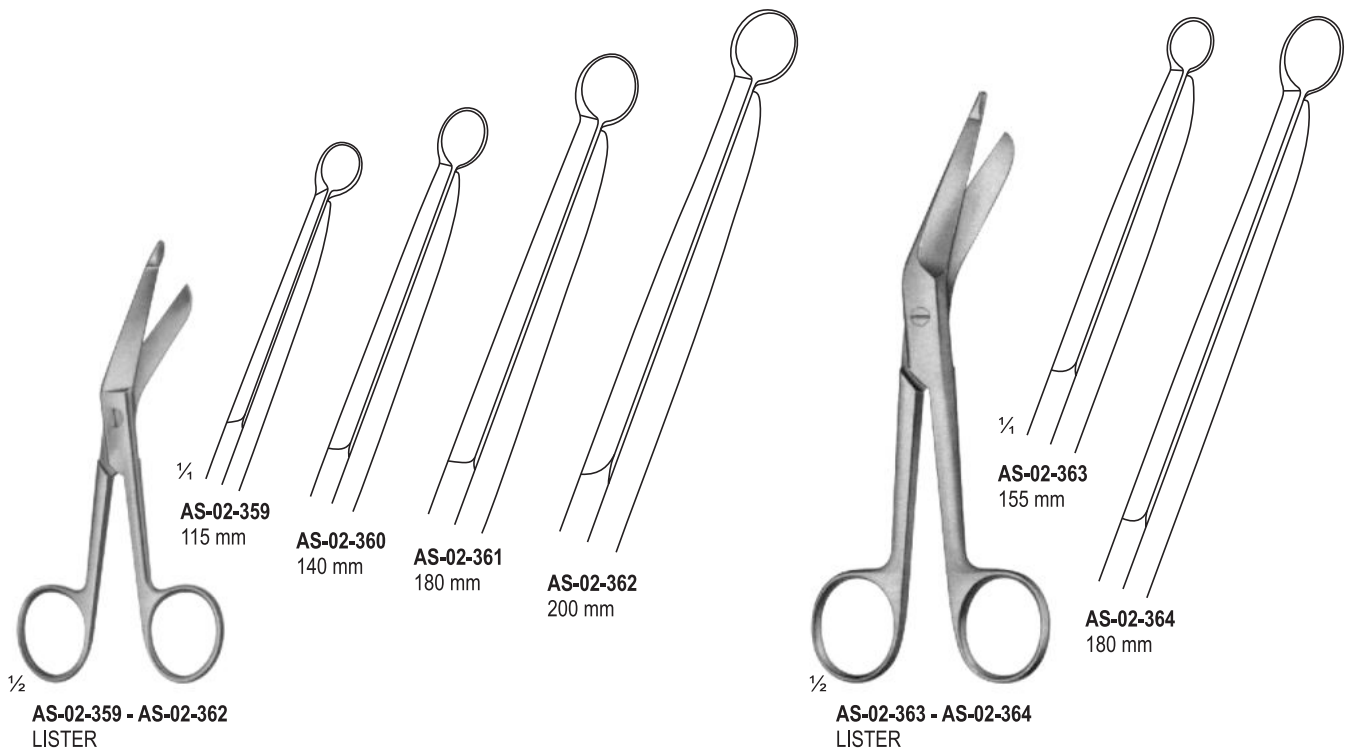

1/2

AS-02-359 - AS-02-362
LISTER

AS-02-359
115 mm

AS-02-360
140 mm

AS-02-361
180 mm

AS-02-362
200 mm

1/2

AS-02-363 - AS-02-364
LISTER

AS-02-363
155 mm

AS-02-364
180 mm



AS-02-365
CLOTH SCISSORS
205 mm

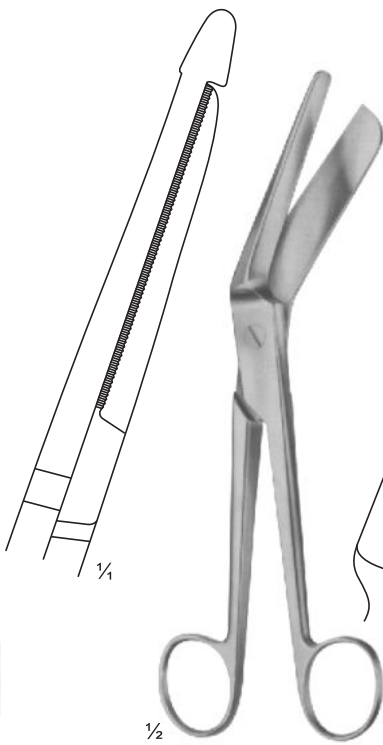

AS-02-366
BRAUN-STADLER
225 mm

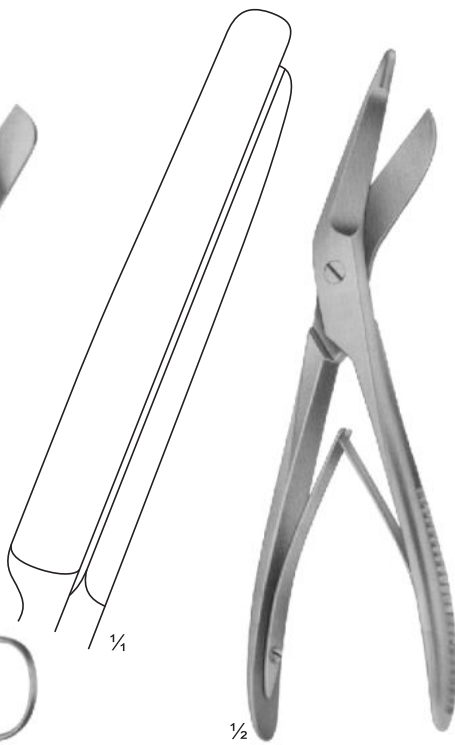

AS-02-367
SEUTIN 230 mm

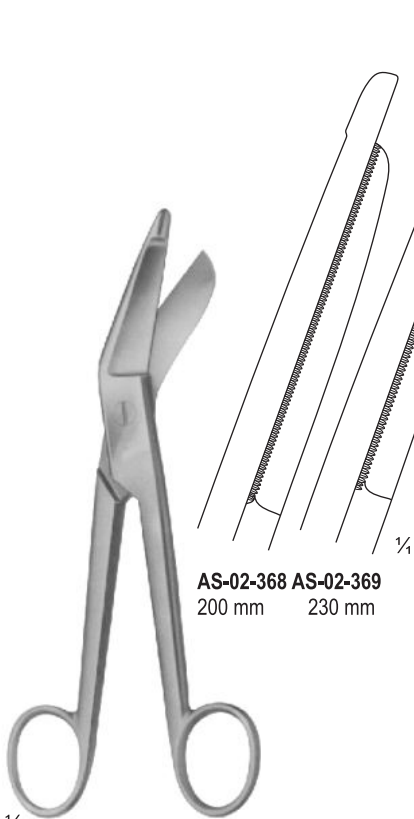
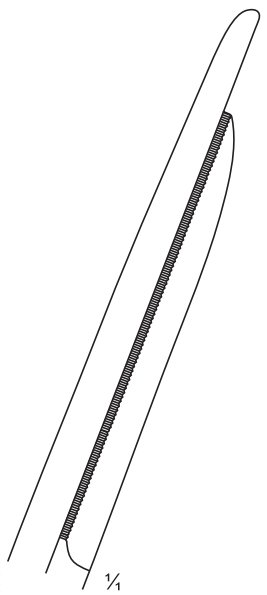

AS-02-368 AS-02-369
200 mm 230 mm

AS-02-368 - AS-02-369
ESMARCH

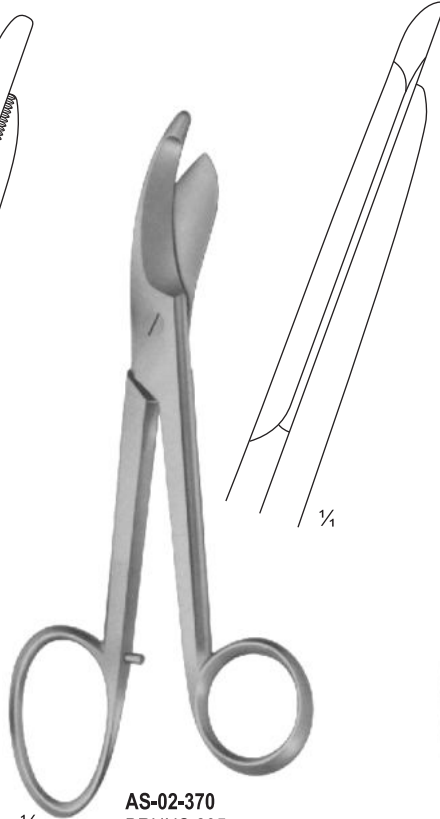

AS-02-370
BRUNS 235 mm

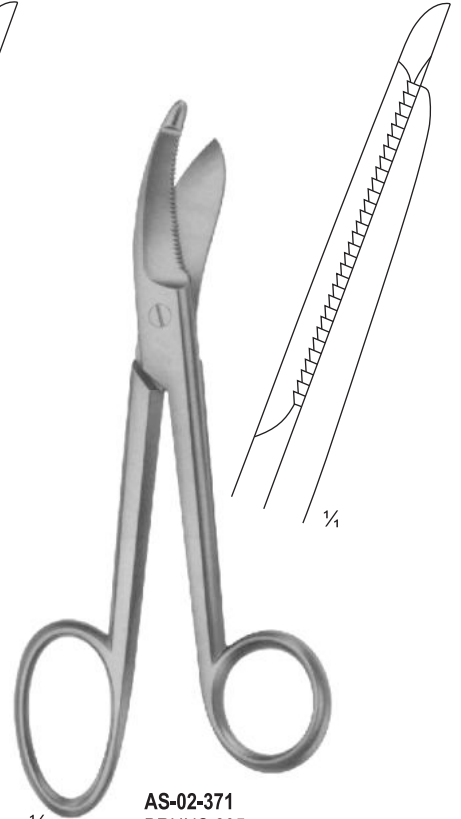

AS-02-371
BRUNS 235 mm

SURGICAL SCISSORS WITH TUNGSTEN CARBIDE EDGES



ASAMAR
SURGICAL



STANDARD
AS-02-372 14.5 cm, 5
 3/4" **AS-02-373** 16.5 cm,
 6 1/2" **AS-02-374** 18.5 cm,
 7 1/4"

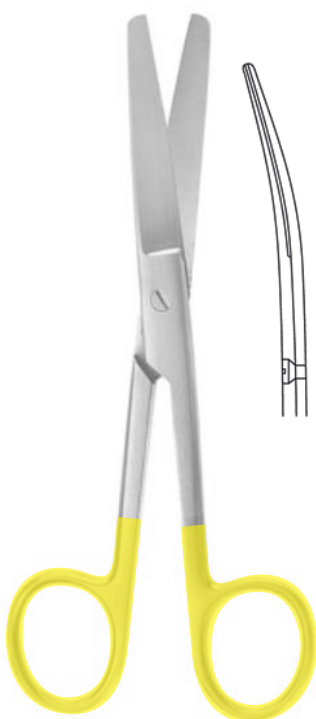

STANDARD
AS-02-375 14.5 cm, 5
 3/4" **AS-02-376** 16.5 cm,
 6 1/2" **AS-02-377** 18.5 cm,
 7 1/4"



STANDARD
AS-02-378 14.5 cm, 5
 3/4" **AS-02-379** 16.5 cm,
 6 1/2" **AS-02-380** 18.5 cm,
 7 1/4"



STANDARD
AS-02-381 14.5 cm, 5
 3/4" **AS-02-382** 16.5 cm,
 6 1/2" **AS-02-383** 18.5 cm,
 7 1/4"



STANDARD
AS-02-384 14.5 cm, 5
 3/4" **AS-02-385** 16.5 cm,
 6 1/2" **AS-02-386** 18.5 cm,
 7 1/4"

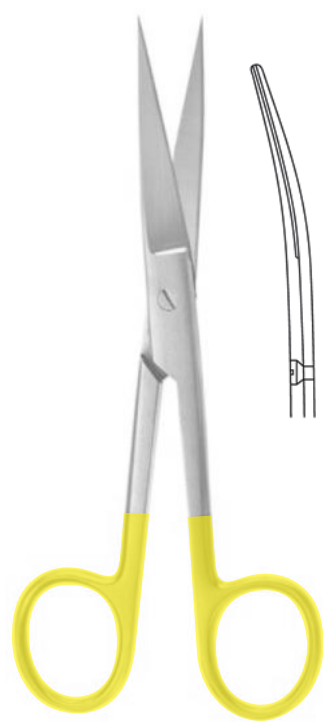

STANDARD
AS-02-387 14.5 cm, 5
 3/4" **AS-02-388** 16.5 cm,
 6 1/2" **AS-02-389** 18.5 cm,
 7 1/4"

SURGICAL SCISSORS WITH TUNGSTEN CARBIDE EDGES



ASAMAR
SURGICAL

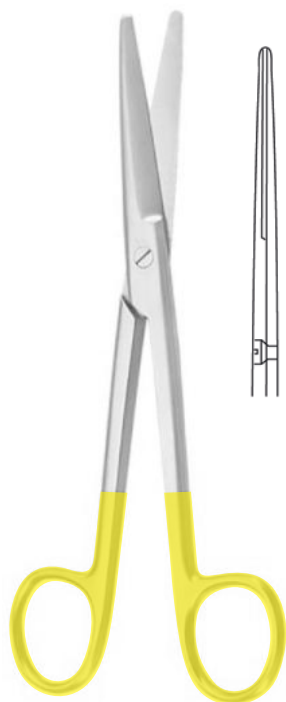

MAYO
AS-02-390 14.5 cm, 5
 3/4" **AS-02-391** 17.0 cm,
 6 3/4" **AS-02-392** 23.0
 cm, 9"



MAYO
AS-02-393 14.5 cm, 5
 3/4" **AS-02-394** 17.0 cm,
 6 3/4" **AS-02-395** 23.0
 cm, 9"

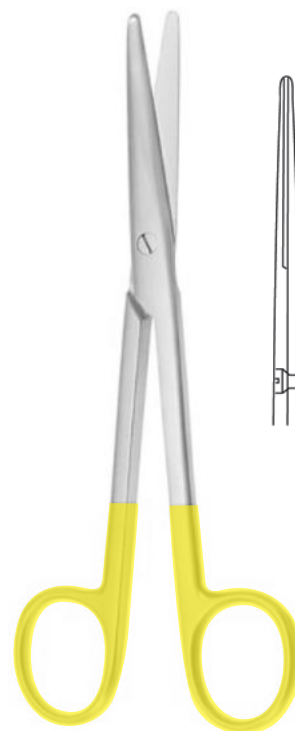

MAYO-STILLE
AS-02-396 15.0 cm, 6"
AS-02-397 17.0 cm, 6
 3/4"

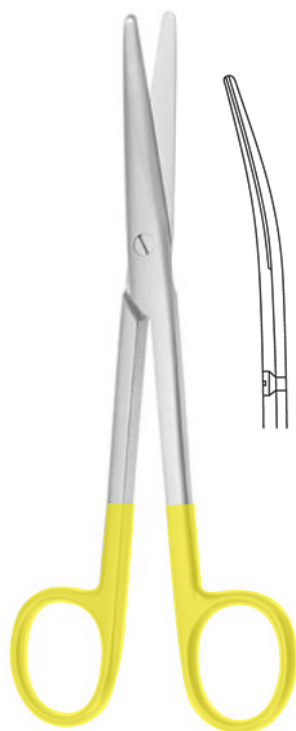

MAYO-STILLE
AS-02-398 15.0 cm, 6"
AS-02-399 17.0 cm, 6
 3/4"



LEXER
AS-02-400 16.0 cm, 6
 1/4" **AS-02-401** 21.0 cm,
 8 1/4"



LEXER
AS-02-402 16.0 cm, 6
 1/4" **AS-02-403** 21.0 cm,
 8 1/4"

DISSECTING SCISSORS WITH TUNGSTEN CARBIDE EDGES



ASAMAR
SURGICAL

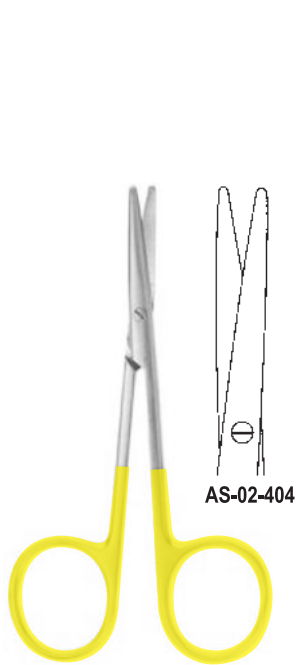

AS-02-404

AS-02-405

BABY-METZENBAUM
AS-02-404 - AS-02-405
11.5 cm, 4½"



AS-02-406

AS-02-407

METZENBAUM
AS-02-406 - AS-02-407
14.5 cm, 5 ¾"



AS-02-408

AS-02-409

METZENBAUM AS-
02-408 - AS-02-409
14.5 cm, 5 ¾"



AS-02-410

AS-02-411

METZENBAUM AS-02-
410 - AS-02-411 14.5
cm, 5 ¾"

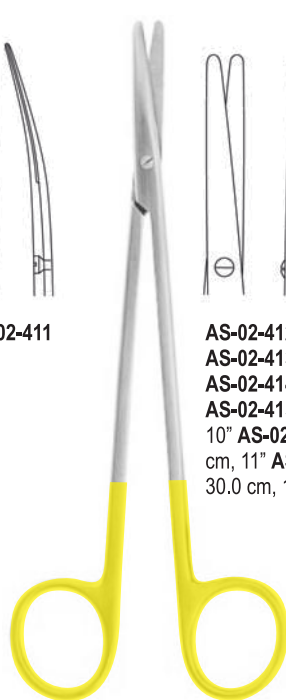

AS-02-412 18.0 cm, 7"
AS-02-413 20.0 cm, 8"
AS-02-414 23.0 cm, 9"
AS-02-415 25.0 cm,
10" AS-02-416 28.0
cm, 11" AS-02-417
30.0 cm, 12"

METZENBAUM
AS-02-412 - AS-02-417



AS-02-418 18.0 cm, 7"
AS-02-419 20.0 cm, 8"
AS-02-420 23.0 cm, 9"
AS-02-421 25.0 cm,
10" AS-02-422 28.0
cm, 11" AS-02-423
30.0 cm, 12"

METZENBAUM
AS-02-418 - AS-02-423

DISSECTING SCISSORS WITH TUNGSTEN CARBIDE EDGES

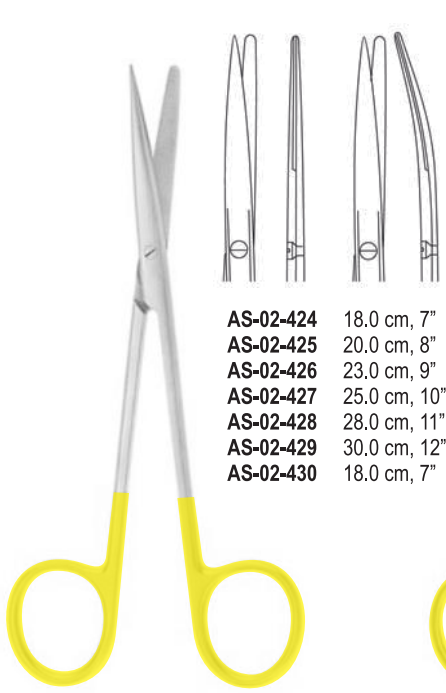

- AS-02-424** 18.0 cm, 7"
- AS-02-425** 20.0 cm, 8"
- AS-02-426** 23.0 cm, 9"
- AS-02-427** 25.0 cm, 10"
- AS-02-428** 28.0 cm, 11"
- AS-02-429** 30.0 cm, 12"
- AS-02-430** 18.0 cm, 7"

METZENBAUM
AS-02-424 - AS-02-429

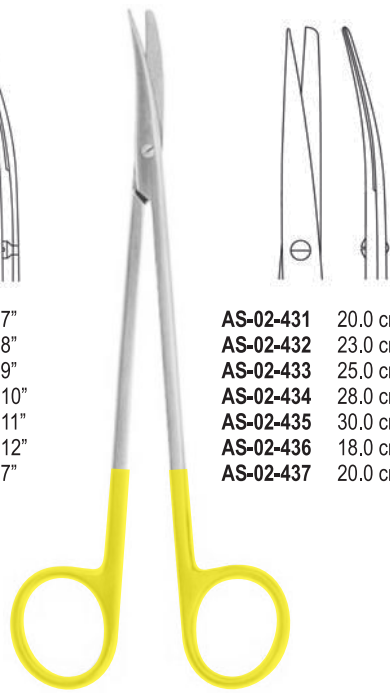

- AS-02-431** 20.0 cm, 8"
- AS-02-432** 23.0 cm, 9"
- AS-02-433** 25.0 cm, 10"
- AS-02-434** 28.0 cm, 11"
- AS-02-435** 30.0 cm, 12"
- AS-02-436** 18.0 cm, 7"
- AS-02-437** 20.0 cm, 8"

METZENBAUM
AS-02-430 - AS-02-435

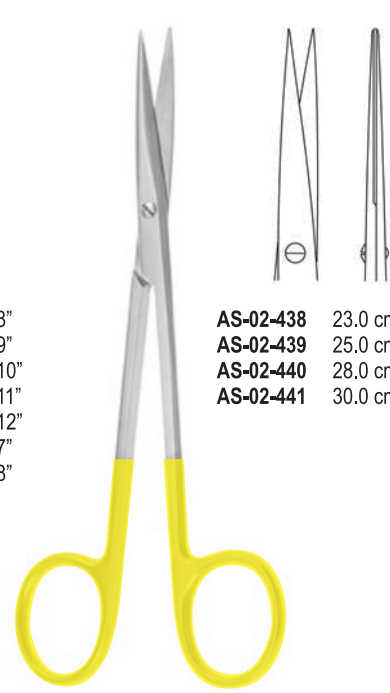

- AS-02-438** 23.0 cm, 9"
- AS-02-439** 25.0 cm, 10"
- AS-02-440** 28.0 cm, 11"
- AS-02-441** 30.0 cm, 12"

METZENBAUM
AS-02-436 - AS-02-441

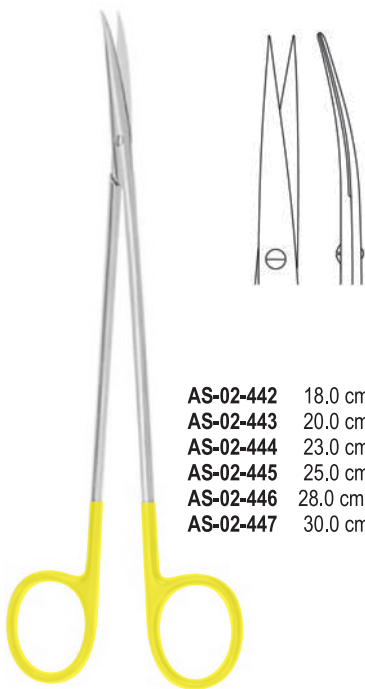

- AS-02-442** 18.0 cm, 7"
- AS-02-443** 20.0 cm, 8"
- AS-02-444** 23.0 cm, 9"
- AS-02-445** 25.0 cm, 10"
- AS-02-446** 28.0 cm, 11"
- AS-02-447** 30.0 cm, 12"

METZENBAUM
AS-02-442 - AS-02-447

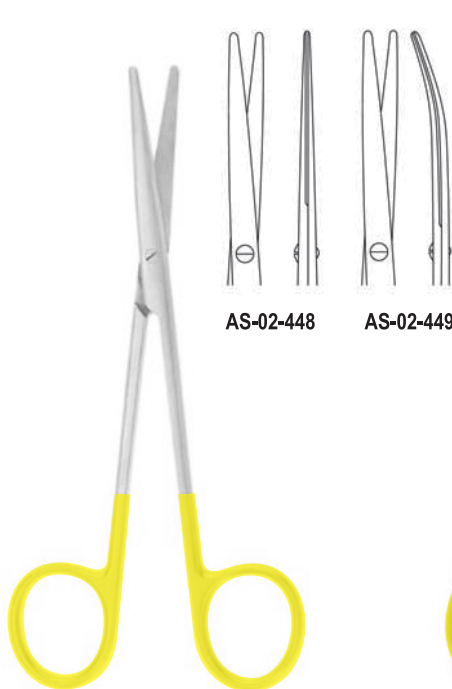

- AS-02-448**
- AS-02-449**

METZENBAUM-FINO
AS-02-448 - AS-02-449
14.5 cm, 5 3/4"

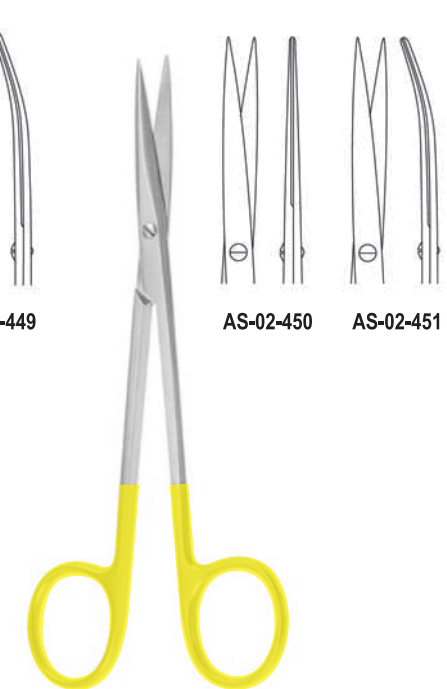

- AS-02-450**
- AS-02-451**

METZENBAUM-FINO
AS-02-450 - AS-02-451
14.5 cm, 5 3/4"

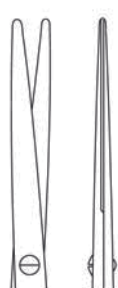
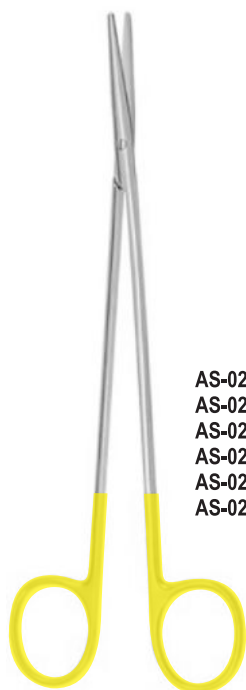

- AS-02-452 18.0 cm, 7"
- AS-02-453 20.0 cm, 8"
- AS-02-454 23.0 cm, 9"
- AS-02-455 25.0 cm, 10"
- AS-02-456 28.0 cm, 11"
- AS-02-457 30.0 cm, 12"

METZENBAUM-FINO
AS-02-452 - AS-02-457

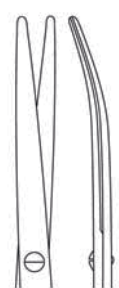
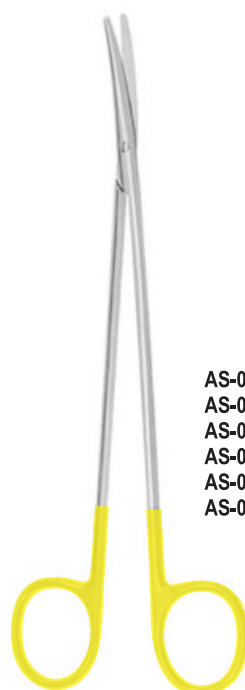

- AS-02-458 18.0 cm, 7"
- AS-02-49 20.0 cm, 8"
- AS-02-460 23.0 cm, 9"
- AS-02-461 25.0 cm, 10"
- AS-02-462 28.0 cm, 11"
- AS-02-463 30.0 cm, 12"

METZENBAUM-FINO
AS-02-458 - AS-02-463

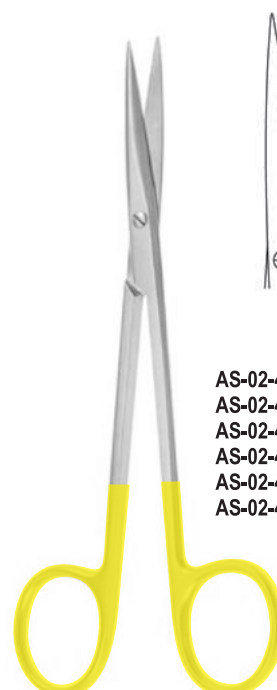

- AS-02-464 18.0 cm, 7"
- AS-02-465 20.0 cm, 8"
- AS-02-466 23.0 cm, 9"
- AS-02-467 25.0 cm, 10"
- AS-02-468 28.0 cm, 11"
- AS-02-469 30.0 cm, 12"

METZENBAUM-FINO
AS-02-464 - AS-02-469

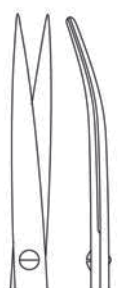
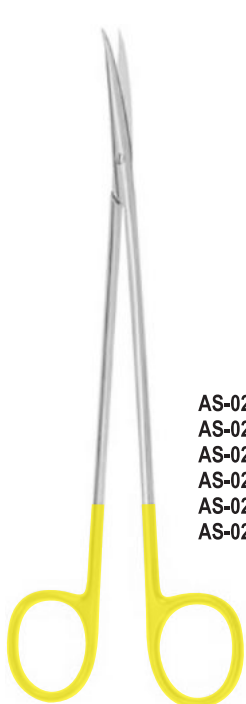

- AS-02-470 18.0 cm, 7"
- AS-02-471 20.0 cm, 8"
- AS-02-472 23.0 cm, 9"
- AS-02-473 25.0 cm, 10"
- AS-02-474 28.0 cm, 11"
- AS-02-475 30.0 cm, 12"

METZENBAUM-FINO
AS-02-470 - AS-02-475



METZENBAUM-LAHEY
AS-02-476
14.5 cm, 5½"

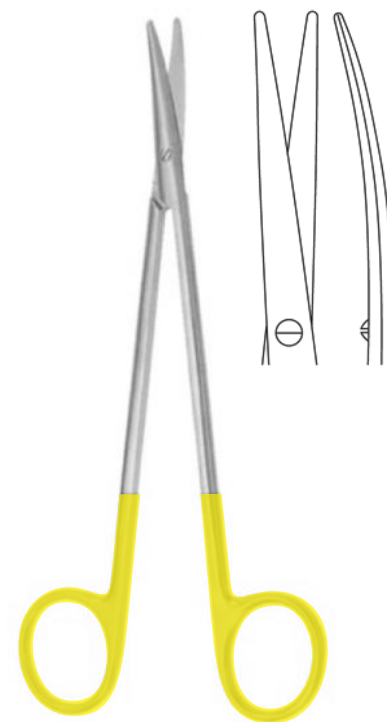

TOENNIS-ADSON
AS-02-477
17.0 cm, 6 ¾"

DISSECTING SCISSORS WITH TUNGSTEN CARBIDE EDGES



ASAMAR
SURGICAL

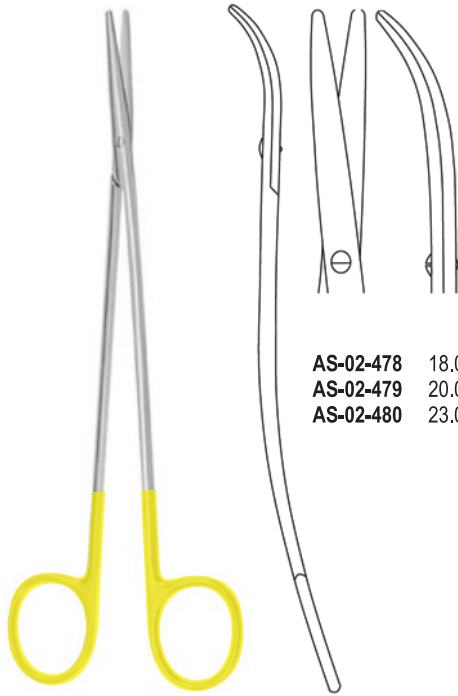

AS-02-478 18.0 cm, 7"
AS-02-479 20.0 cm, 8"
AS-02-480 23.0 cm, 9"

METZENBAUM-FINO
AS-02-478 - AS-02-480

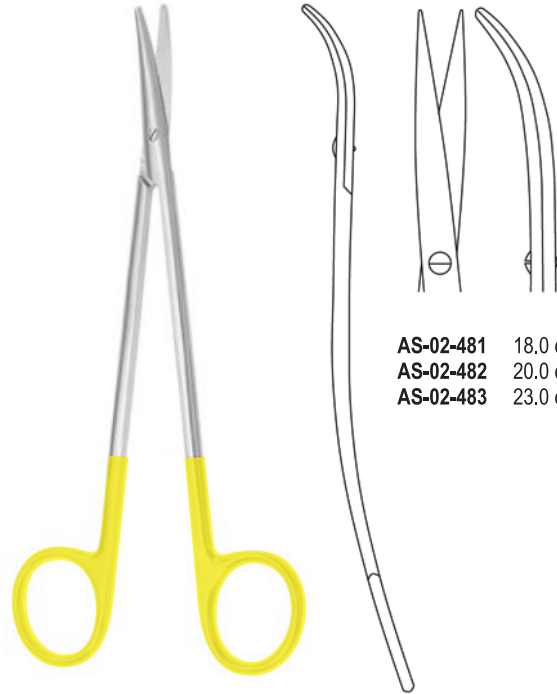

AS-02-481 18.0 cm, 7"
AS-02-482 20.0 cm, 8"
AS-02-483 23.0 cm, 9"

METZENBAUM-FINO
AS-02-481 - AS-02-483

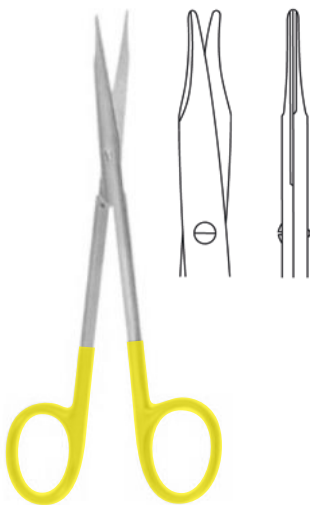

REYNOLDS
AS-02-484
15.0 cm, 6"

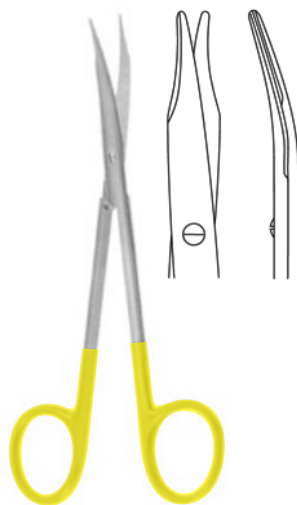

REYNOLDS
AS-02-485
15.0 cm, 6"



HYSTEREKTOMY
AS-02-486
25.5 cm, 10"



HYSTEREKTOMY
AS-02-487
25.5 cm, 9 3/4"



SIMS
AS-02-488 - AS-02-489

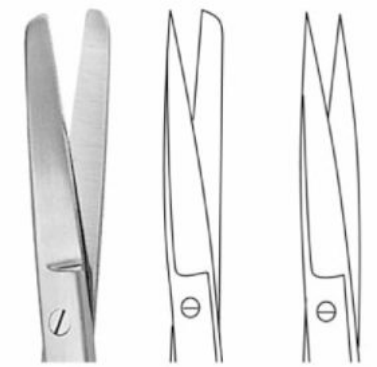

AS-02-488 20,0 cm, 8"
AS-02-489 23,0 cm, 9"



SIMS
AS-02-490 - AS-02-491



AS-02-490 20,0 cm, 8"
AS-02-491 23,0 cm, 9"

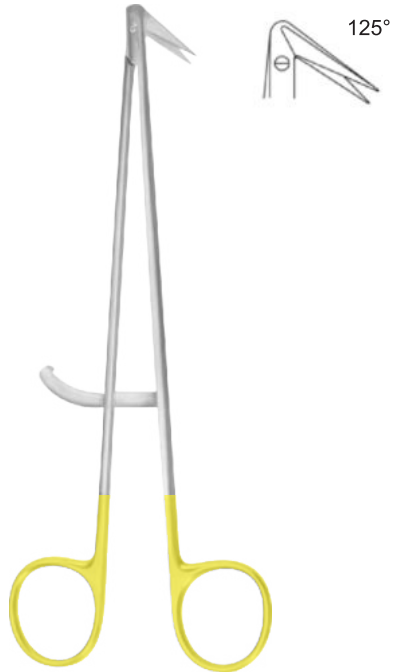

DIETHRICH
AS-02-492
17.5 cm, 6
5/8"

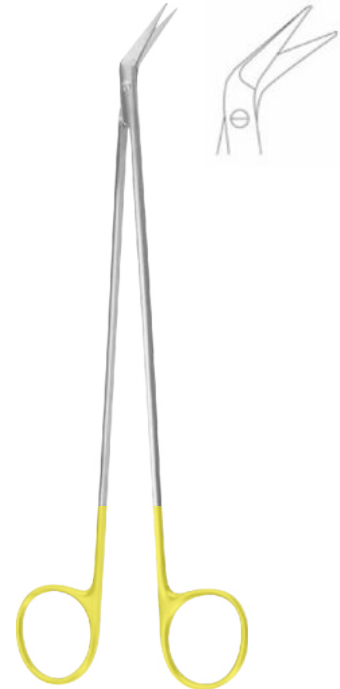

POTTS DE MARTEL
AS-02-493
24.0 cm, 9 1/2"



DE BAKEY
AS-02-494 - AS-02-495

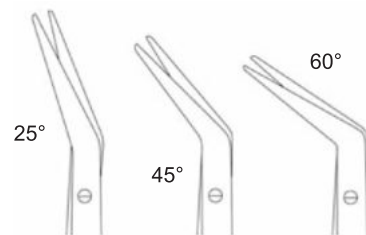

AS-02-494 20.0 cm, 8"
AS-02-495 23.0 cm, 9"

VASCULAR SCISSORS WITH TUNGSTEN CARBIDE EDGES



ASAMAR
SURGICAL

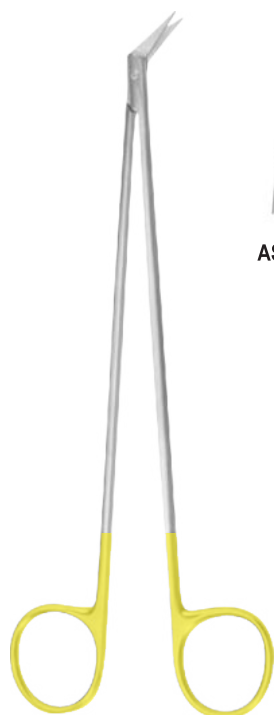

AS-02-496

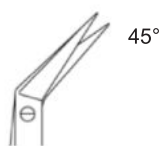

AS-02-497

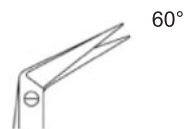

AS-02-498

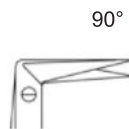

AS-02-499



AS-02-500

DIETRICH-HEGEMANN
AS-02-496 - AS-02-500
18.0 cm, 7"

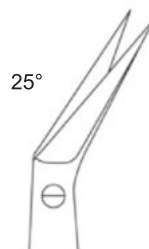

AS-02-501

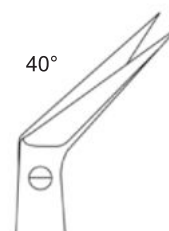

AS-02-502

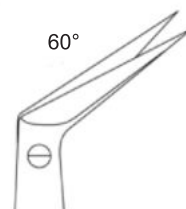

AS-02-503

POTTS-SMITH AS-02-
501 - AS-02-503 18.0
cm, 7½"

SCISSORS WITH TUNGSTEN CARBIDE EDGES

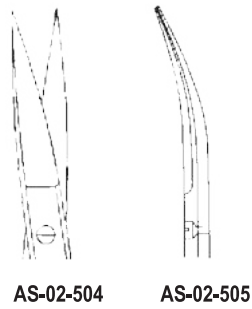
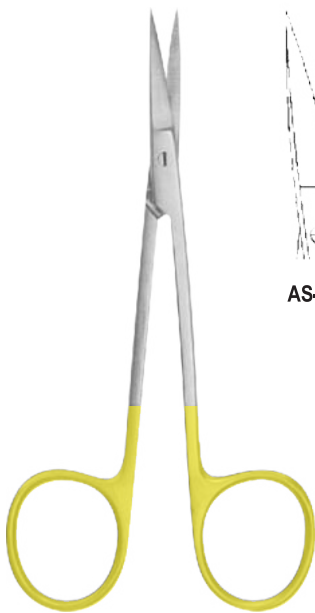

AS-02-504

AS-02-505

IRIS
AS-02-504 - AS-02-505
11.5 cm, 4½"

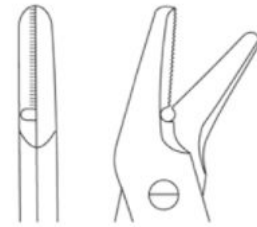
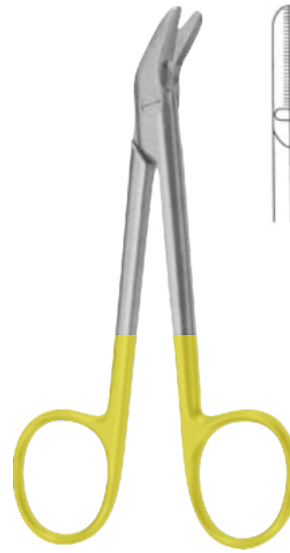

gezahnt
serrated
dentada
dentata

UNIVERSAL
AS-02-506
12.0 cm, 4
¾"

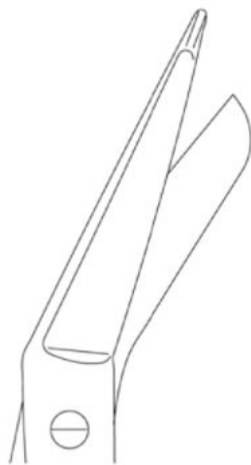
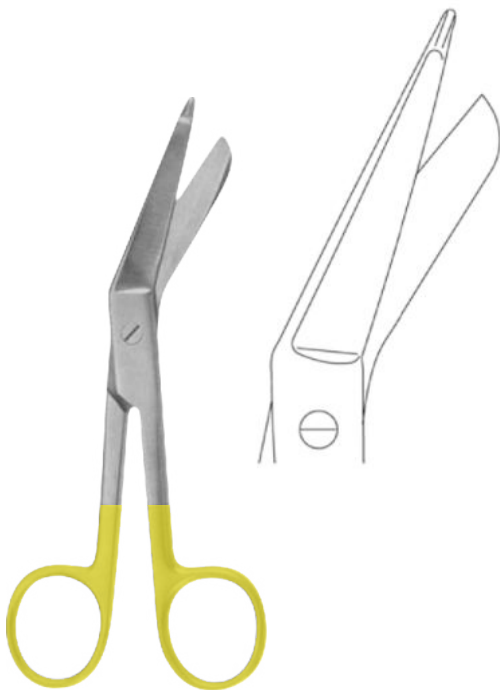

LISTER
AS-02-507
18.0 cm, 7"

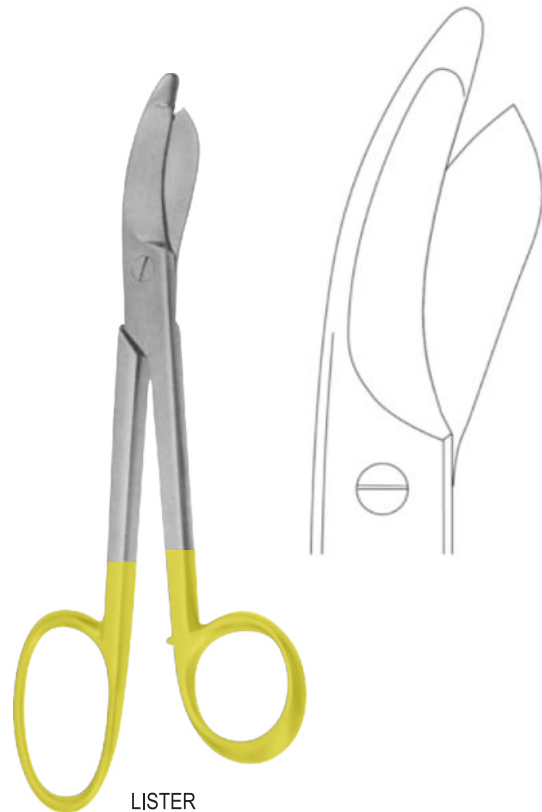

LISTER
AS-408
24.0 cm, 9½"

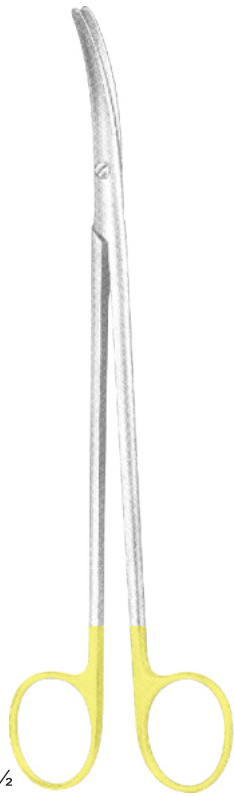

1/2

**METZENBAUM-THOREK
AS-02-509 - AS-02-511**

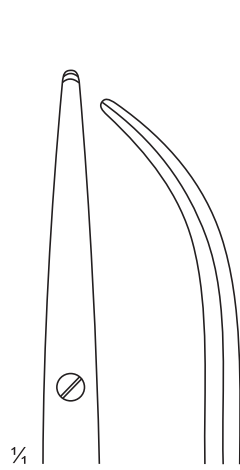

1/4

**AS-02-509
200 mm**

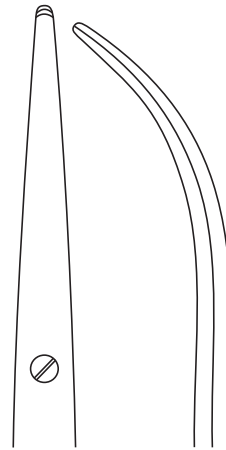

1/4

**AS-02-510
230 mm**

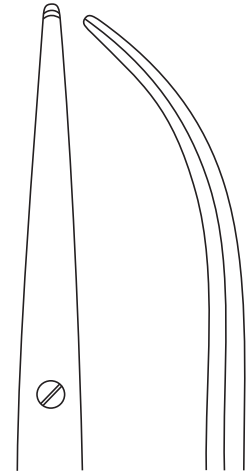

1/4

**AS-02-511
280 mm**

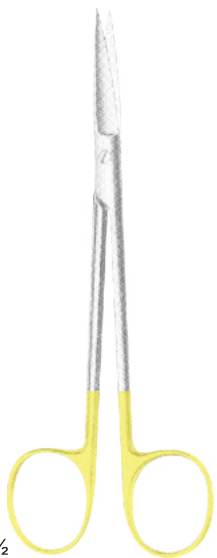

1/2

**JOSEPH
AS-02-512 - AS-02-513**

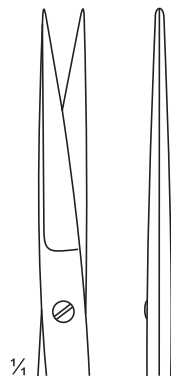

1/4

**AS-02-512
14.5 cm**



1/4

**AS-02-513
14.5 cm**

**DELICATE DISSECTING SCISSORS
WITH TUNGSTEN CARBIDE**

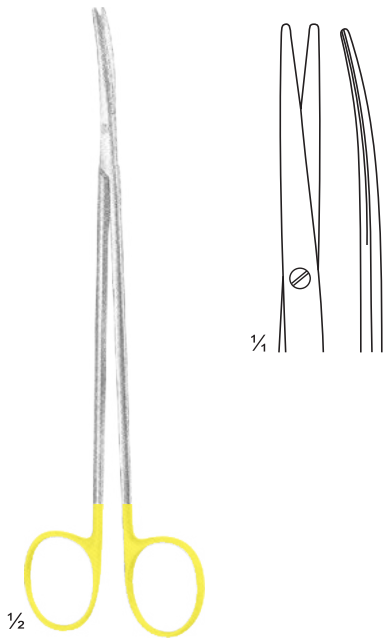

TOENNIS-ADSON
AS-02-514
175 mm
slender pattern



METZENBAUM-FINO
AS-02-515 - AS-02-516
slender pattern



AS-02-515
205 mm

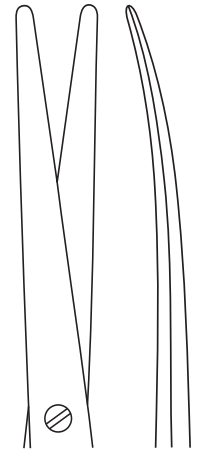

AS-02-516
230 mm

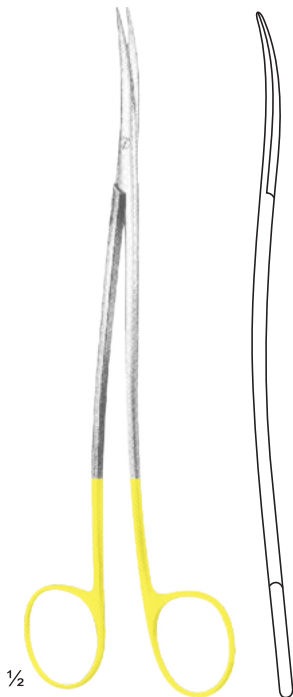

METZENBAUM-FINO
AS-02-517 - AS-02-519
slender pattern



AS-02-517
180 mm



AS-02-518
205 mm



AS-02-519
230 mm

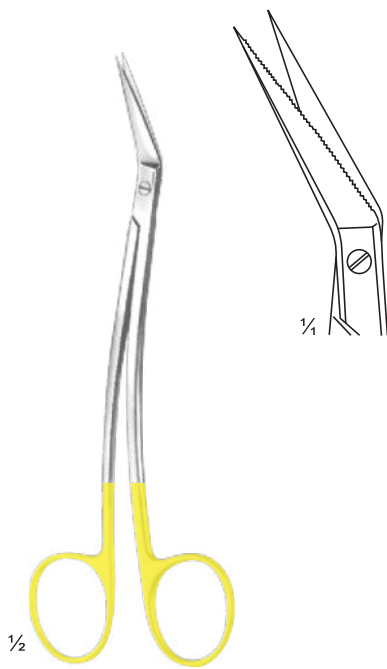

LOCKLIN AS-02-520
160 mm
one toothed cutting edge

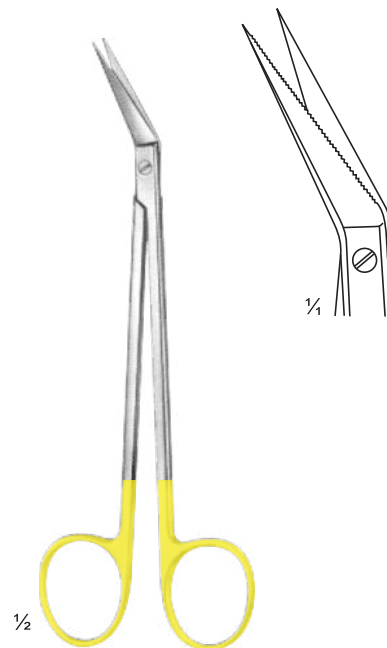

LOCKLIN AS-02-521
160 mm
one toothed cutting edge

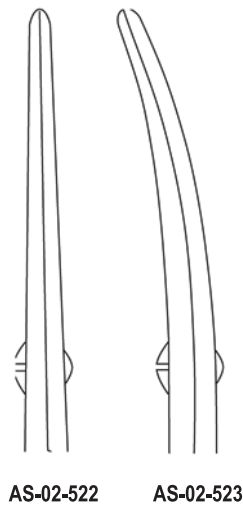

AS-02-522 AS-02-523

MAYO
AS-02-522 - AS-02-523
17.0 cm, 6 3/4"

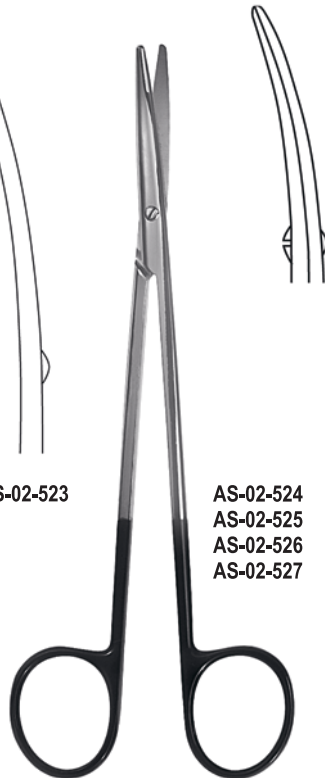

AS-02-524 14.5 cm, 5 3/4"
AS-02-525 18.0 cm, 7"
AS-02-526 20.0 cm, 8"
AS-02-527 23.0 cm, 9"

METZENBAUM
AS-02-524 - AS-02-527

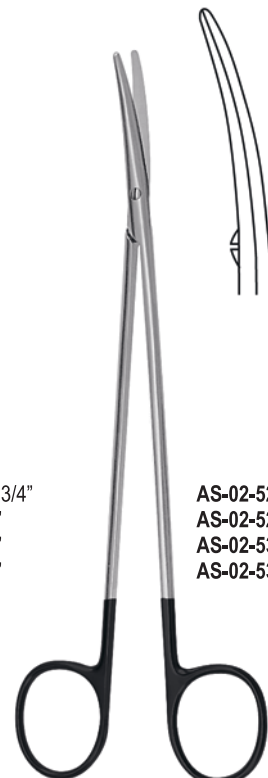

AS-02-528 14.5 cm, 5 3/4"
AS-02-529 18.0 cm, 7"
AS-02-530 20.0 cm, 8"
AS-02-531 23.0 cm, 9"

METZENBAUM-FINO
AS-02-528 - AS-02-531

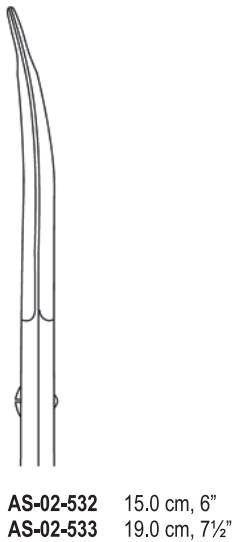

AS-02-532 15.0 cm, 6"
AS-02-533 19.0 cm, 7 1/2"

KAYE FACE LIFT
AS-02-532 - AS-02-533



JABLEY
AS-02-534
13.0 cm, 5"



ENDARTERECTOMY
AS-02-535
18.0 cm, 7"



TOENNIS-ADSON
AS-02-536
17.0 cm, 6 3/4"



STRABISMUS
AS-02-537 - AS-02-538
11.5 cm, 4 1/2"

JAMISON
AS-02-539 15.0 cm, 6"
AS-02-540 18.0 cm, 7"

REYNOLDS
AS-02-541
12.5 cm, 5"

BABY-METZENBAUM
AS-02-542 11.0 cm, 4 3/8"
AS-02-543 14.5 cm, 5 3/4"



IRIS
AS-02-544
11.0 cm, 4 3/8"

IRIS
AS-02-545
11.0 cm, 4 3/8"

STEVENS TENOTOMY
AS-02-546
11.0 cm, 4 3/8"

STEVENS TENOTOMY
AS-02-547
11.0 cm, 4 3/8"



PAR TYPE
AS-02-548
12.0 cm, 4
3/4"



PAR TYPE
AS-02-549
12.0 cm, 4
3/4"



POTTS
AS-02-550 - AS-02-552
19.0 cm, 7 1/2"

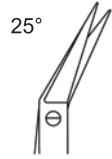

AS-02-550

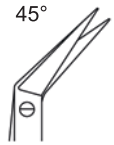

AS-02-551

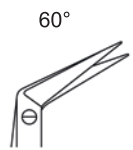

AS-02-552

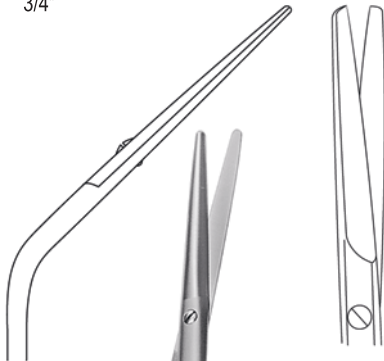

AS-02-553
14.5 cm, 5 3/4"

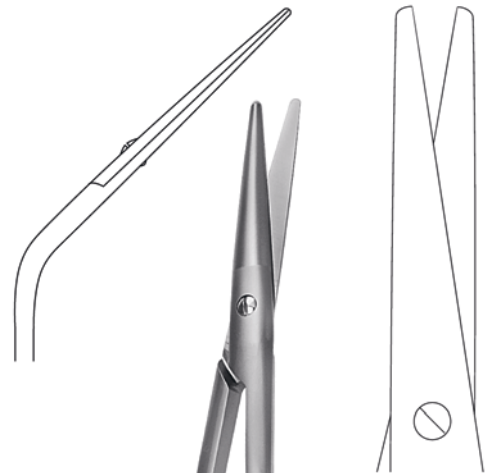

COTTLE
AS-02-554
16.5 cm, 6 1/2"



AS-02-555
14.5 cm



AS-02-556
18 cm

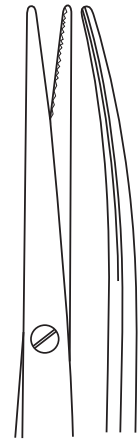

AS-02-557
20.5 cm



1/2



AS-02-558
23 cm



AS-02-559
25 cm



AS-02-560
30 cm

LIGATURE SCISSORS
AS-02-555 - AS-02-560
for synthetic suture
material, one toothed
cutting edge



1/2



1/4

AS-02-561
14.5 cm



AS-02-562
17 cm



AS-02-563
23 cm

LIGATURE SCISSORS
AS-02-561 - AS-02-563
for synthetic suture
material, one toothed
cutting edge



1/2



1/4

IRIS
AS-02-564
11.5 cm

DISSECTING SCISSORS
(WITH TUNGSTEN CARBIDE AND SUPER-CUT EDGES)



ASAMAR
SURGICAL

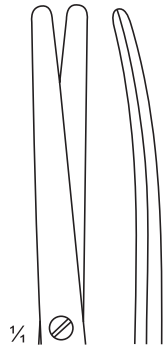

AS-02-565
18 cm

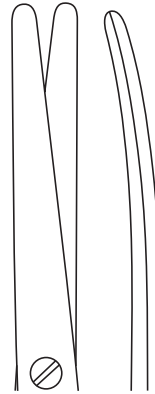

AS-02-566
20 cm



AS-02-567
23 cm

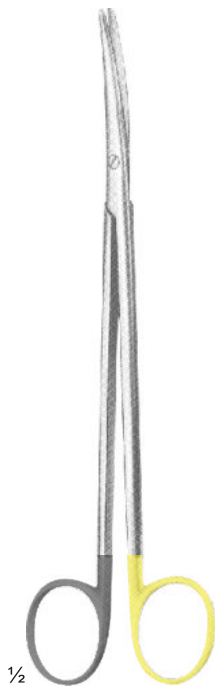

1/2

METZENBAUM
AS-02-565 - AS-02-570



AS-02-568
26 cm



AS-02-569
28.5 cm

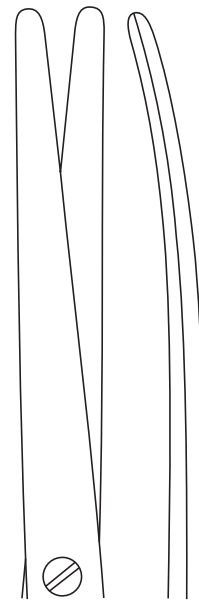

AS-02-570
31 cm



ASAMAR
SURGICAL 

PAGE

71-77

PROBES
COTTON APPLICATORS
SUTURE CLIPS
CLIP APPLYING FORCEPS
CLIP REMOVING FORCEPS

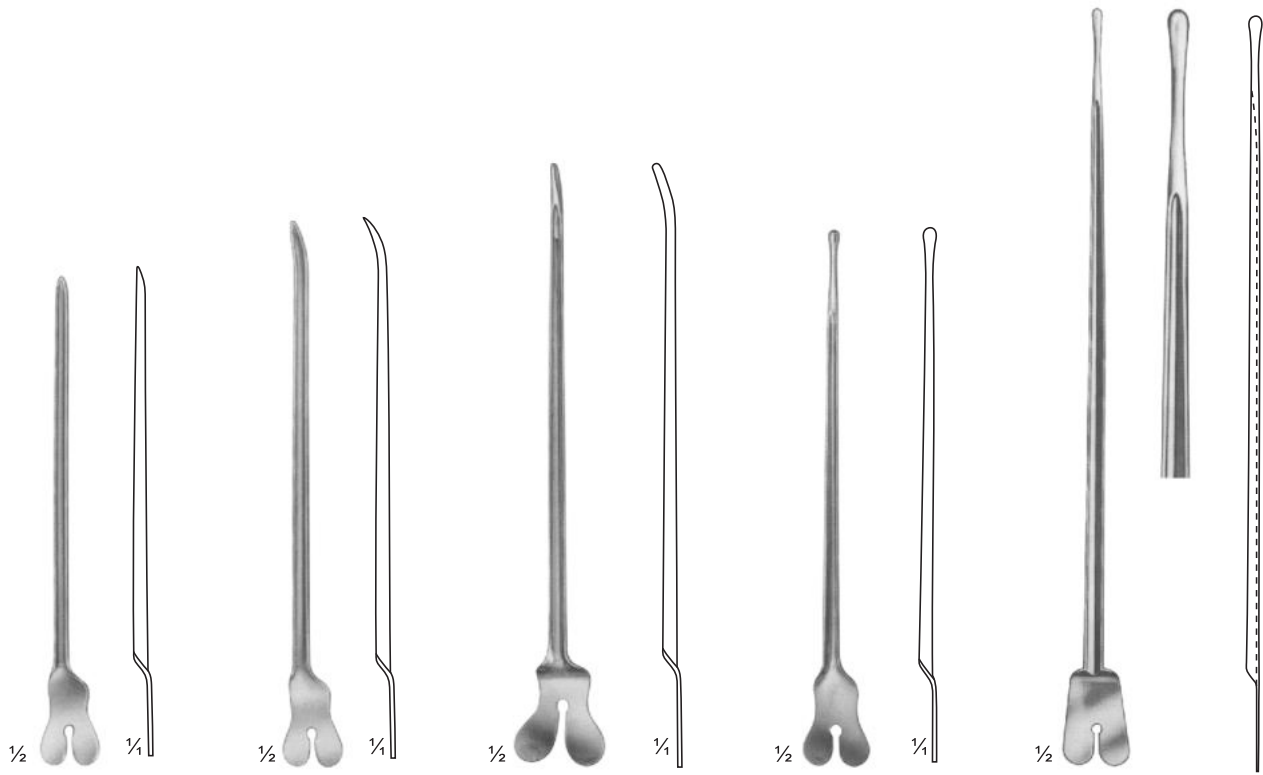

AS-03-101 130 mm
AS-03-102 145 mm
AS-03-103 160 mm
 Directors

AS-03-104
 DOYEN
 145 mm
 Directors

AS-03-105
 NELATON
 160 mm
 Directors

AS-03-106
 Director with tip
 Diam. Of tip 3,3
 mm 140 mm

AS-03-107
 BRODIE
 Director with tip, Diam.
 Of tip 3,5 mm 200 mm



AS-03-108 2,5 mm
AS-03-109 2,5 mm
AS-03-110 3,0 mm

AS-03-108 145 mm
AS-03-109 160 mm
AS-03-110 200 mm
 Probes with eye



1.5 mm

AS-03-111
 Myrtle leaf
 probe 145 mm



2 mm

AS-03-112 130 mm
AS-03-113 145 mm
AS-03-114 160 mm
AS-03-115 180 mm
AS-03-116 200 mm



AS-03-117
 Probes



AS-03-118
 Double ended probe,
 malleable, diam. of
 tips 3 mm with hole
 190 mm



AS-03-119
 Double ended probes,
 tin, malleable,
 diam. of tips
 3,5 mm with hole
 250 mm, 300 mm



AS-03-120
 Double ended probes,
 tin, malleable,
 diam. of tips 4 mm
 400 mm



AS-03-121 1,5 mm
AS-03-122 2,0 mm
AS-03-123 2,5 mm
 300 mm

PROBES - SPATULAS - COTTON APPLICATORS



ASAMAR
SURGICAL



AS-03-124
STACKE
100 mm

AS-03-125
KILLIAN
165 mm

AS-03-126
160 mm

AS-03-127
SEIFFERT
180 mm

AS-03-128
BOWMAN
130 mm

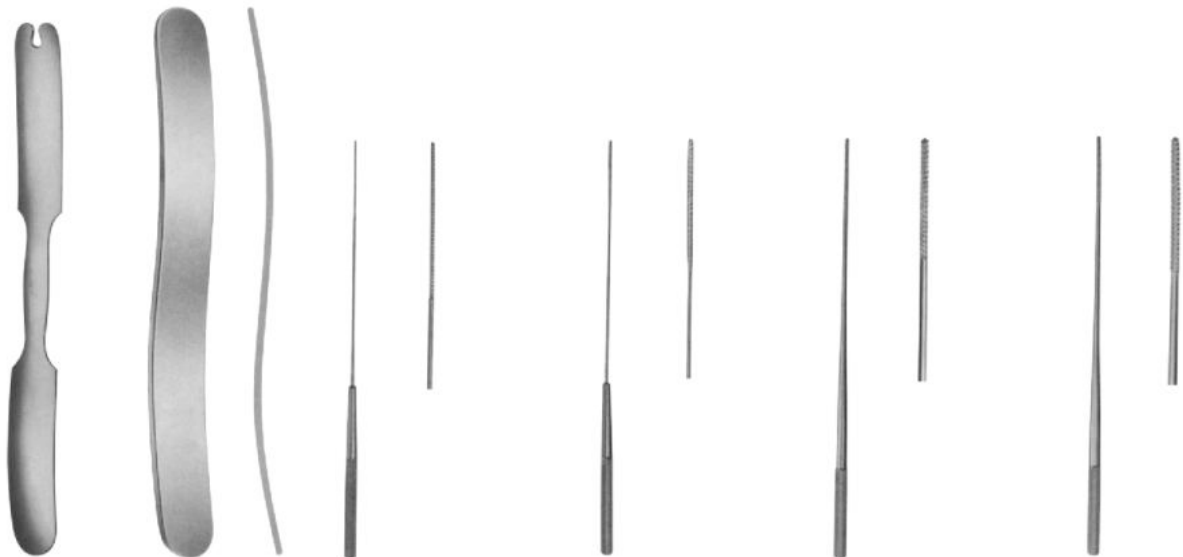

AS-03-129
SPATULA
145 mm

AS-03-130
SPATULA
145 mm

AS-03-131
Modell PICCOLO
Round Serrated
110 mm

AS-03-132
Modell PICCOLO
Triangular Serrated end
110 mm

AS-03-133
FARRELL
Round Serrated end
110 mm

AS-03-134 LATHBURY-
FARRELL Triangular
Serrated end 110 mm

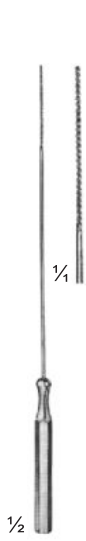

AS-03-135 BUCK
Rough, spiral end
120 mm

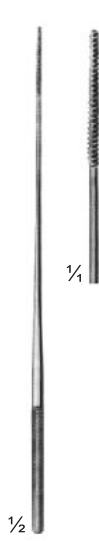

AS-03-136
Triangular
serrated
end 140 mm

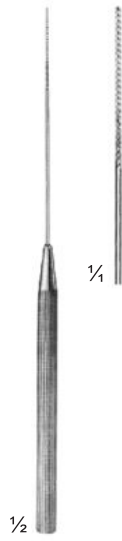

AS-03-137
Rough, spiral
end 140 mm



AS-03-138
Rough, spiral
end 140 mm



AS-03-139
Rough, spiral
end 140 mm



AS-03-140 FARRELL
Round,
serrated end
140 mm



AS-03-141 LATHBURY-FARRELL
Triangular,
serrated end
140 mm



AS-03-142 FARRELL
Rough,
spiral end
160 mm



AS-03-143 LATHBURY-FARRELL
Triangular,
serrated end
160 mm



AS-03-144
Triangular,
serrated end
160 mm



AS-03-145
Rough,
spiral end
180 mm



AS-03-146
Rough,
spiral end
180 mm



AS-03-147
Rough,
spiral end
270 mm



1/2

AS-03-148
MICHEL
125 mm



1/2

AS-03-149
HEGENBARTH
120 mm



1/2

AS-03-150
WACHENFELDT
120 mm



1/2

AS-03-151
WACHENFELDT
120 mm



1/2

AS-03-152
MICHEL
125 mm



1/2

AS-03-153
MICHEL
modif.
130 mm



1/2

AS-03-154
HEATH
135 mm



1/2

AS-03-155
COLLIN
135 mm



- AS-03-156 8 CH
- AS-03-157 10 CH
- AS-03-158 12 CH
- AS-03-159 14 CH
- AS-03-160 16 CH
- AS-03-161 18 CH

REDON
AS-03-156 - AS-03-161
threaded end
19.5 cm



- AS-03-162 8 CH
- AS-03-163 10 CH
- AS-03-164 12 CH
- AS-03-165 14 CH
- AS-03-166 16 CH
- AS-03-167 18 CH
- AS-03-168 8 CH

REDON
AS-03-162 - AS-03-167
threaded end
14 cm



- AS-03-169 10 CH
- AS-03-170 12 CH
- AS-03-171 14 CH
- AS-03-172 16 CH
- AS-03-173 18 CH
- AS-03-174 8 CH
- AS-03-175 10 CH

REDON
AS-03-168 - AS-03-173
threaded end
19.5 cm



- AS-03-176 12 CH
- AS-03-177 14 CH
- AS-03-178 16 CH
- AS-03-179 18 CH

REDON
AS-03-174 - AS-03-179
threaded end
19.5 cm



NABATOFF
AS-03-180
135x100x25 mm



AS-03-181



AS-03-182
Ø 3 mm



AS-03-183
Ø 6 mm



AS-03-187



AS-03-184
Ø 9 mm



AS-03-185
Ø 12 mm



AS-03-186
Ø 15 mm

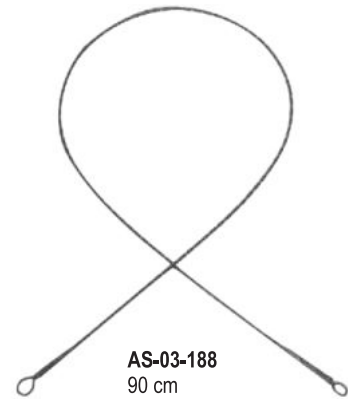

AS-03-188
90 cm



MYERS
AS-03-189



AS-03-190
Ø 6 mm



AS-03-191
Ø 9 mm



AS-03-192
Ø 12 mm



AS-03-193
Ø 15 mm



VARADY
AS-03-194



AS-03-195



AS-03-196



AS-03-197

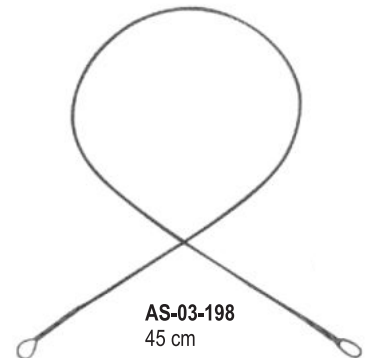

AS-03-198
45 cm



ASAMAR
SURGICAL 

PAGE

78-102

**SELF-RETAINING RETRACTORS
ABDOMINAL RETRACTORS**



AS-04-101
WEITLANER
Sharp
110 mm

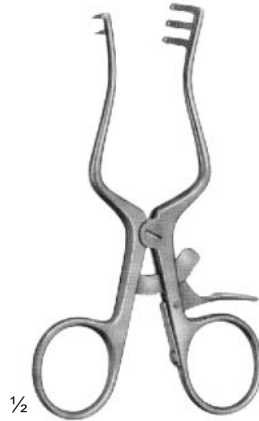

AS-04-102
WEITLANER
Semi-Sharp
110 mm



AS-04-103
WEITLANER
Blunt
110 mm



AS-04-104
WEITLANER
Sharp
130 mm



AS-04-105
WEITLANER
Semi-Sharp
130 mm

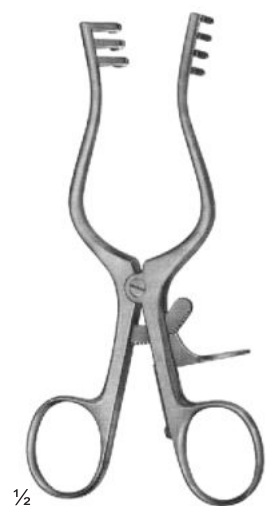

AS-04-106
WEITLANER
Blunt
130 mm

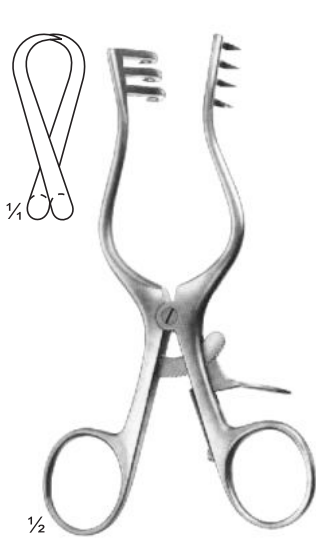

AS-04-107
WEITLANER
Sharp
130 mm

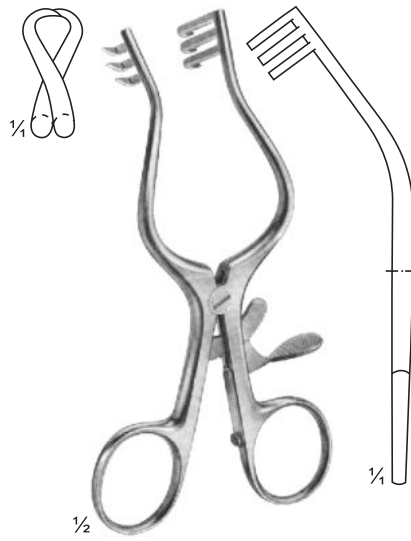

AS-04-108
WULLSTEIN
Sharp
130 mm

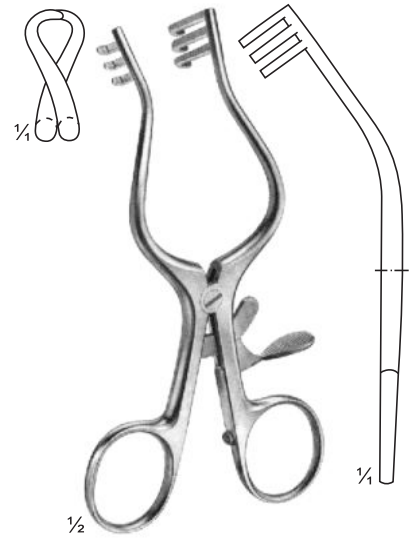

AS-04-109
WULLSTEIN
Blunt
130 mm



AS-04-110
WEITLANER
Sharp
165 mm

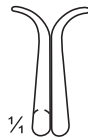

AS-04-111
PLESTER
Blunt
110 mm



AS-04-112
PERKINS
Blunt
130 mm



AS-04-113
ADSON-BABY
Blunt
140 mm

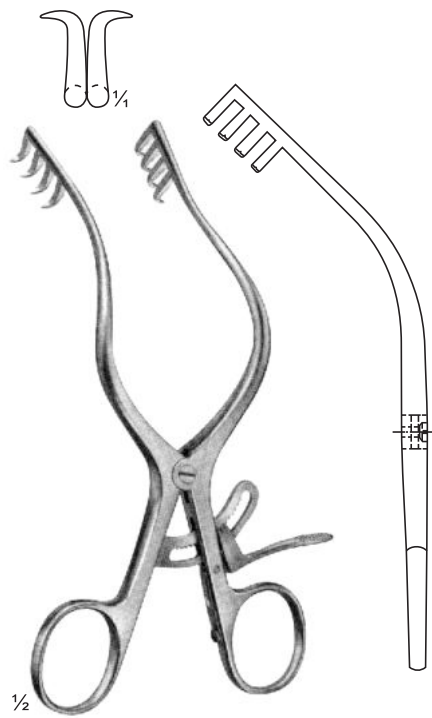

AS-04-114
MOLLISON
Sharp
155 mm



AS-04-115
MAYO-ADAMS
165 mm

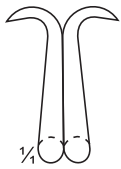

AS-04-116
ANDERSON-ADSON
Sharp
190 mm



AS-04-117
NORFOLK and
NORWICH
Blunt
220 mm



AS-04-118
ADSON Sharp
265 mm

SELF-RETAINING LAMINECTOMY RETRACTORS



ASAMAR
SURGICAL



Sharp

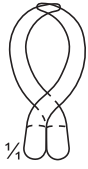

Semi-Sharp

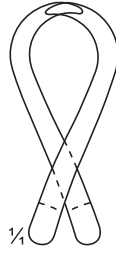

Semi-Sharp

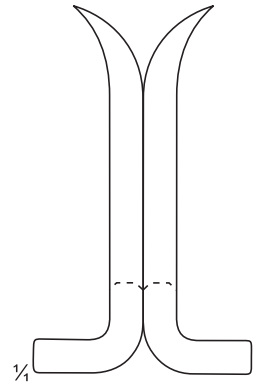

1/4



1/2
AS-04-119
BECKMANN-ADSON
Sharp
310 mm



AS-04-119A
BECKMANN-ADSON
Semi-Sharp
310 mm

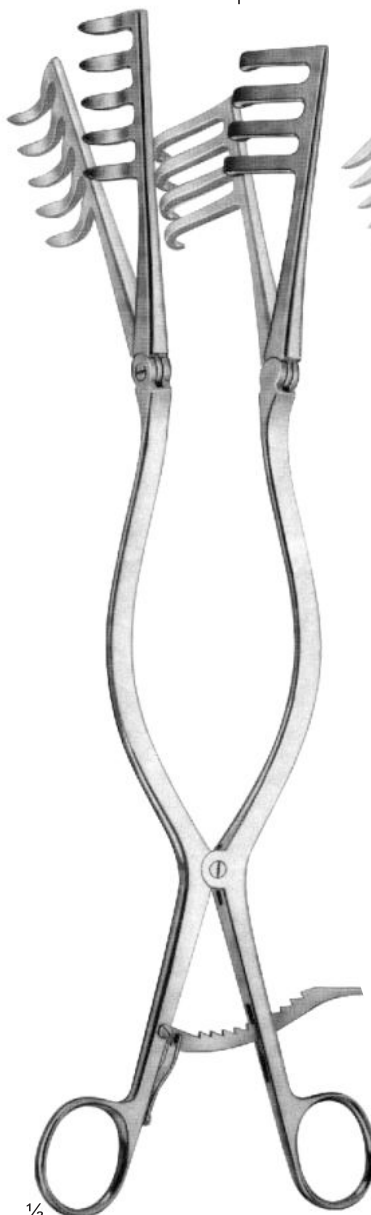

1/2
AS-04-120
ADSON
Semi-Sharp
320 mm



1/2
AS-04-121
BECKMANN-EATON
Sharp
320 mm

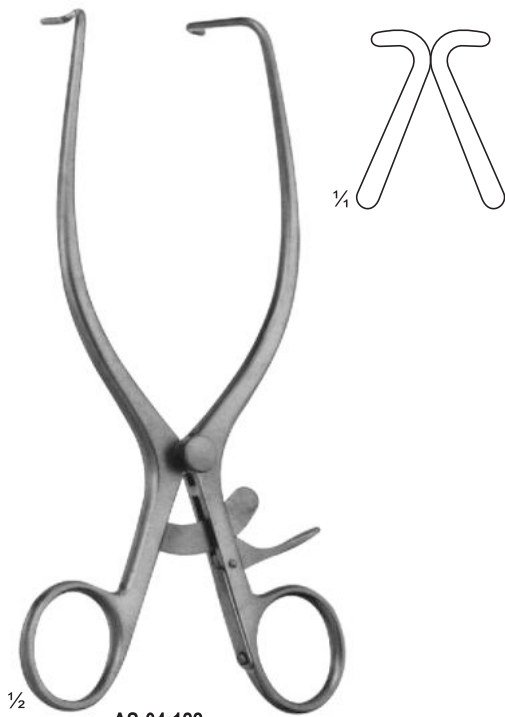

1/2
AS-04-122
 JACKSON BURROWS
 Retractor, blunt
 185 mm



1/2
AS-04-123
 GELPI
 Vaginal
 Retractor 135
 mm



1/2
AS-04-124 GELPI
 Skin- and Vaginal
 Retractor 175 mm



1/2
AS-04-125
 DE BAKEY
 Femur
 Retractor 145
 mm

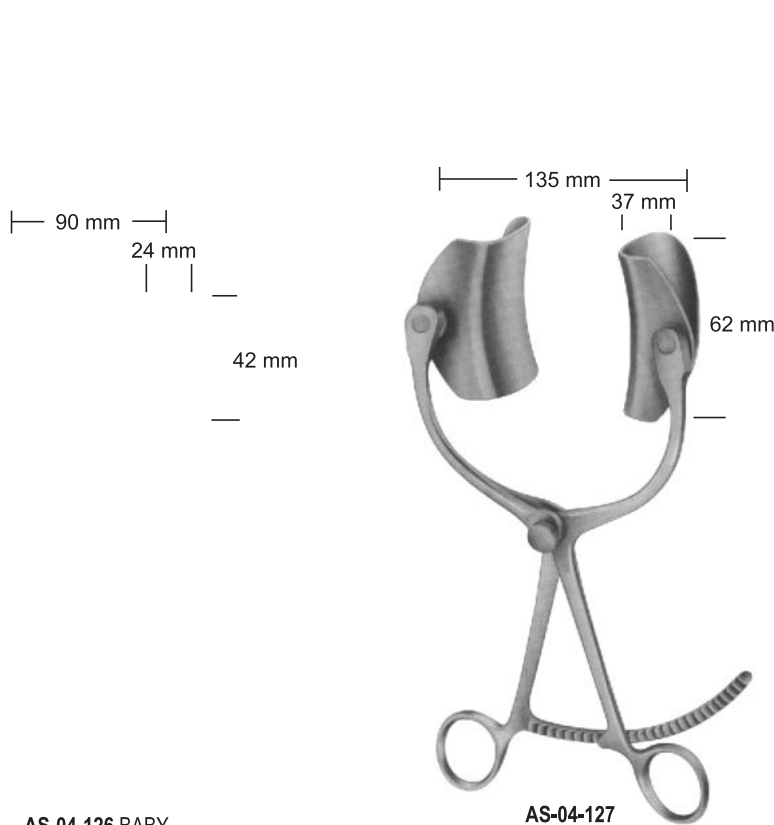

AS-04-126 BABY-COLLIN
with 2 pair of blades

AS-04-127 COLLIN complete

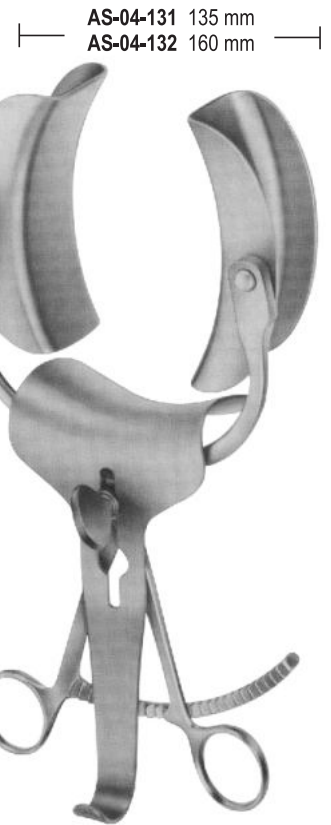

AS-04-128 - AS-04-132 COLLIN complete

AS-04-128 Spreader only 37x62mm
AS-04-129 Lateral blade 37x80mm
AS-04-130 Canter blade 54x55mm
AS-04-131 Spreader only 37x98mm
AS-04-132 Canter blade 54x76mm



AS-04-133 - AS-04-134 RICARD complete
Spreader only **AS-04-133** **AS-04-134**
Lateral blade 58x80mm 72x84mm
Canter blade 54x70mm 72x90mm



AS-04-135 - AS-04-137 HOLZBACH Complete
AS-04-135 Spreader only
AS-04-136 Lateral blade 59x80mm
AS-04-137 Canter blade 74x82mm

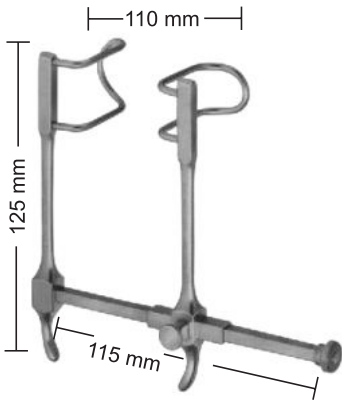

AS-04-138
GOSSET
Blades: 38 mm deep

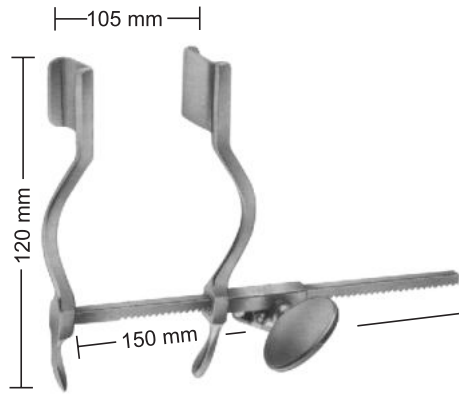

AS-04-139
HERTZLER
Blades 20 X 25 mm

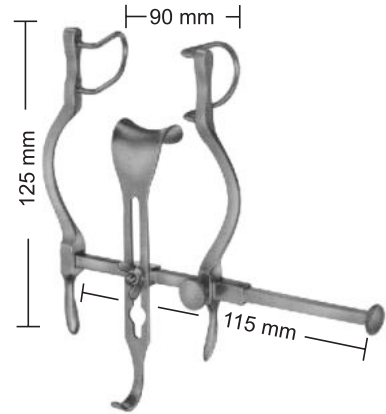

AS-04-140 BALFOUR-BABY
Lateral blades 27 mm deep
Center blade 21x24 mm

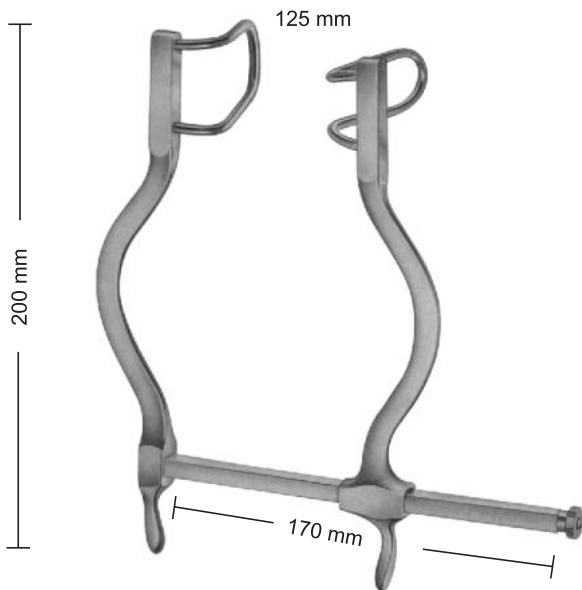

AS-04-141
GOSSET
Blades: 55 mm deep

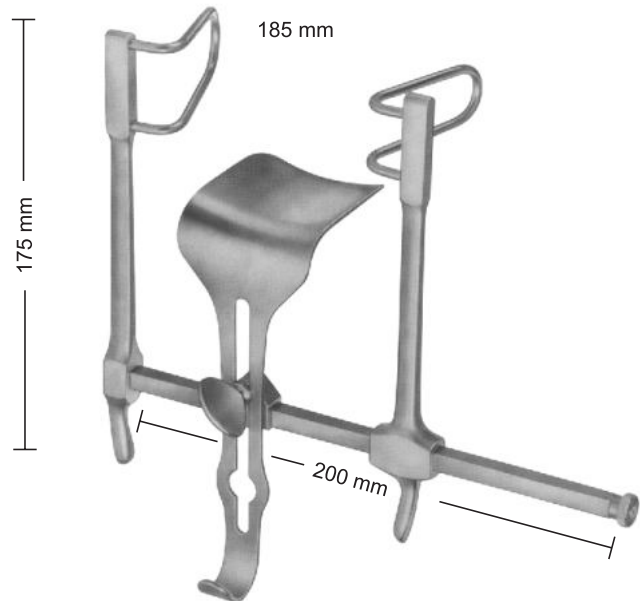

AS-04-142 GOSSET
Lateral blades 58 mm deep
Center blade 59 x 57 mm

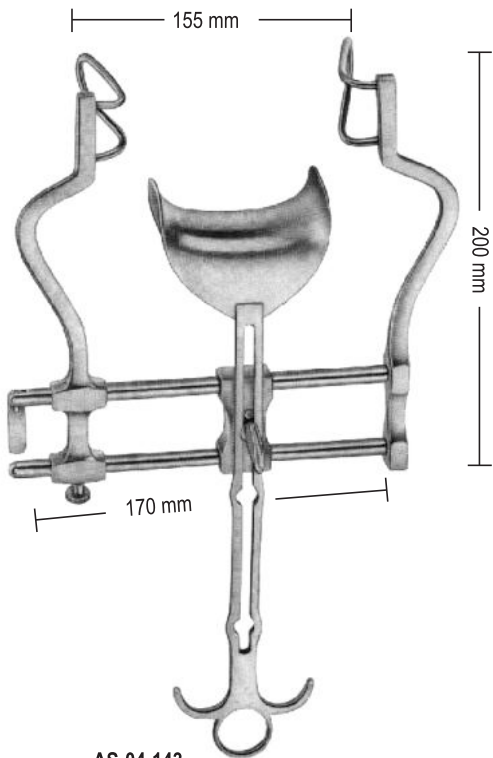

AS-04-143
BALFOUR
Lateral blades 60 mm deep
Center blade 47 x 80 mm

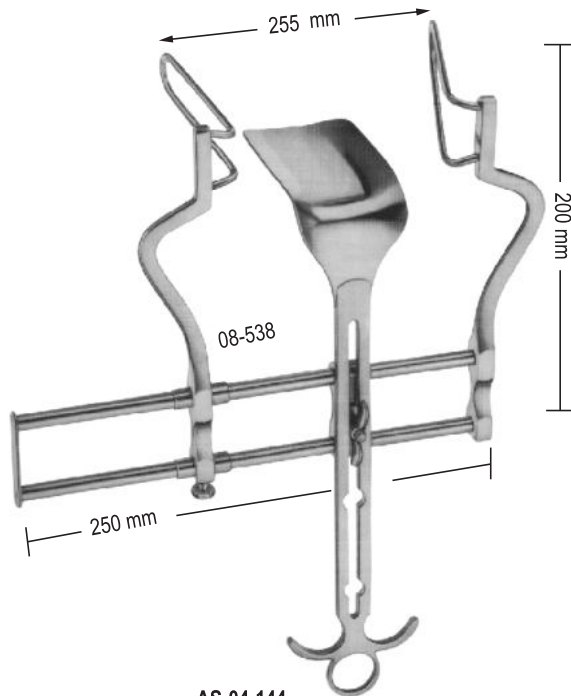

AS-04-144
BALFOUR
Lateral blades 105 mm deep
Center blade 107x 59 mm

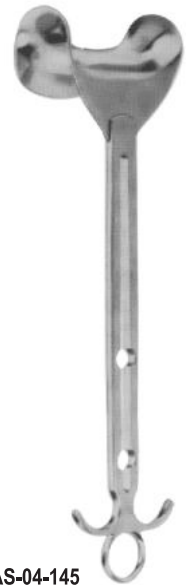

AS-04-145
Center blade
only 54x80 mm

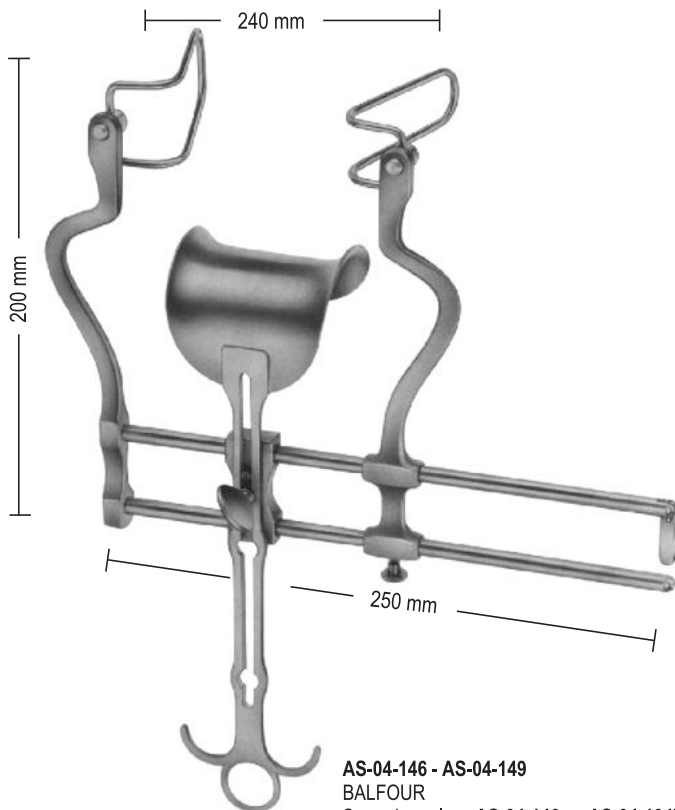

AS-04-146 - AS-04-149
BALFOUR

Spreader only	AS-04-146	AS-04-1047	AS-04-148	AS-04-149
Lateral blades	50 mm	60 mm	75 mm	90 mm
Center blade	47 x 80 mm	62x76 mm	80x80 mm	80x80 mm



Sales Unit of blades: PR = pair

Lateral blades
AS-04-150
50 mm deep
AS-04-151
60 mm deep
AS-04-152
75 mm deep
AS-04-153
90 mm deep

WOUND SPREADERS, SELF-RETAINING



ASAMAR
SURGICAL



BOSE AS-04-154
60 mm



FINSEN AS-04-155
50 mm



FINSEN AS-04-156
70 mm



FINSEN modif. AS-04-157
75 mm



AS-04-158
45 mm



AS-04-159
55 mm



MUELLER AS-04-160
65 mm



ALM AS-04-161 7 cm
AS-04-162 10 cm



AS-04-161



AS-04-162

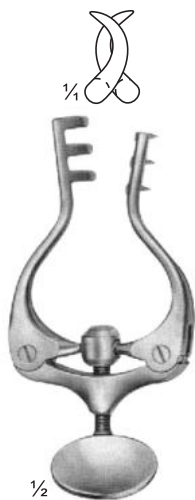

JANSEN AS-04-163
100 mm



JANSEN AS-04-164
100 mm



1/2
ADSON-BABY Blunt
AS-04-165
14 cm

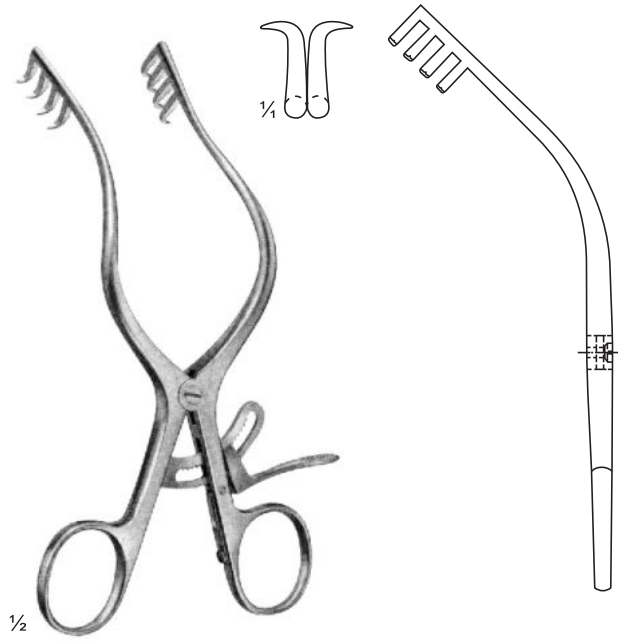

1/2
MOLLISON Sharp
AS-04-166 15,5 cm

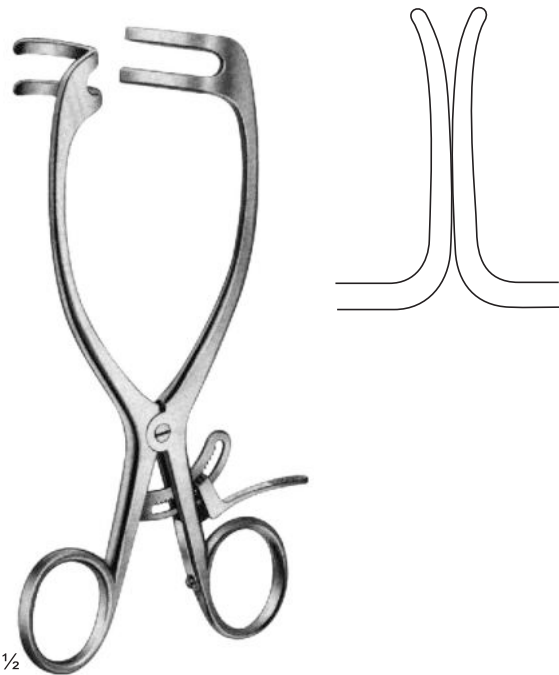

1/2
MAYO-ADAMS
AS-04-167
16,5 cm



1/2
TRAVERS
AS-04-168
21,5 cm

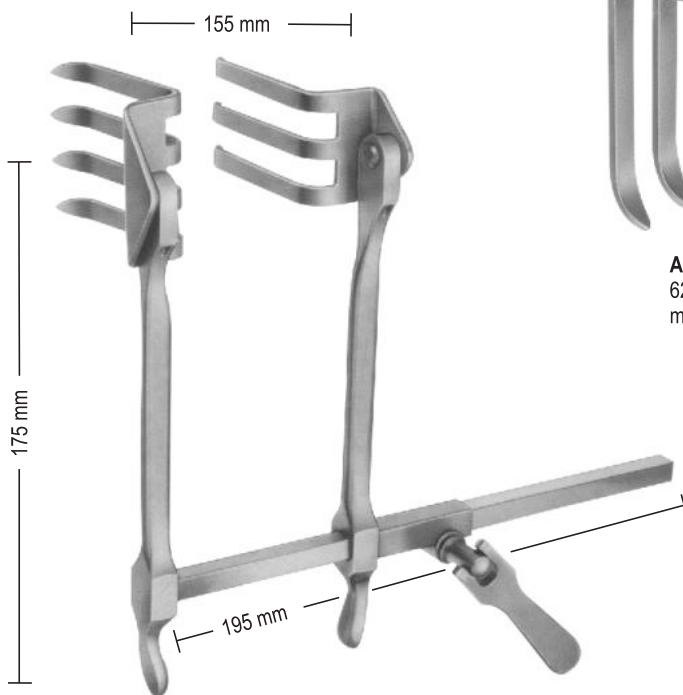

AS-04-169 - AS-04-172
SCOVILLE-RICHTER
Retractor with 1 pair
blades reversible type.
The Retractor bar and
shanks may be easily
rotated 180 when
blades are in situ.



AS-04-169
62 x 52 mm 62 x 37
mm PR= Pair



AS-04-170
47 x 51 mm



AS-04-171
30 x 40 mm



AS-04-172
37 x 62 mm

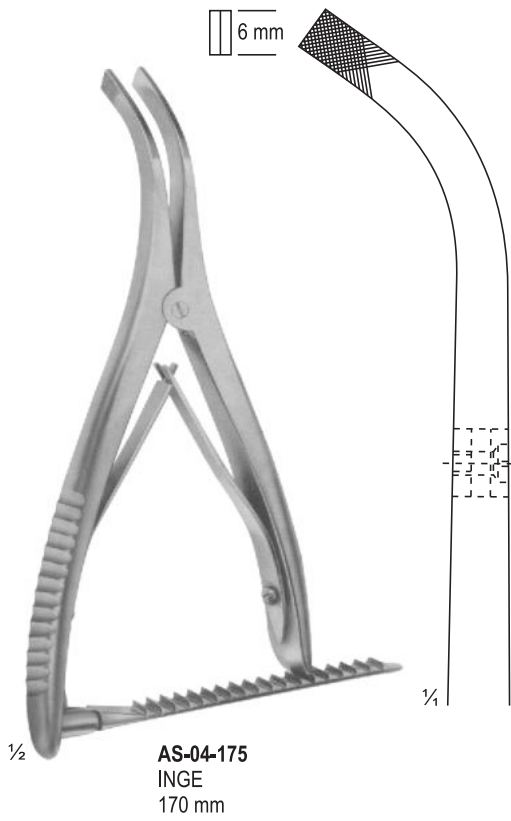
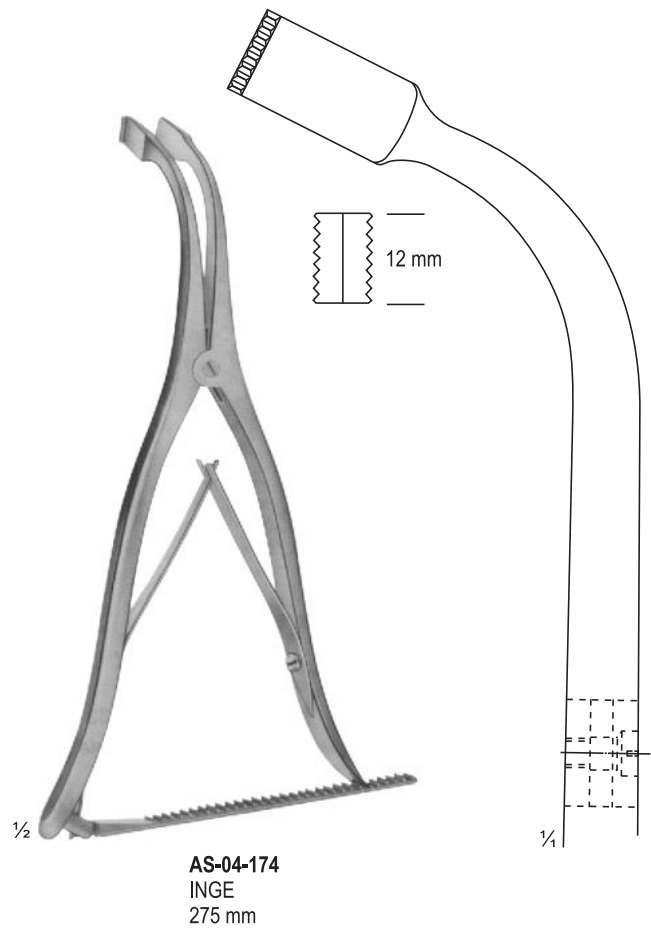
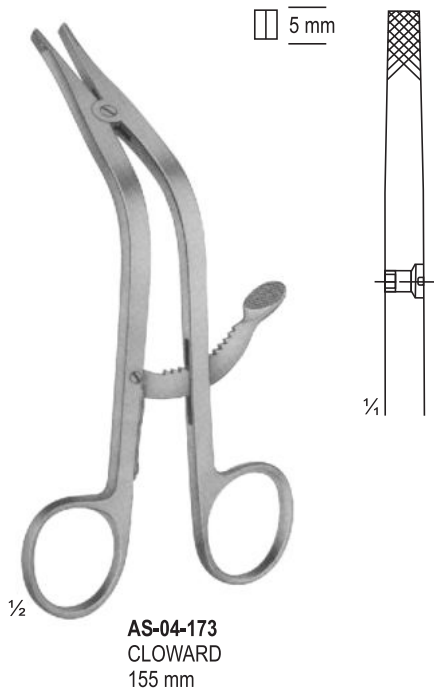



WEITLANER Sharp
AS-04-176
11 cm



WEITLANER Semi-Sharp
AS-04-177
11 cm



WEITLANER Blunt
AS-04-178
11 cm



WEITLANER Sharp
AS-04-179 13 cm



WEITLANER Semi-Sharp
AS-04-180 13 cm



WEITLANER Blunt
AS-04-181 13 cm

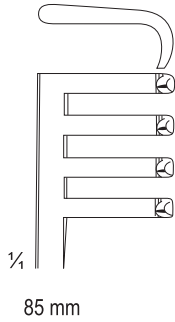

1/2

HENLEY
Complete with 3 Central Baldes
AS-04-182 - AS-04-184
16.5 cm



Blades
AS-04-182
19 X 17 mm



Blades
AS-04-183
25 X 17 mm



Blades
AS-04-184
32 X 17 mm



1/2

JOLL (FRIEDMAN)
AS-04-185
 Thyroid and Vaginal Retractor
 15.5 cm

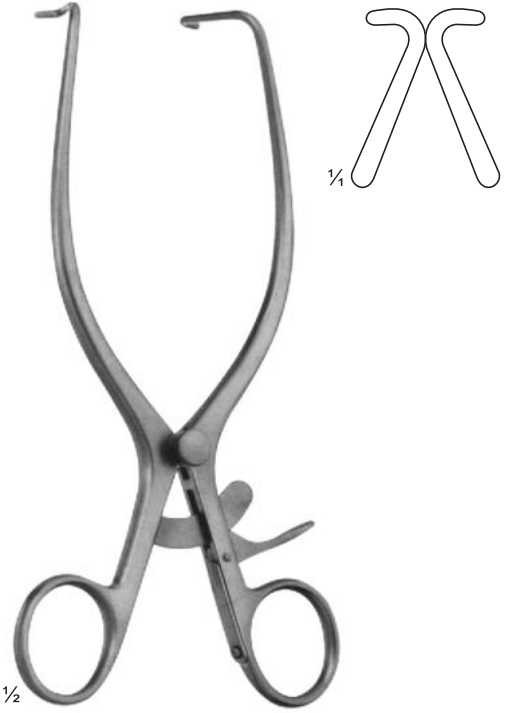

1/2

JACKSON BURROWS
AS-04-186
 Retractor, blunt
 18.5 cm

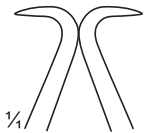

1/4



1/2

GELPI
AS-04-187
 13.5 cm

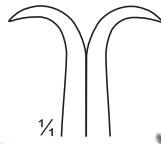

1/4



1/2

GELPI
AS-04-188
 17.5 cm

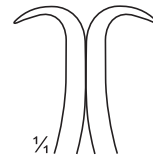

1/4



1/2

DE BAKKEY
AS-04-189
 14.5 cm



½

O'SULLIVAN-O'CONNOR
AS-04-190 - AS-04-192



1



2



3

Blades for
Fig. 1 = **AS-04-190** 45 X 17 mm
Fig. 2 = **AS-04-191** 90 X 37 mm
Fig. 3 = **AS-04-192** 90 X 45 mm



CLOWARD modif. Spreader Only
AS-04-193 - AS-04-202



16 mm
AS-04-193

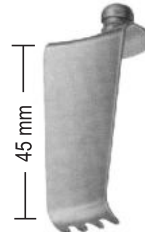

16 mm
AS-04-194

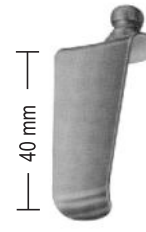

16 mm
AS-04-195

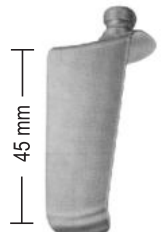

16 mm
AS-04-196

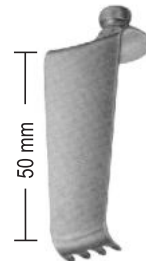

16 mm
AS-04-197

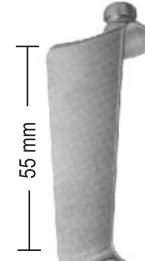

16 mm
AS-04-198

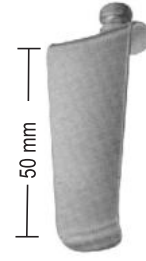

16 mm
AS-04-199

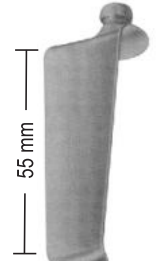

16 mm
AS-04-200

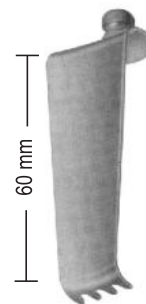

16 mm
AS-04-201

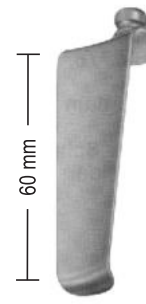

16 mm
AS-04-202



CLOWARD-TYPE
AS-04-203
25.5 cm
with ball snap closure Cervical Retractor
complete consisting of Retractor Body
25.5 cm, 110 mm spread (without blades)



AS-04-204 - AS-04-208
AS-04-204 15 x 40 mm
AS-04-205 15 x 45 mm
AS-04-206 15 x 50 mm
AS-04-207 15 x 55 mm
AS-04-208 15 x 60 mm
serrated



AS-04-209 - AS-04-213
AS-04-209 15 x 40 mm
AS-04-210 15 x 45 mm
AS-04-211 15 x 50 mm
AS-04-212 15 x 55 mm
AS-04-213 15 x 60 mm
Blunt

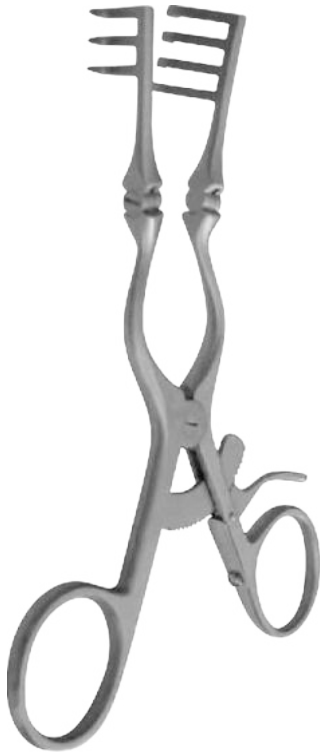

CONE

AS-04-214 - AS-04-221

AS-04-214 14 cm, 18 mm 3 x 4

AS-04-215 16 cm, 18 mm 3 x 4

AS-04-216 20 cm, 20 mm 3 x 4

AS-04-217 24 cm, 27 mm 3 x 4

AS-04-218 14 cm, 18 mm 3 x 4

AS-04-219 16 cm, 18 mm 3 x 4

AS-04-220 20 cm, 20 mm 3 x 4

AS-04-221 24 cm, 27 mm 3 x 4

prongs blunt



MARKHAM-MEYERDING

AS-04-222

18 cm, 50 x 25 mm left

Hemilaminectomy Retractor



MARKHAM-MEYERDING

AS-04-223

18 cm, 50 x 25 mm right

Hemilaminectomy Retractor



MINI-WEITLANER

AS-04-224 - AS-04-225

AS-04-224 11 cm, 16 mm 2 x 3 prongs sharp

AS-04-225 11 cm, 16 mm 2 x 3 prongs blunt



WEITLANER

AS-04-226 - AS-04-233

AS-04-226 13 cm, 18 mm 3 x 4 prongs sharp

AS-04-227 16 cm, 18 mm 3 x 4 prongs sharp

AS-04-228 20 cm, 21 mm 3 x 4 prongs sharp

AS-04-229 25 cm, 27 mm 3 x 4 prongs sharp

AS-04-230 13 cm, 18 mm 3 x 4 prongs blunt

AS-04-231 16 cm, 18 mm 3 x 4 prongs blunt

AS-04-232 20 cm, 21 mm 3 x 4 prongs blunt

AS-04-233 25 cm, 27 mm 3 x 4 prongs blunt



ANDERSON-ADSON

Cerebellar Retractor

AS-04-234 20 cm

4 x 4 prongs sharp



WEITLANER
AS-04-235 - AS-04-236
AS-04-235 26 cm, 27 mm 5 x 6 prongs sharp
AS-04-236 26 cm, 27 mm 5 x 6 prongs blunt



HEMILAMINECTOMY
AS-04-237 - AS-04-238
AS-04-237 29 cm, 42 mm 6 x 6 prongs sharp
AS-04-238 29 cm, 42 mm 6 x 6 prongs blunt



AS-04-239 - AS-04-242
 Right blade 42 mm, left blade 22 mm deep
AS-04-239 29 cm, 22/42 mm 6 x 6 prongs sharp
AS-04-240 29 cm, 22/42 mm 6 x 6 prongs blunt
 Right blade 22 mm, left blade 42 mm deep
AS-04-241 29 cm, 22/42 mm 6 x 6 prongs sharp
AS-04-242 29 cm, 22/42 mm 6 x 6 prongs blunt



SCALP CONTOUR

AS-04-243 - AS-04-246

- AS-04-243 14 cm, 18 mm 1 x 1 prongs blunt
- AS-04-244 14 cm, 18 mm 3 x 3 prongs blunt
- AS-04-245 14 cm, 18 mm 3 x 4 prongs sharp
- AS-04-246 14 cm, 18 mm 3 x 4 prongs blunt



BECKMANN-ADSON

AS-04-247 - AS-04-252

- AS-04-247 31 cm, 25 mm 4 x 4 prongs sharp
- AS-04-248 31 cm, 37 mm 4 x 4 prongs sharp
- AS-04-249 31 cm, 48 mm 4 x 4 prongs sharp
- AS-04-250 31 cm, 25 mm 4 x 4 prongs blunt
- AS-04-251 31 cm, 37 mm 4 x 4 prongs blunt
- AS-04-252 31 cm, 48 mm 4 x 4 prongs blunt



BECKMANN-EATON

AS-04-253

- 32 cm, 50 mm 7 x 7 prongs sharp

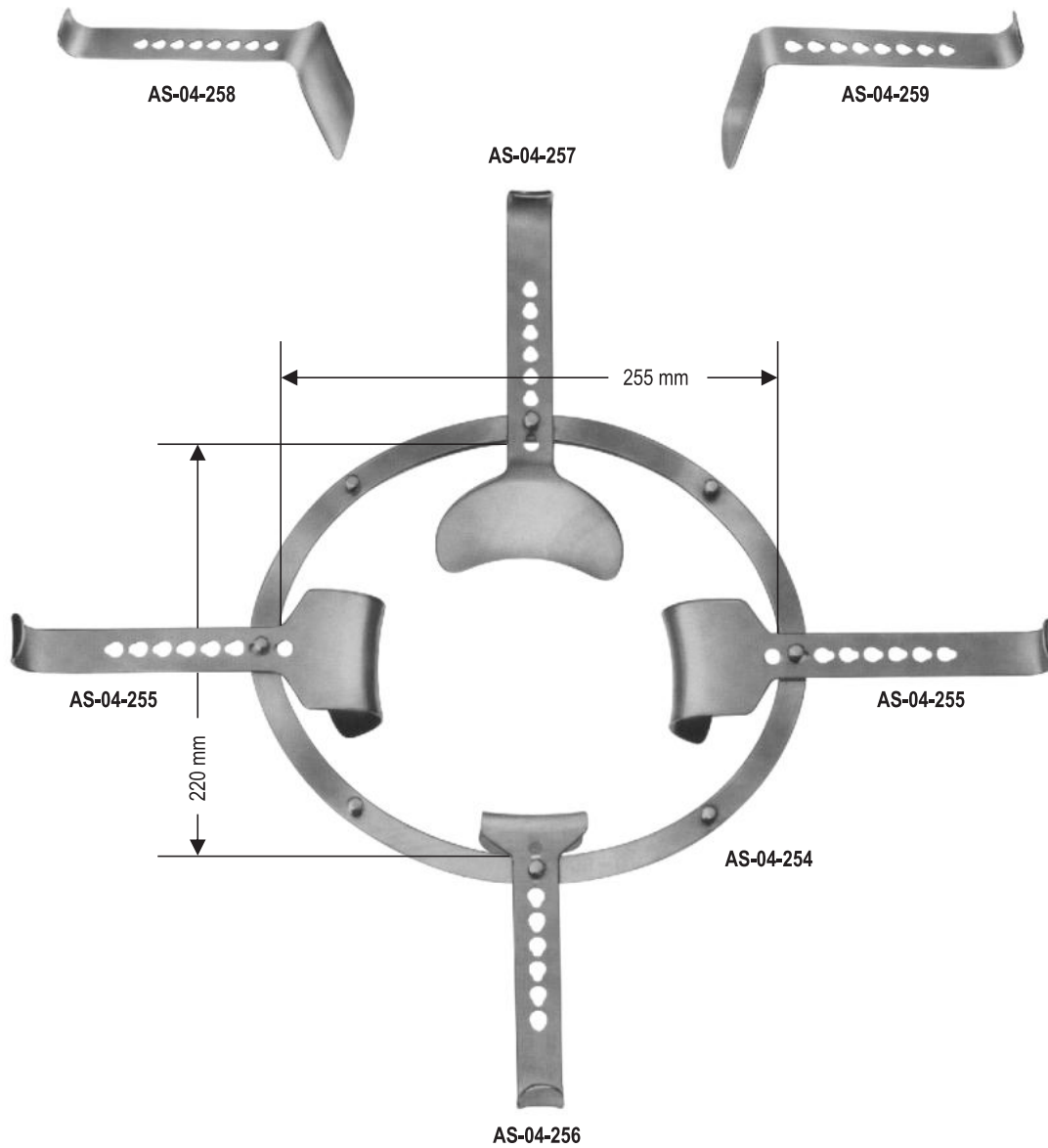

AS-04-254 - AS-04-259 SEMM

consisting of:

- AS-04-254** 1 frame 225 x 220 mm
- AS-04-255** 2 blades 46 x 64 mm
- AS-04-256** 1 blade 53 x 54 mm
(for bladder)
- AS-04-257** 1 blade 82 x 97 mm
(for intestine)
- AS-04-258** 1 blade 98 x 51 mm
(for intestine)
- AS-04-259** 1 blade, narrow
107 x 36 mm

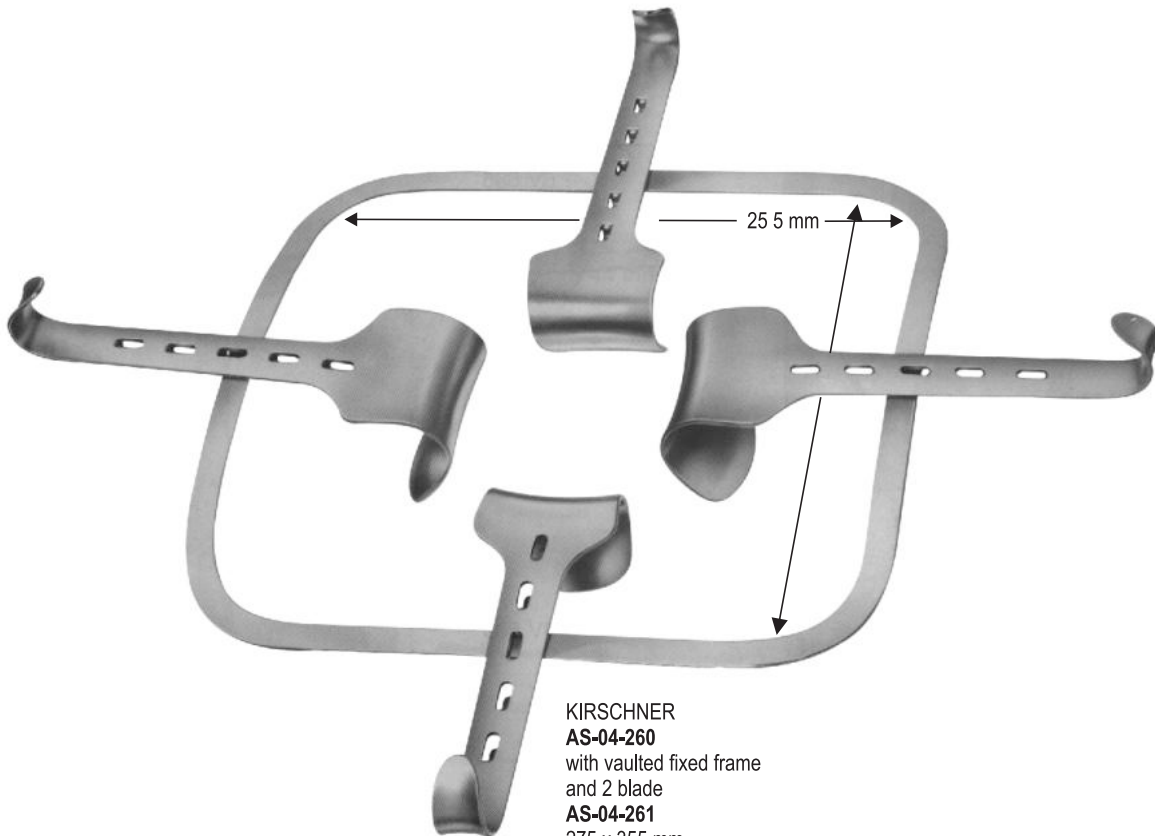

KIRSCHNER
AS-04-260
 with vaulted fixed frame
 and 2 blade
AS-04-261
 275 x 355 mm
 Frame only, over-sized
AS-04-262
 295 x 275 mm
 Frame only



AS-04-263
 KIRSCHNER
 64 x 80 mm



AS-04-264
 KIRSCHNER-BALFOUR
 80x 82 mm



AS-04-265 - AS-04-267
 KIRSCHNER
AS-04-265 90x 69mm
AS-04-266 92x 95mm
AS-04-267 78x 58mm



AS-04-268 - AS-04-270
 KIRSCHNER
AS-04-268 108x42mm
AS-04-269 91x 55mm
AS-04-270 121x 55mm



ASAMAR
SURGICAL 

PAGE

103-111

SPONGE AND DRESSING FORCEPS
WASHING FORCEPS
ORGAN AND TISSUE GRASPING FORCEPS
TOWEL CLAMPS

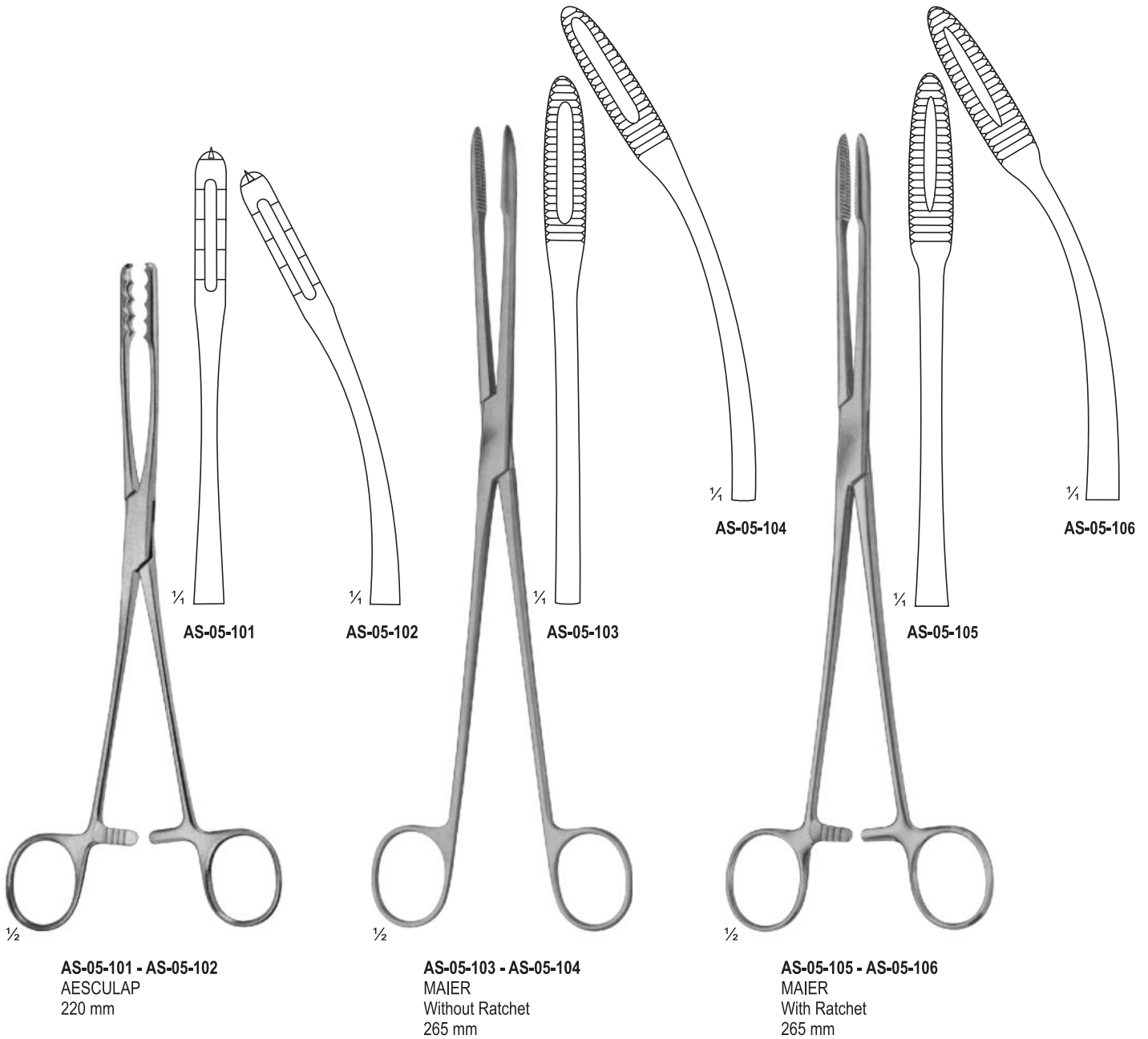

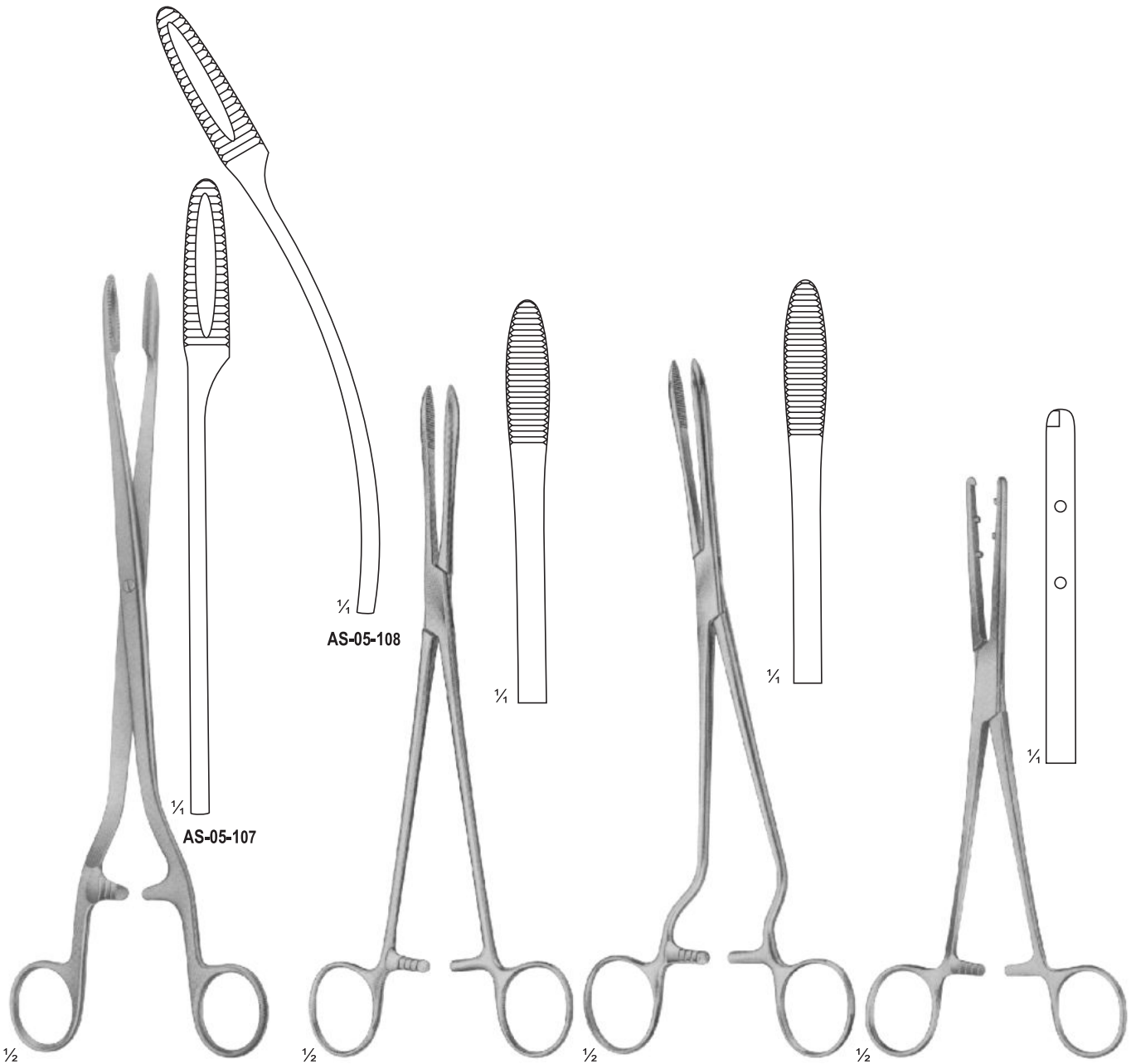

AS-05-107 - AS-05-108
SIMS-MAIER
280 mm

AS-05-109
COLLIN 240
mm

AS-05-110 CHERON
Handles Laterally Angled
240 mm

AS-05-111
EMMET
210 mm

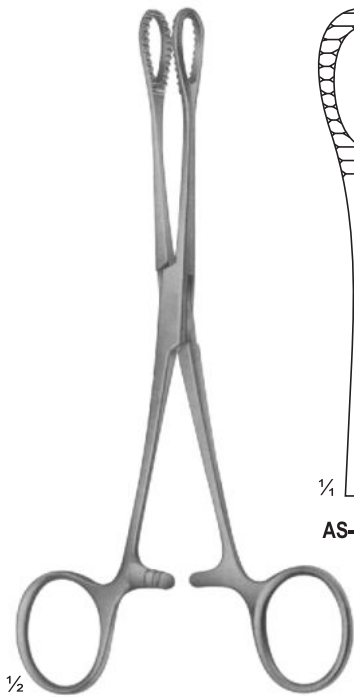

AS-05-112 - AS-05-113
FOERSTER-BALLENGER
180 mm

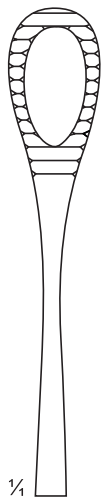

AS-05-112



AS-05-113



AS-05-114 - AS-05-115
RAMPLEY

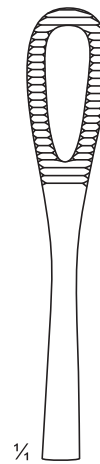

AS-05-114
180 mm

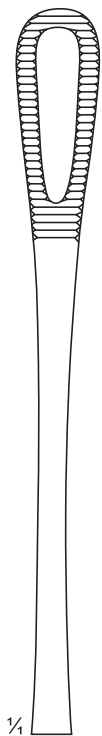

AS-05-115
250 mm

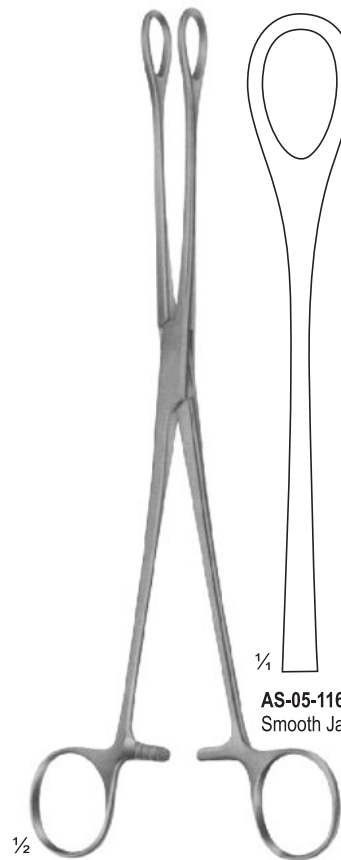

AS-05-116 - AS-05-119
FOERSTER-BALLENGER
240 mm

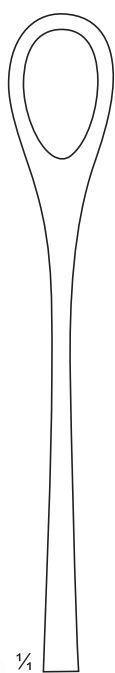

AS-05-116
Smooth Jaws

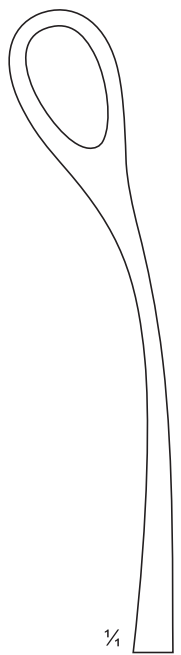

AS-05-117
Smooth Jaws

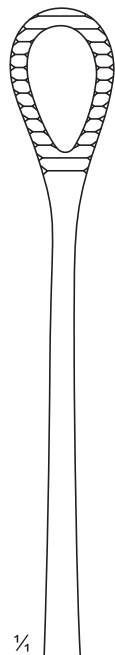

AS-05-118
Serrated Jaws

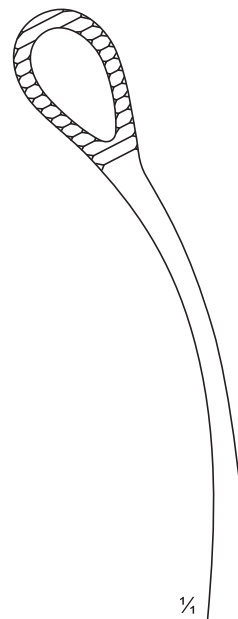

AS-05-119
Serrated Jaws

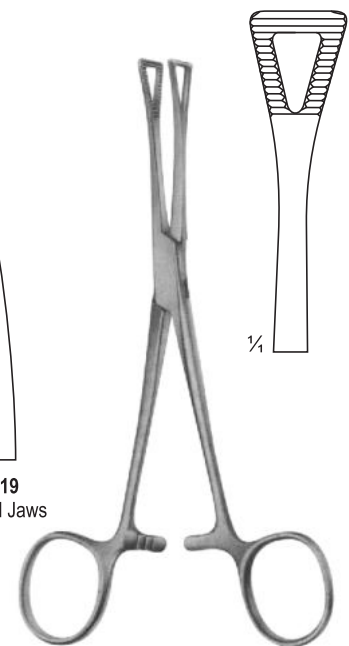

AS-05-120
PENNINGTON
155 mm

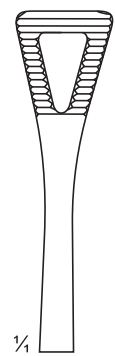

SPONGE AND DRESSING FORCEPS

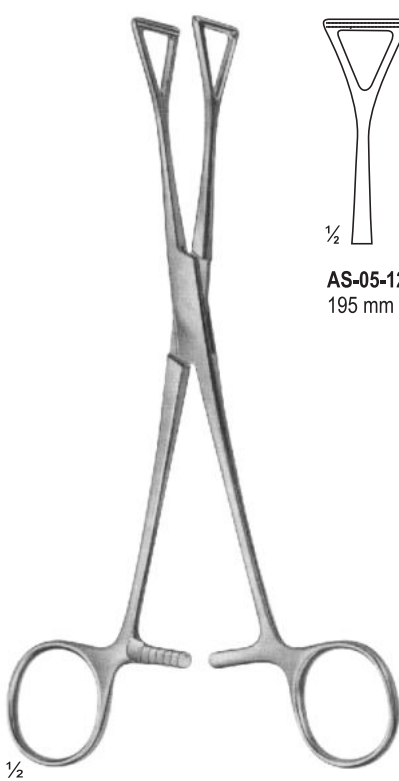

AS-05-121 - AS-05-122
COLLIN

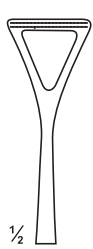

AS-05-121
195 mm

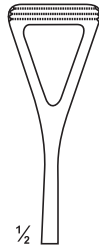

AS-05-122
230 mm



AS-05-123 - AS-05-125
COLLIN

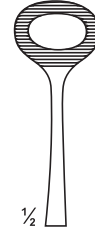

AS-05-123
160 mm



AS-05-124
160 mm



AS-05-125
170 mm

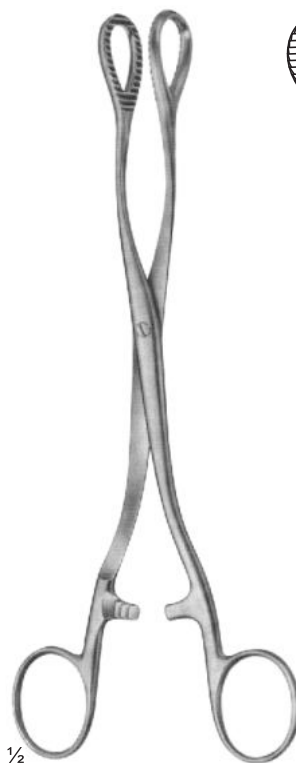

AS-05-126
HEYWOOD-SMITH
200 mm

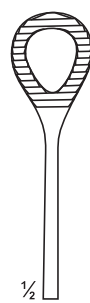

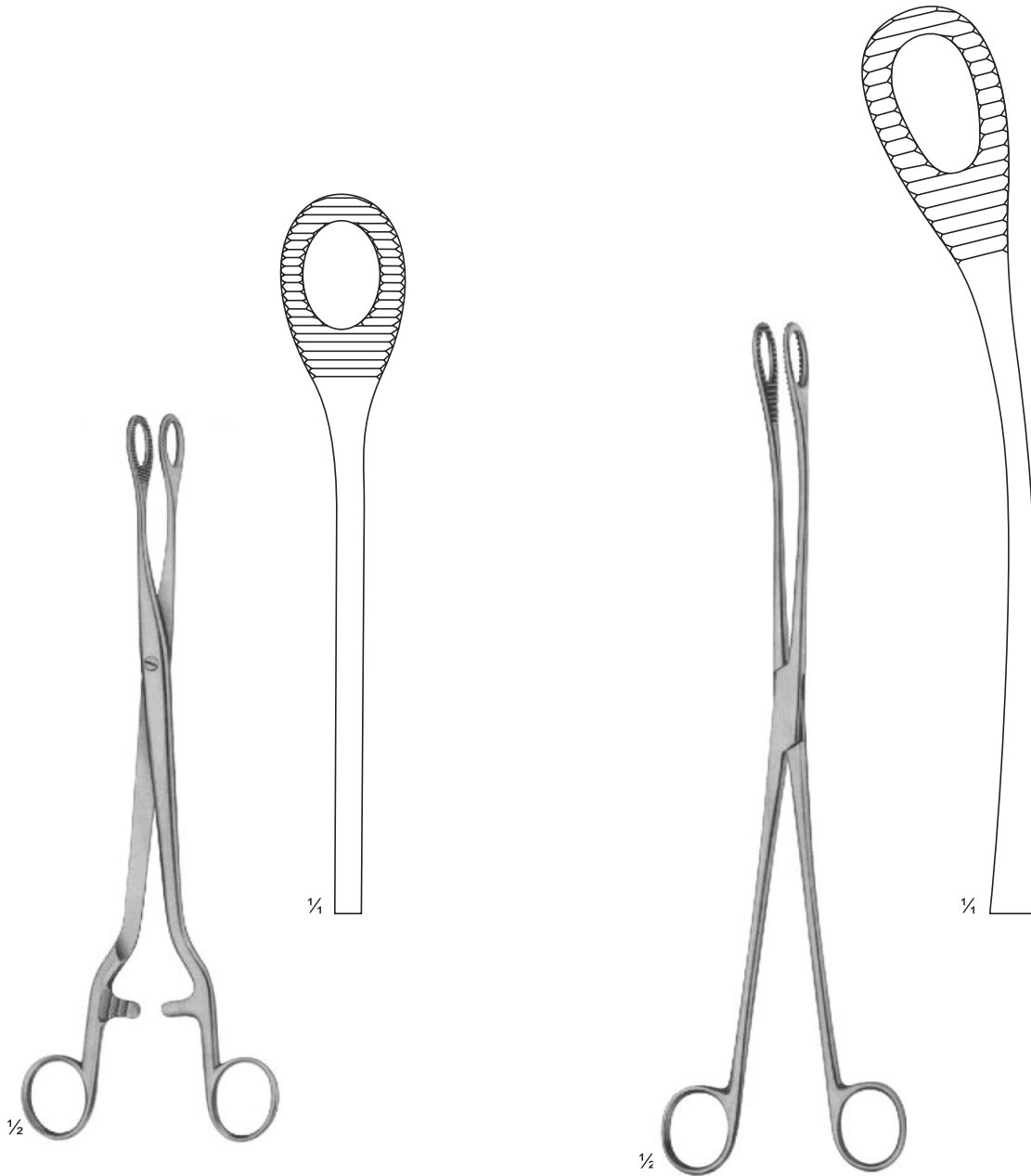

AS-05-127
NOTO
280 mm

AS-05-128
KELLY
320 mm



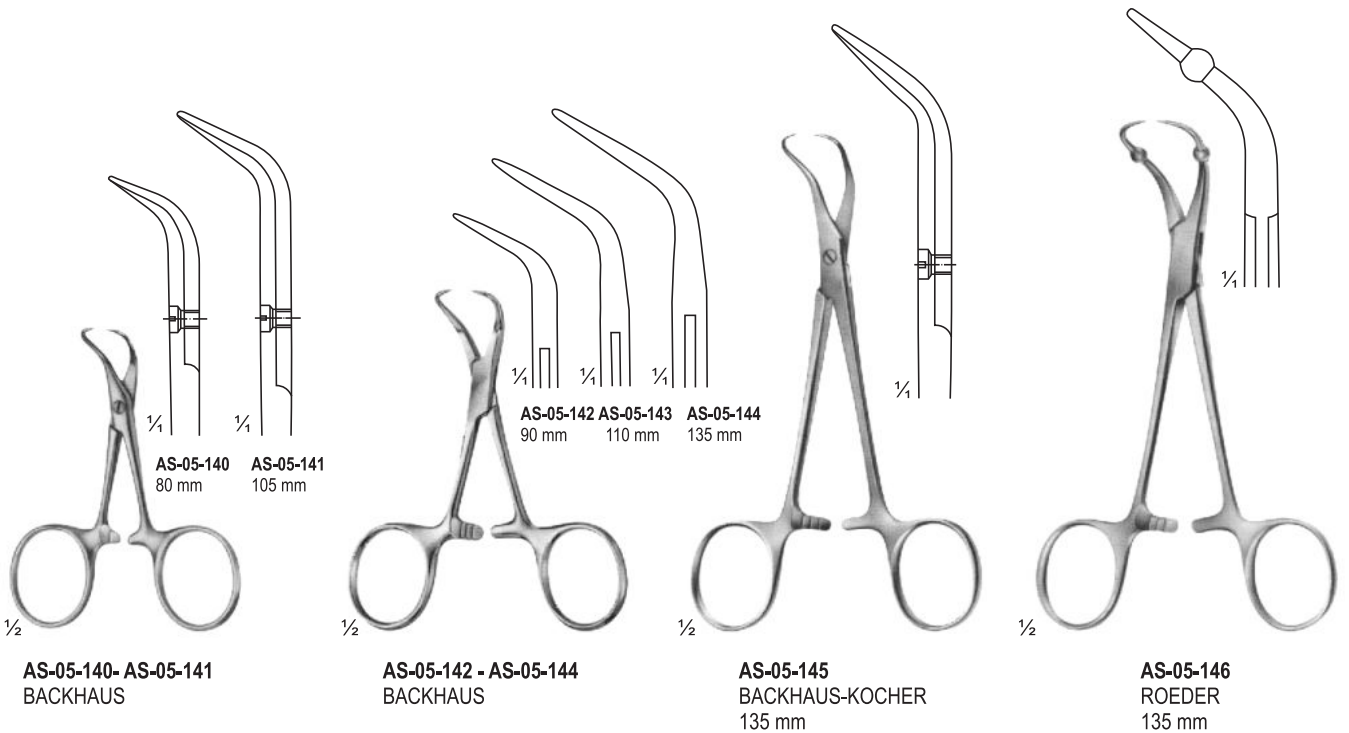
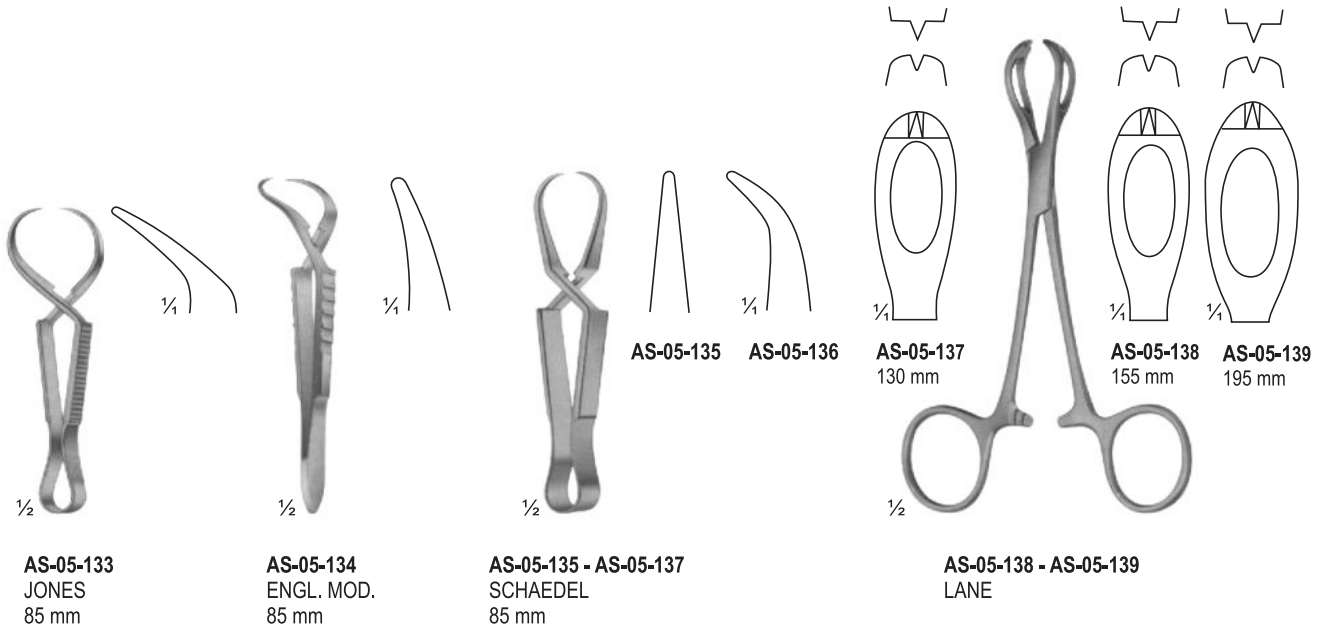



HERZ
AS-05-147 - AS-05-148
155 mm

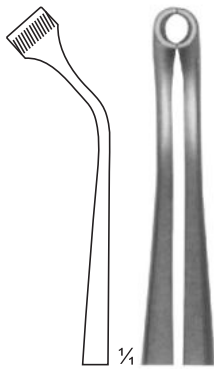

AS-05-147

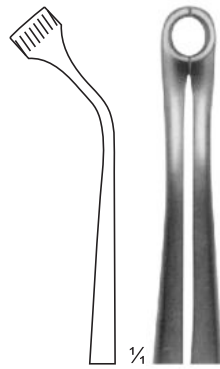

AS-05-148



JACKSON
4 x 5 teeth
AS-05-149
150 mm

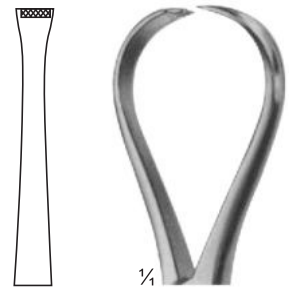

AS-05-149

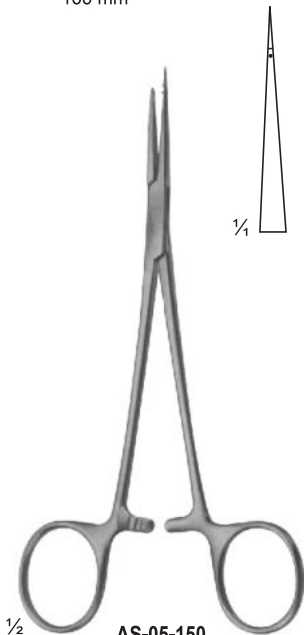

AS-05-150
150 mm

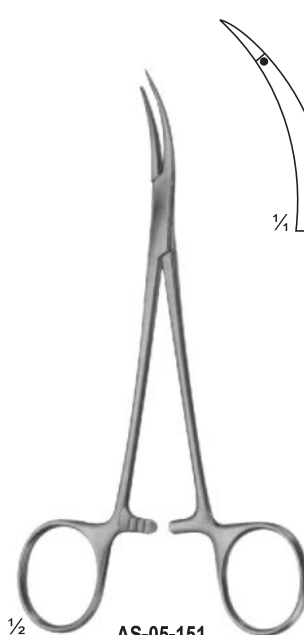
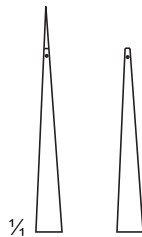

AS-05-151
150 mm

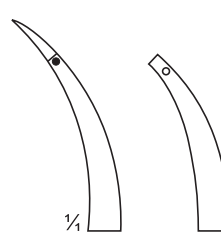

AS-05-152
120 mm

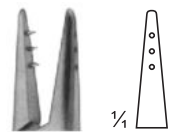

JAGER
Tendon-and cross
ligament passing forceps
flexible shaft
AS-05-153
275 mm



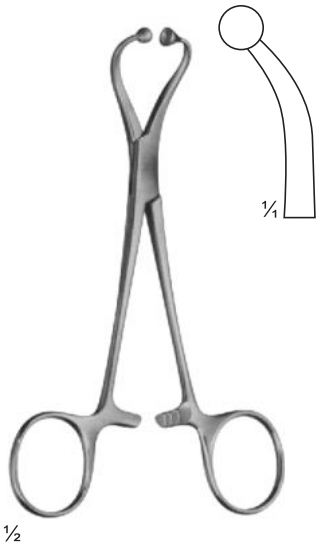

AS-05-154
for paper
cloths 140 mm

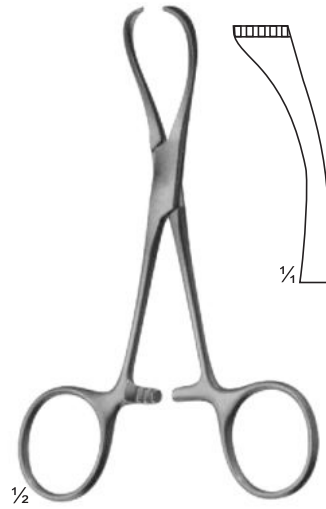

AS-05-155
LORNA
non
perforating
130 mm



AS-05-156
BUNT
105 mm



AS-05-157
MAYO
140 mm



ASAMAR
SURGICAL 

PAGE
112-130
BONE PUNCHES
RONGEURS
AMPUTATION

90° upwards cutting

AS-06-101
4 mm



¼

AS-06-102
5 mm



¼

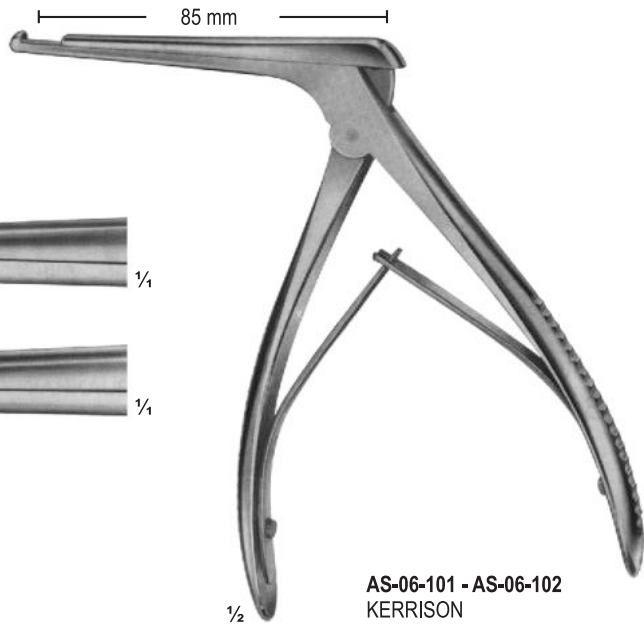

AS-06-101 - AS-06-102
KERRISON

½

90° upwards cutting

AS-06-103
3,3 mm



¼

AS-06-104
4,0 mm

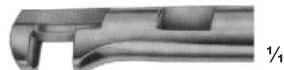

¼

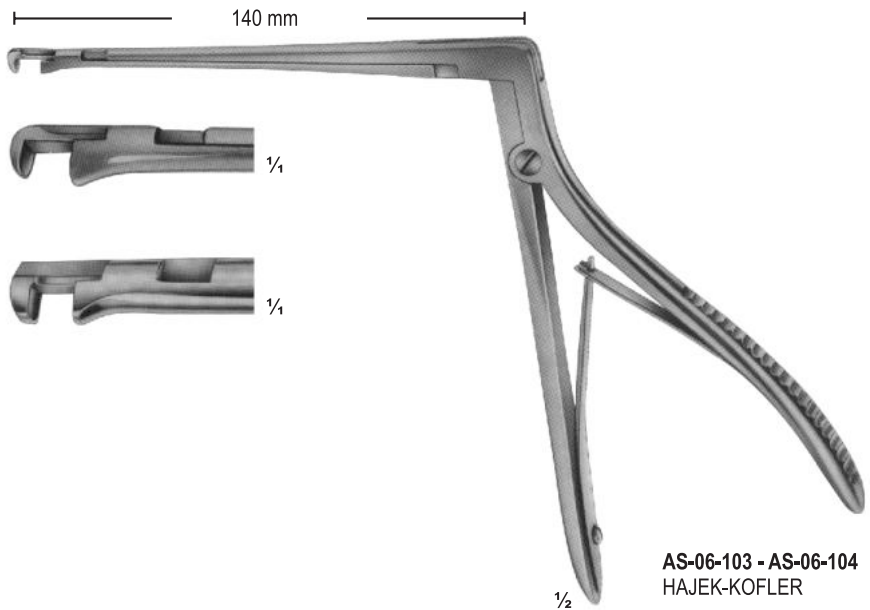

AS-06-103 - AS-06-104
HAJEK-KOFLER

½

130°

upwards cutting

140 mm

AS-06-105
1 mm



AS-06-106
2 mm



AS-06-107
3 mm



AS-06-108
4 mm



AS-06-109
5 mm



1/2

AS-06-105 - AS-06-109
KERRISON-JACOBY

90°

upwards cutting

180 mm

AS-06-110
1 mm



AS-06-111
2 mm



FERRIS-SMITH-KERRISON

AS-06-112
3 mm



AS-06-113
4 mm



AS-06-114
5 mm



1/2

AS-06-110 - AS-06-114
KERRISON-JACOBY

Angled positions for rongeurs

AS-06-115 3,0 mm

AS-06-116
3,6 mm

AS-06-117
4,2 mm

AS-06-118
4,8 mm

AS-06-119
5,8 mm

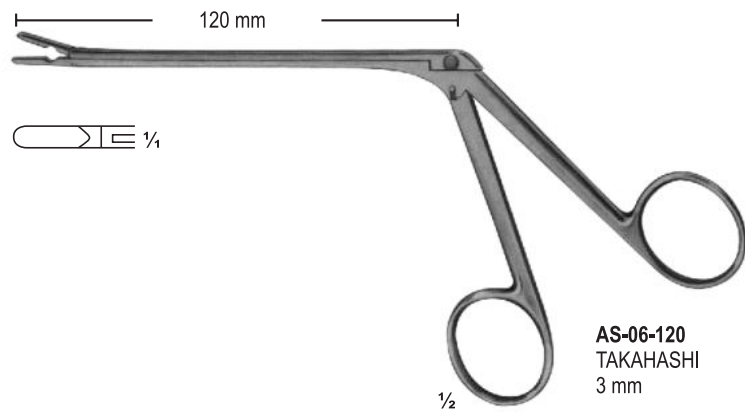
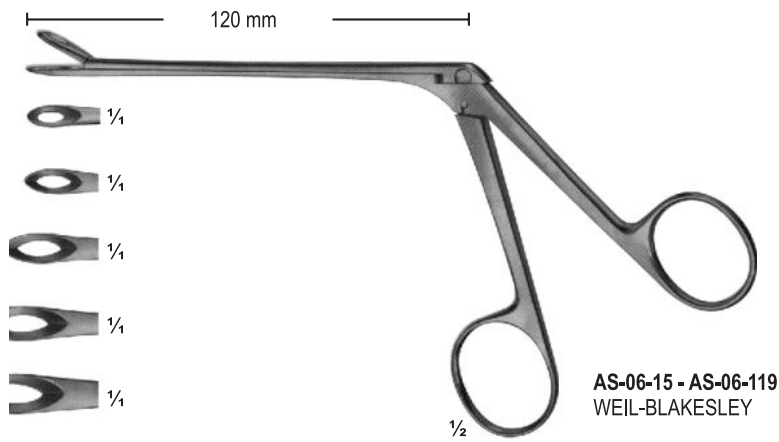

130°

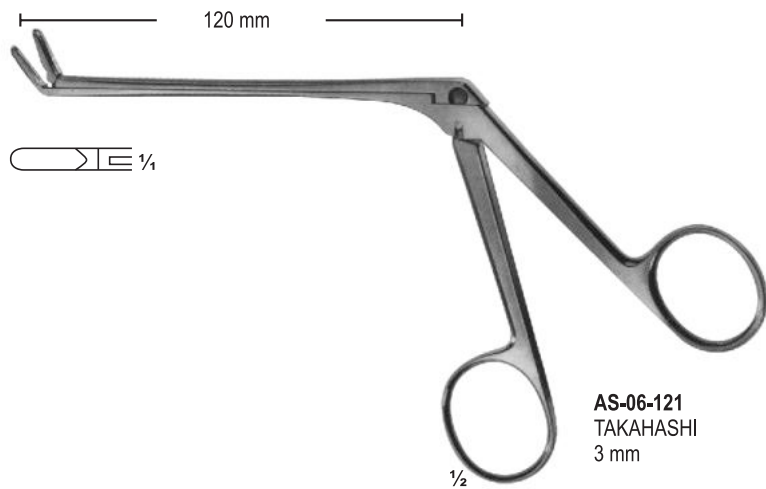

AS-06-122
2 X 10 mm

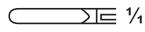

AS-06-123
3 X 10 mm



AS-06-124
4 X 10 mm

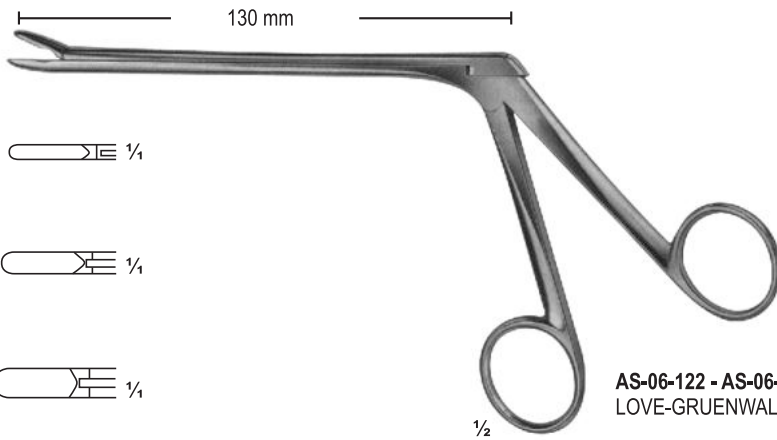
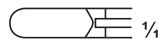

AS-06-122 - AS-06-124
LOVE-GRUENWALD

AS-06-125
2 mm

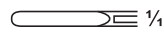

AS-06-126
3 mm

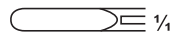

AS-06-127
4 mm



AS-06-128
5 mm

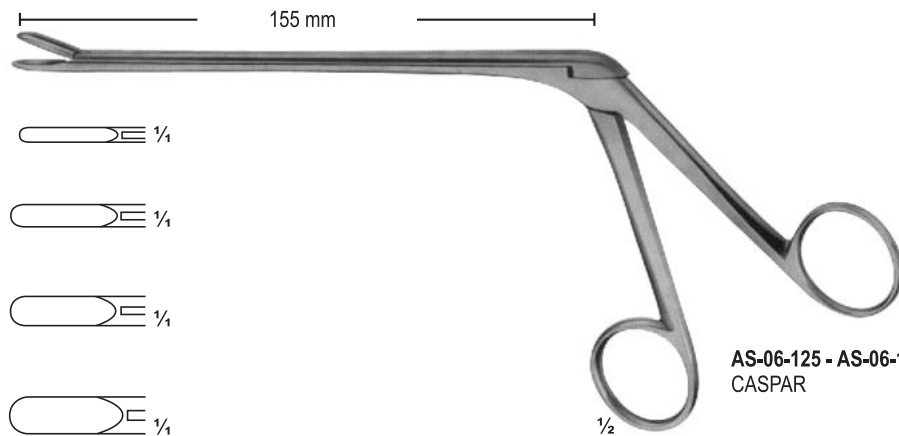

AS-06-125 - AS-06-128
CASPAR

AS-06-129
2 mm



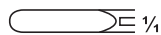

AS-06-130
3 mm

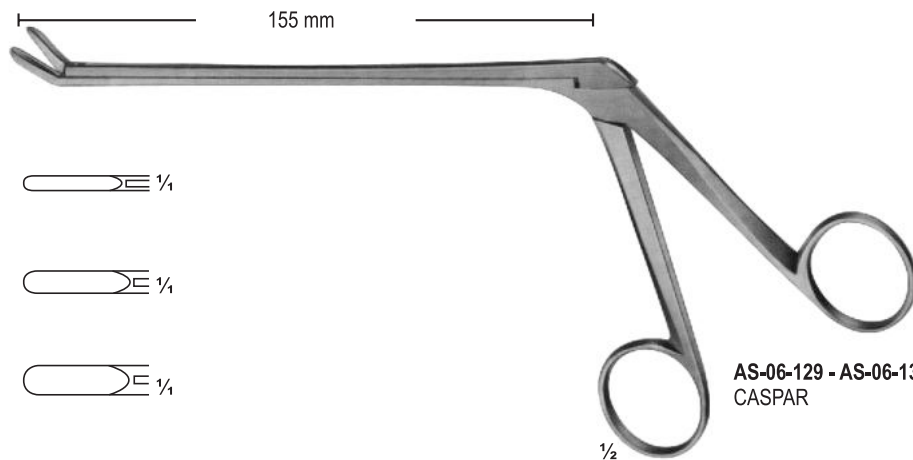

AS-06-131
4 mm



AS-06-129 - AS-06-131
CASPAR

Length of shaft 140 mm	Length of shaft 160 mm	Length of shaft 185 mm	size of jaws
AS-06-132	AS-06-134	AS-06-136	3 X12 mm  1/4
AS-06-133	AS-06-135	AS-06-137	4 X14 mm  1/4

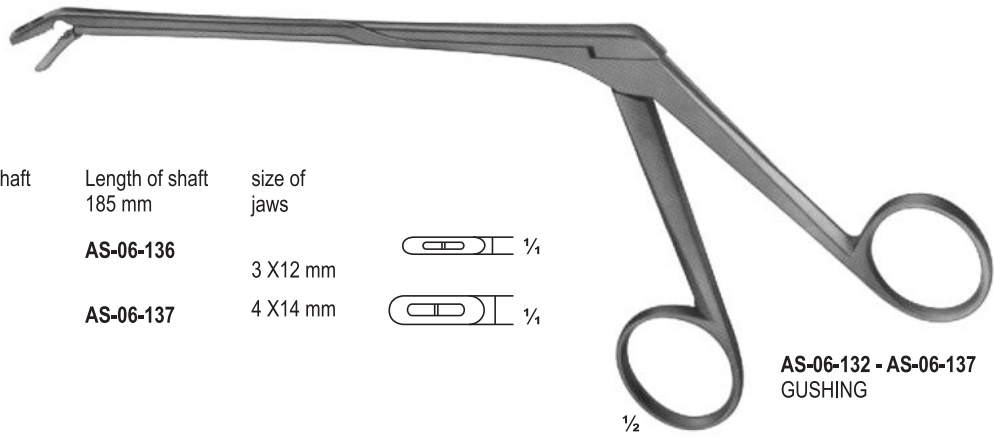

AS-06-138
2 X 10 mm
GUSHING



AS-06-139
3 X 10 mm LOVE-GRUENWALD

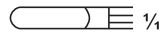

AS-06-140
4 X 10 mm
SPURLING

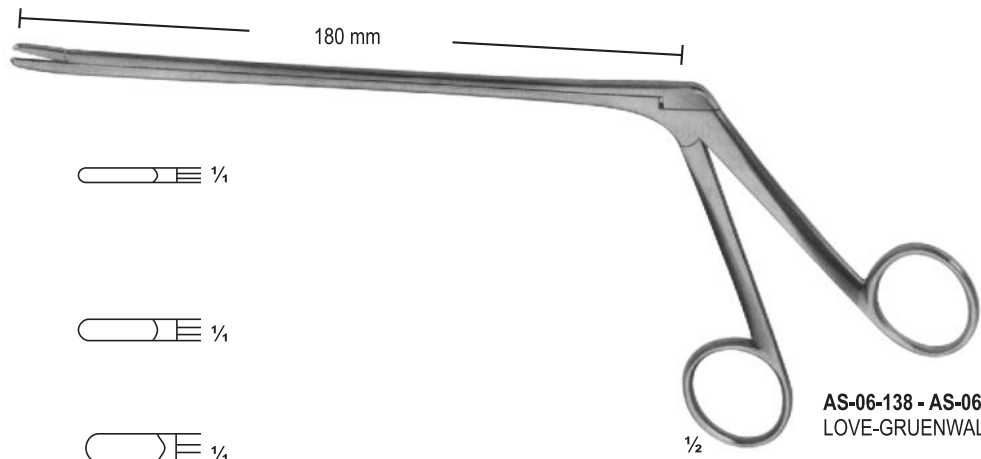
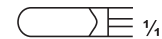

AS-06-141
3 X 10 mm LOVE-GRUENWALD



AS-06-142 4 X 10 mm
SPURLING

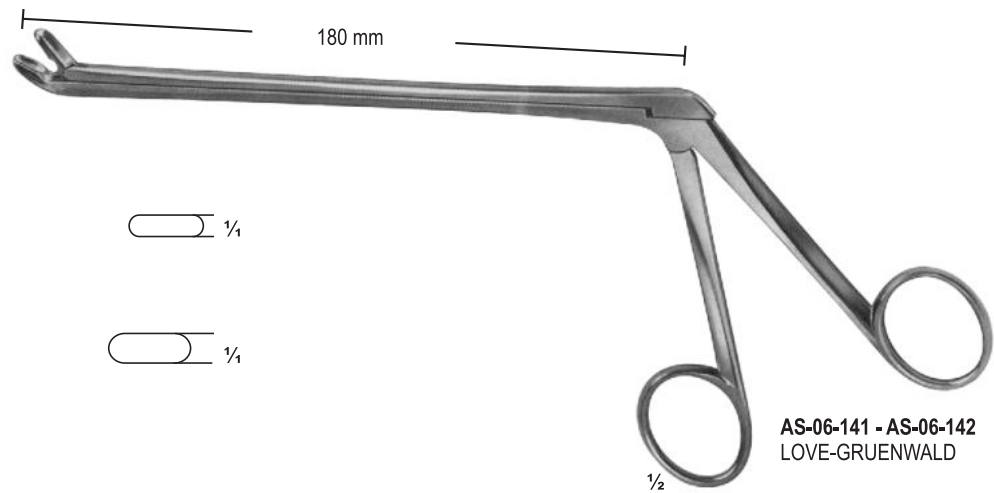

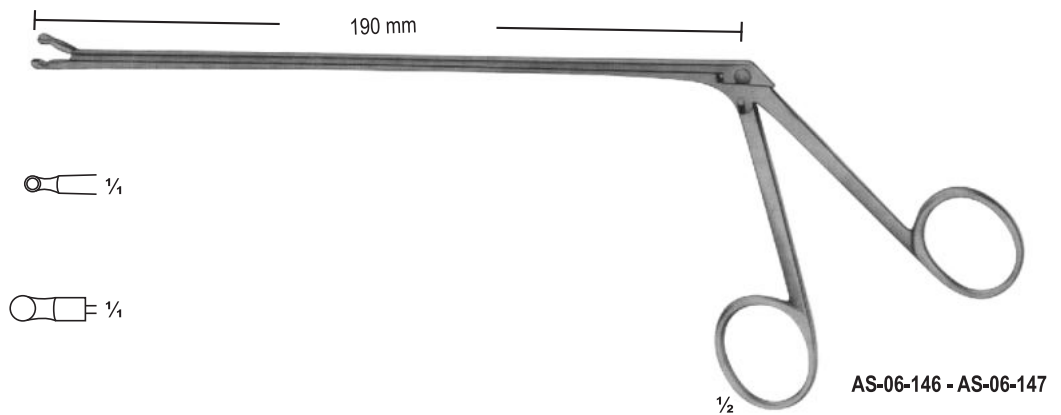
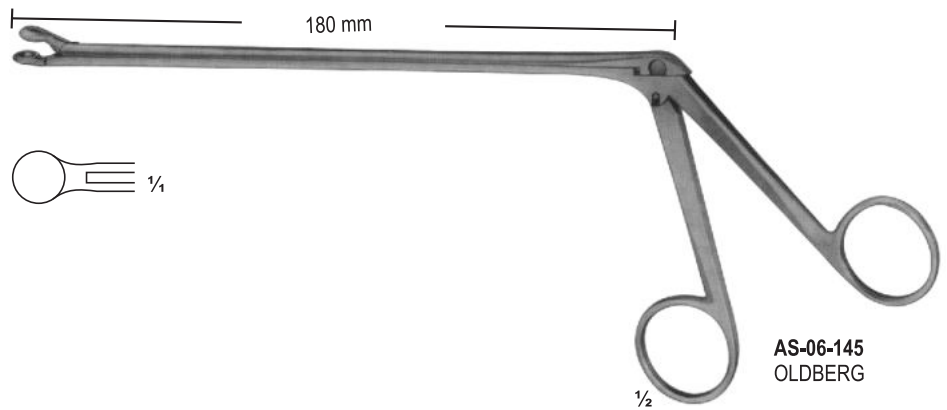
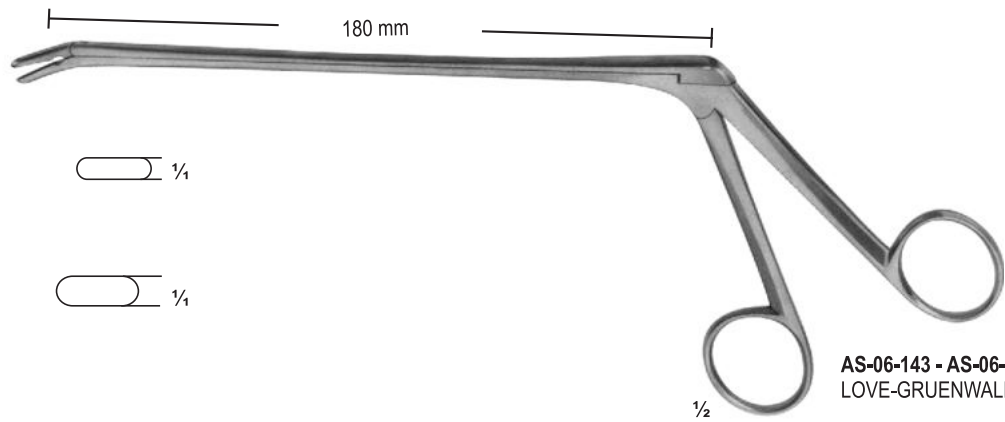

AS-06-148
4 mm



145 mm

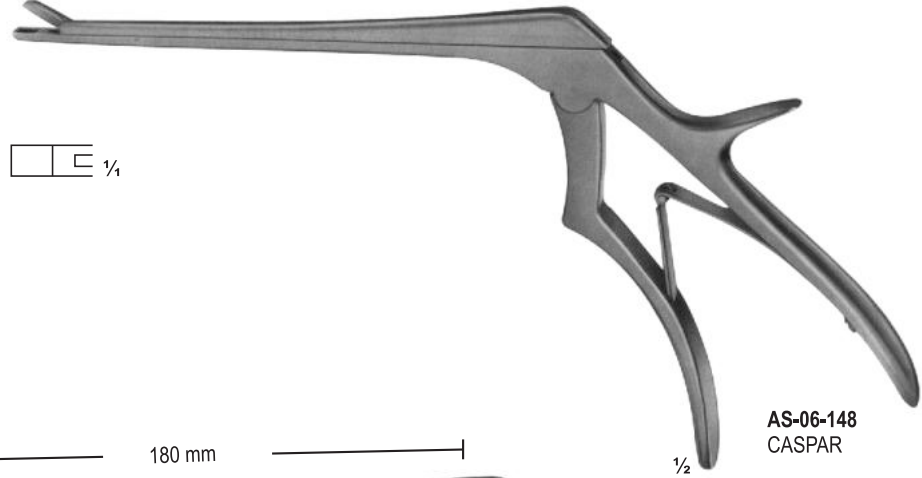

AS-06-148
CASPAR

1/2

AS-06-149
4 mm



180 mm

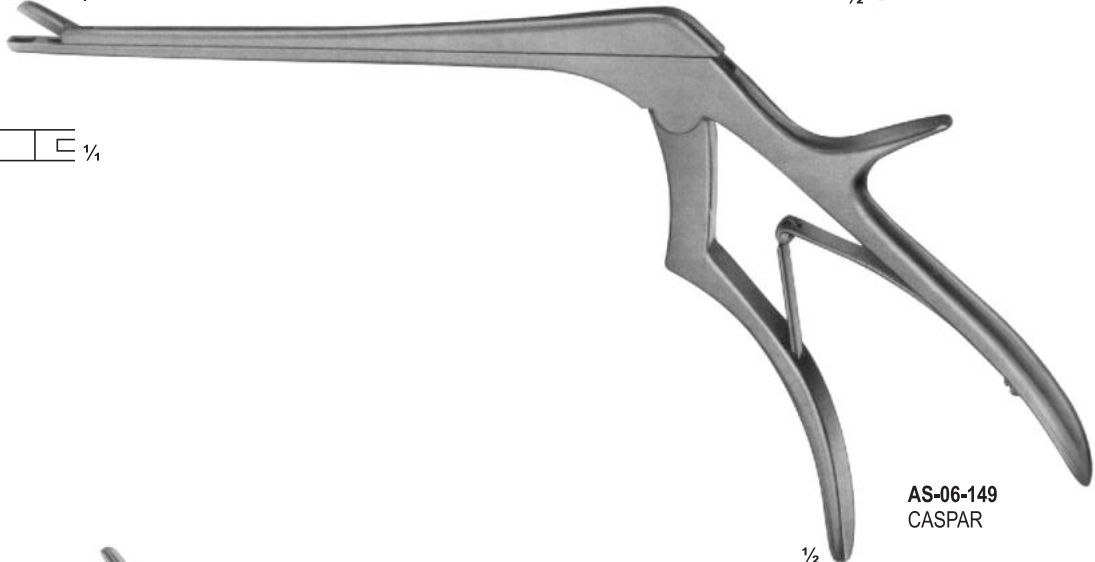

AS-06-149
CASPAR

1/2

AS-06-150
5,5 mm



200 mm



AS-06-150
WAGNER

1/2



90° upwards cutting

85 mm

AS-06-151
4 mm



1/4

AS-06-152
5 mm



1/4

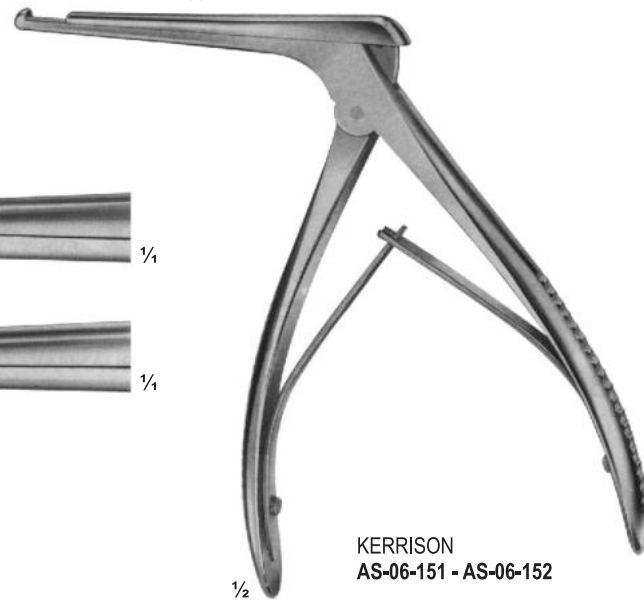

KERRISON
AS-06-151 - AS-06-152

1/2

90° upwards cutting

140 mm

AS-06-153
3.3 mm



1/4

AS-06-154
4 mm



1/4

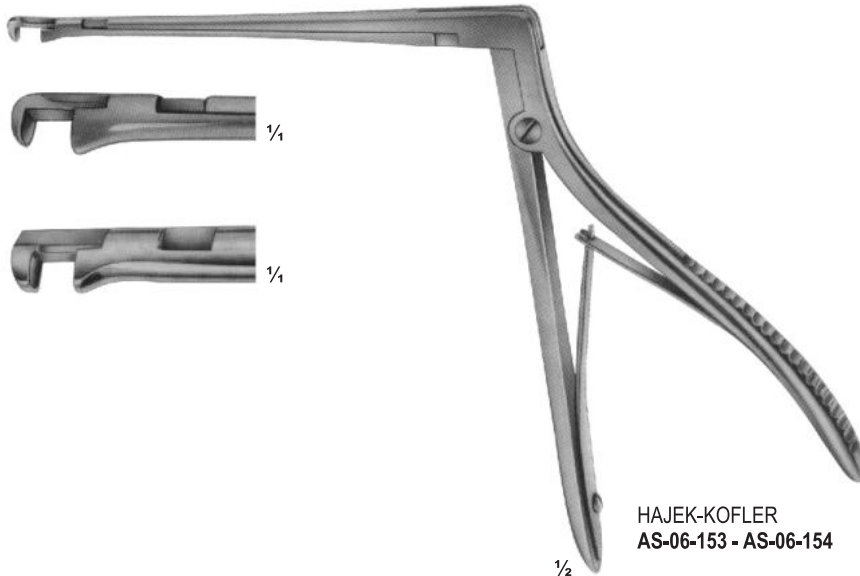

HAJEK-KOFLER
AS-06-153 - AS-06-154

1/2

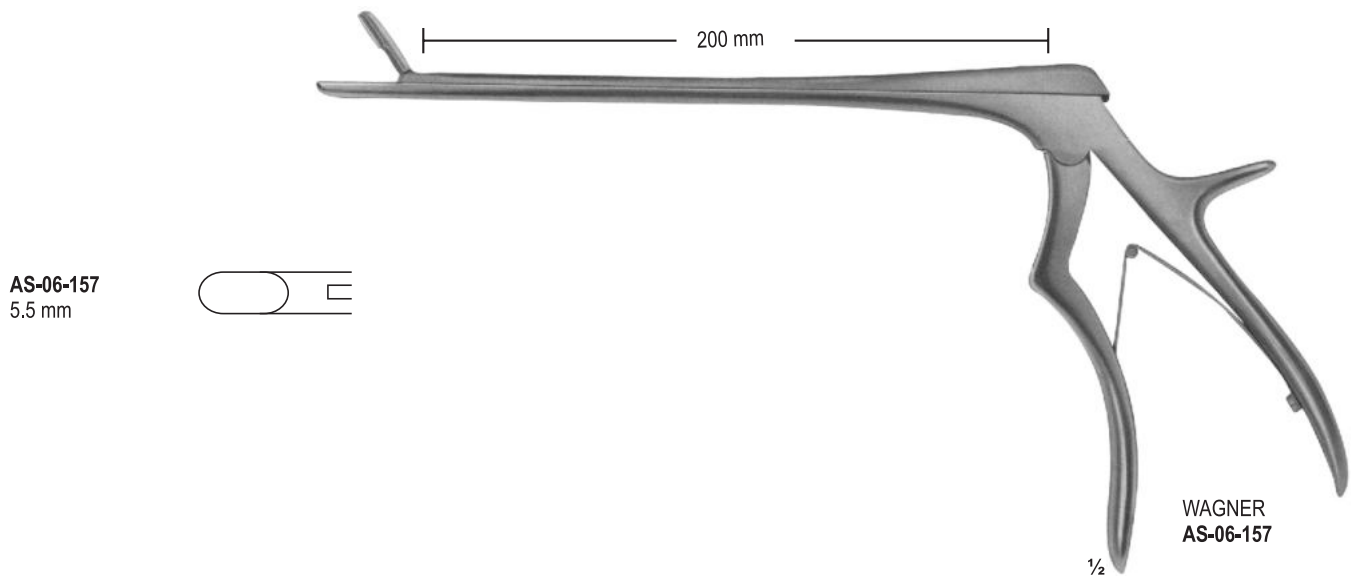
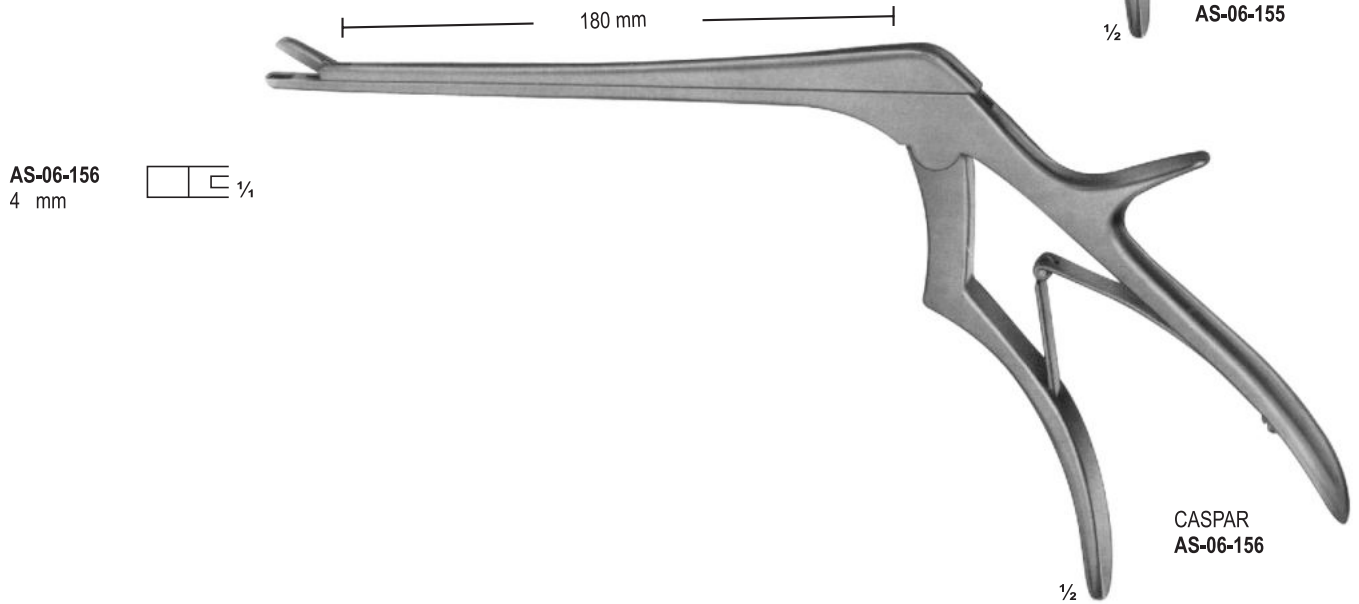
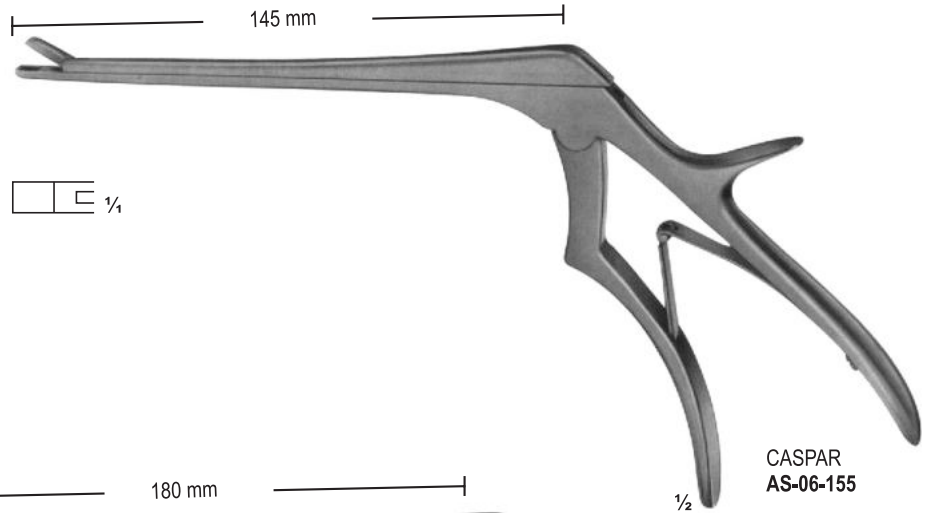

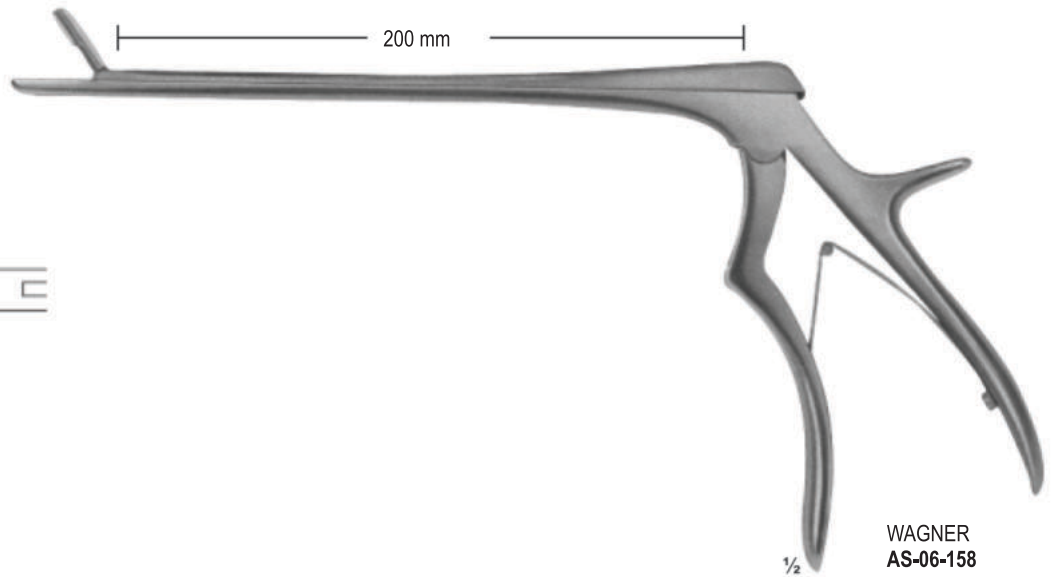

AS-06-158
5.5 mm



WAGNER
AS-06-158



AS-06-159 CHARRIER
 Length of blade
 215 mm
 complete with one saw
 blade each
 350 mm
 Spare saw blades, carbon steel
AS-06-160 12 mm
AS-06-161 20 mm

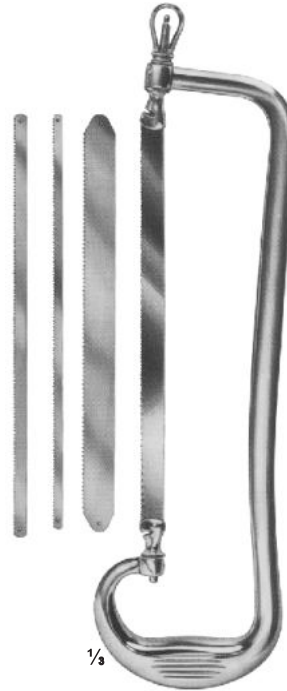

AS-06-162 RUST
 Length of blade
 235 mm
 complete with one saw
 blade each
 390 mm
AS-06-163 Bow only
 Spare saw blades, carbon steel
AS-06-164 6 mm
AS-06-165 12 mm
AS-06-166 20 mm

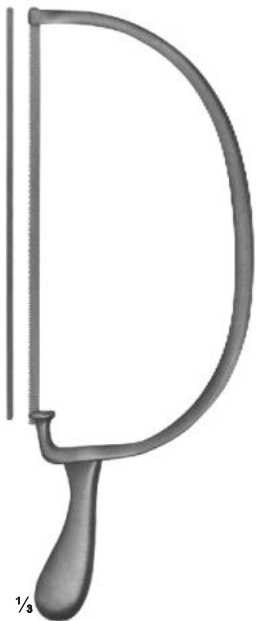

AS-06-167 BIER
 Length of blade
 270 mm
 complete with one saw
 blade each
 420 mm
 Spare saw blades, carbon steel
AS-06-168 4 mm
AS-06-169 6 mm
AS-06-170 8 mm



AS-06-171 CHARRIER
 Length of blade
 180 mm
 Spare saw blades,
 carbon steel
 270 mm
AS-06-172 CHARRIER
 Length of blade
 240 mm
 Spare saw blades,
 carbon steel
 340 mm



AS-06-173 SATTERLEE
 Length of blade
 200 mm
 Spare saw blades,
 carbon steel
 290 mm



AS-06-174 LANGENBECK
 Length of blade
 115 mm
 Metacarpal
 saw 235 mm

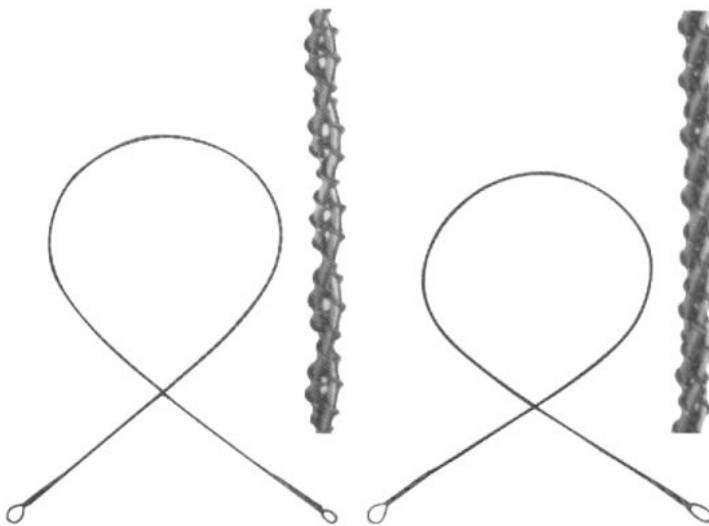

OLIVECRONA
AS-06-175 300 mm
AS-06-176 400 mm
AS-06-177 500 mm
AS-06-178 700 mm

GIGLI
AS-06-179 300 mm
AS-06-180 400 mm
AS-06-181 500 mm
 fine, 6 wires twisted
AS-06-182
 coarses, 4 wires
 twisted



AS-06-183
 GIGLI Handle



AS-06-184
 LEBSCH
 Conductor for
 wire saws,
 malleable 250 mm



CRUTCHFIELD
AS-06-185
Small Pattern



CRUTCHFIELD
AS-06-186
Medium
Pattern



AS-06-187
Large Pattern
and Spare Pin



AS-06-188
70 mm Drill
Point



AS-06-189
70 mm Drill
Point



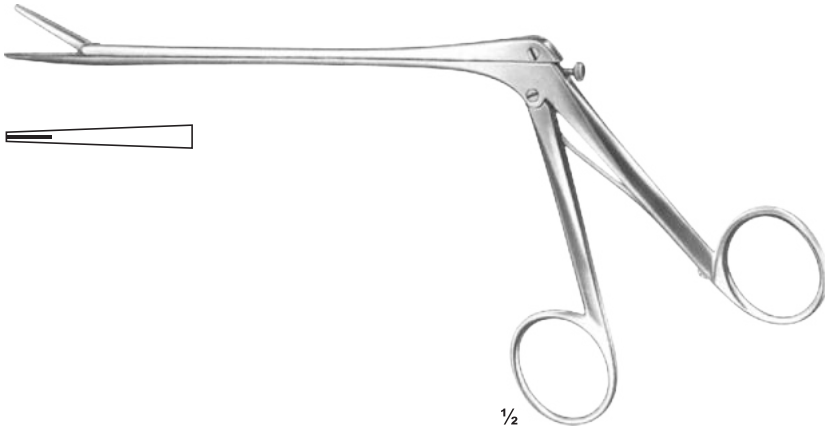

1/2

OLIVECRONA-TOENNIS
AS-06-193
Clip Applying Forceps

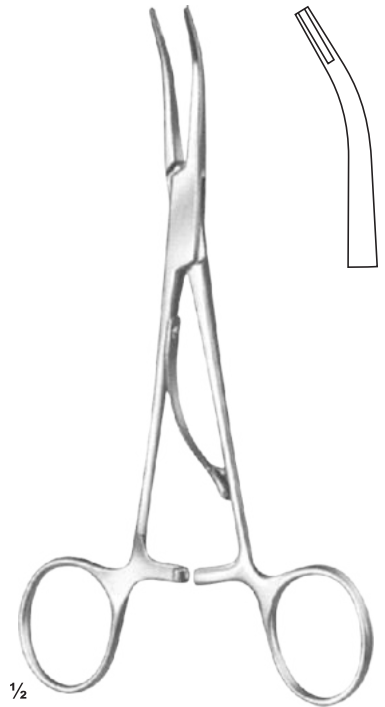

1/2

MCKENZIE
AS-06-194
185 mm
Clip Applying
Forceps



1/4

KÖLNER
AS-06-195
Scalp Clip



1/4

RANEY
AS-06-196
Scalp Clip



1/2

RANEY
AS-06-197
155 mm
Applying/Removal
Forceps



STILLE
AS-06-198 - AS-06-209
complete
20 cm



AS-06-198
2.5 mm



AS-06-199
3.0 mm



AS-06-200
3.5 mm



AS-06-201
4.0 mm



AS-06-202
10.0 mm



AS-06-203
5.0 mm



AS-06-204
8.0 mm



AS-06-205
12.0 mm



AS-06-206
16.0 mm



AS-06-207
1.0 mm



AS-06-208
1.5 mm



AS-06-209
2.0 mm



STILLE-SHERMAN
AS-06-210 - AS-06-212
complete
24 cm



AS-06-210
2.5 mm



AS-06-211
3.0 mm



AS-06-212
3.5 mm



MOORE
AS-06-213
complete 28
cm



Set of 3

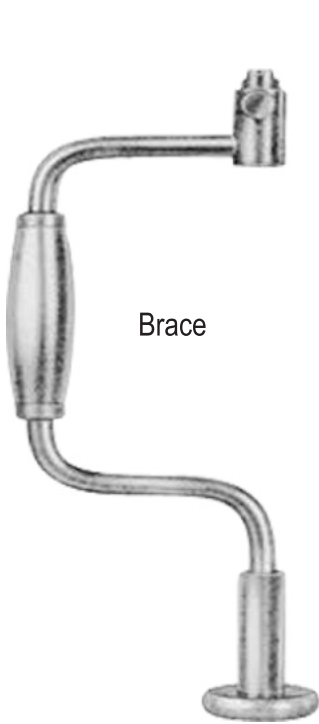

Brace

HUDSON
AS-06-214 - AS-06-223
Complete Set
27 cm



AS-06-214
9 mm



AS-06-215
14 mm



AS-06-216
16 mm



AS-06-217
22 mm



AS-06-218
14 mm



AS-06-219
Extension
Piece



AS-06-220
Mckenzie
15 mm



AS-06-221
Mckenzie
2.0 mm



AS-06-222
Mckenzie
1.3 mm



AS-06-223
Derrico
1.6 mm



KIRSCHNER
AS-06-224
Complete



Telescope Wire
Dill Guide



AS-06-225
Complete



Telescope Wire
Dill Guide

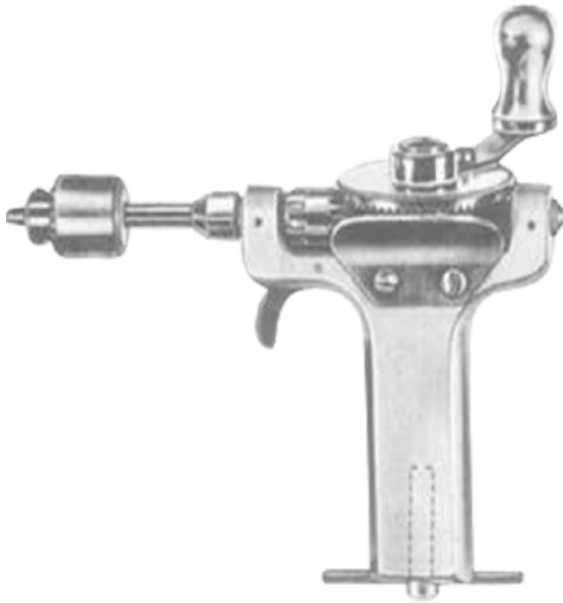

BUNNELL
AS-06-226



ROLK
AS-06-227



AS-06-228
Drilling chuck, cannulated,
for shanks up to 6.35 mm
diam., To be tightened by hand
10 cm



AS-06-229
Drilling chuck, cannulated,
for shanks up to 6.35 mm
diam., With key
16 cm

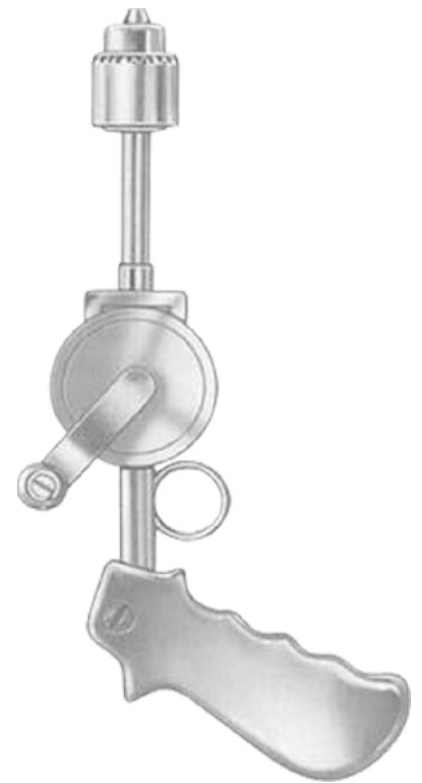

AS-06-230



ASAMAR
SURGICAL 

PAGE
131-147
DISSECTING
&TISSUE FORCEPS

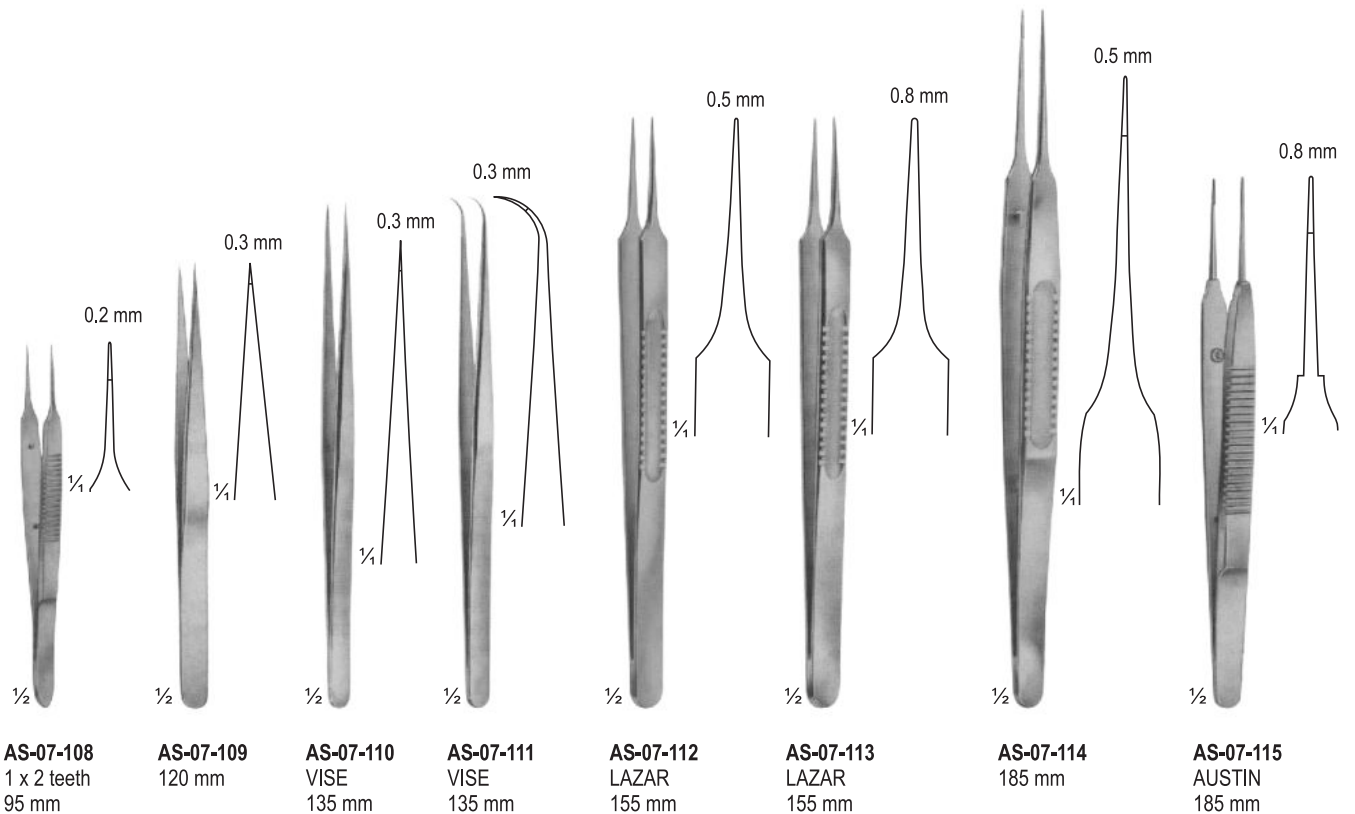
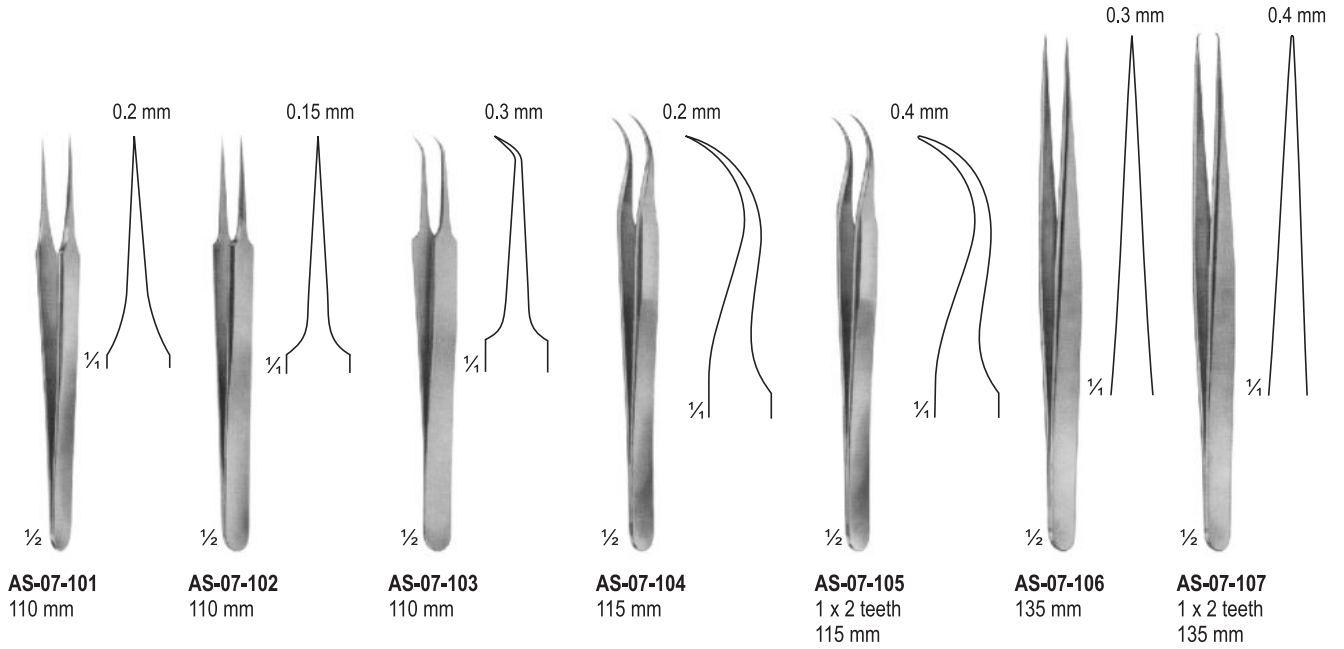

LIGATURE FORCEPS, MICRO FORCEPS (LIGHT PATTERNS)

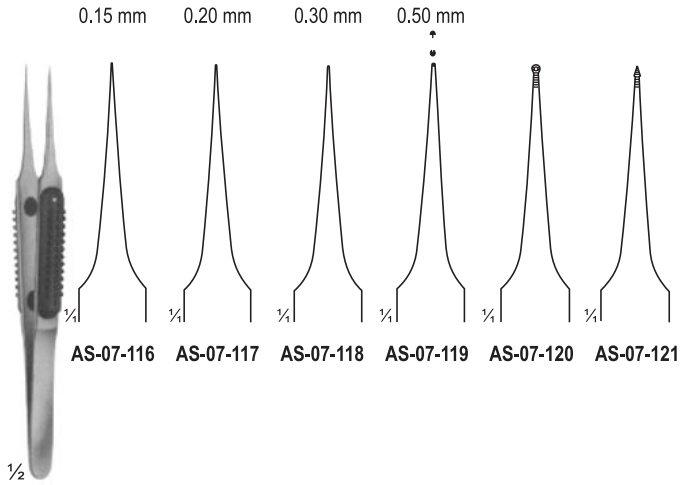

AS-07-116 - AS-07-121
MULLER
110 mm

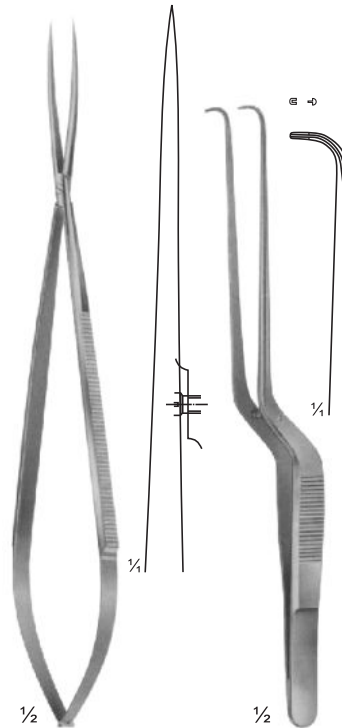

AS-07-122
LIGATURE FORCEPS
220 mm

AS-07-123
YASARGIL
185 mm

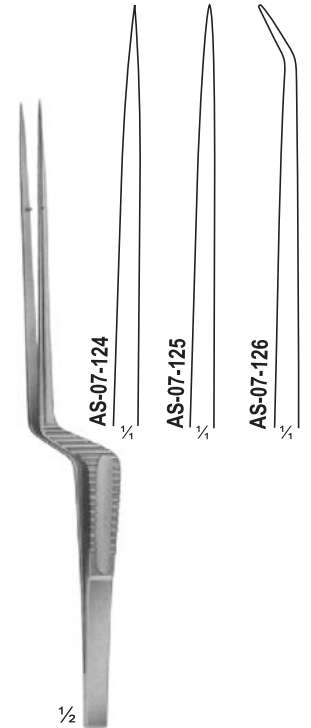

AS-07-124 - AS-07-126
MICRO FORCEPS
185 mm

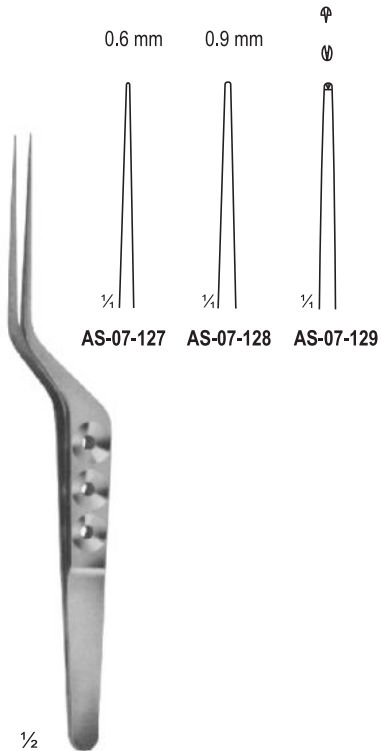

AS-07-127 - AS-07-129
YASARGIL
180 mm

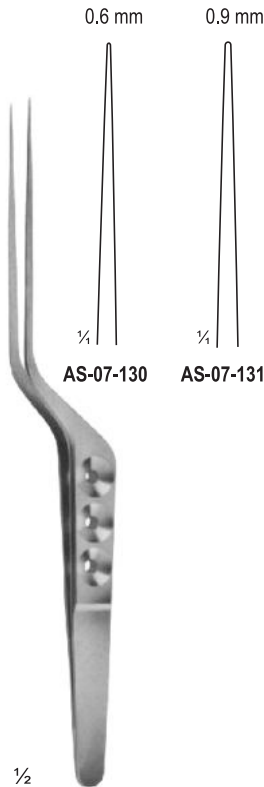

AS-07-130 - AS-07-131
YASARGIL
200 mm



AS-07-132 - AS-07-133
YASARGIL
220 mm

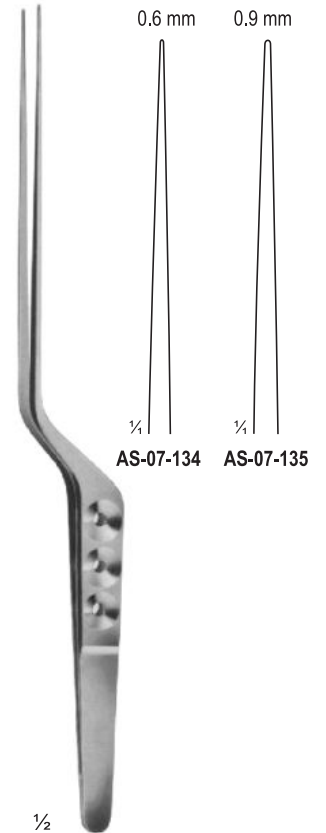

AS-07-134 - AS-07-135
YASARGIL
240 mm

FORCEPS FOR GRASPING TISSUE AND TUMORS

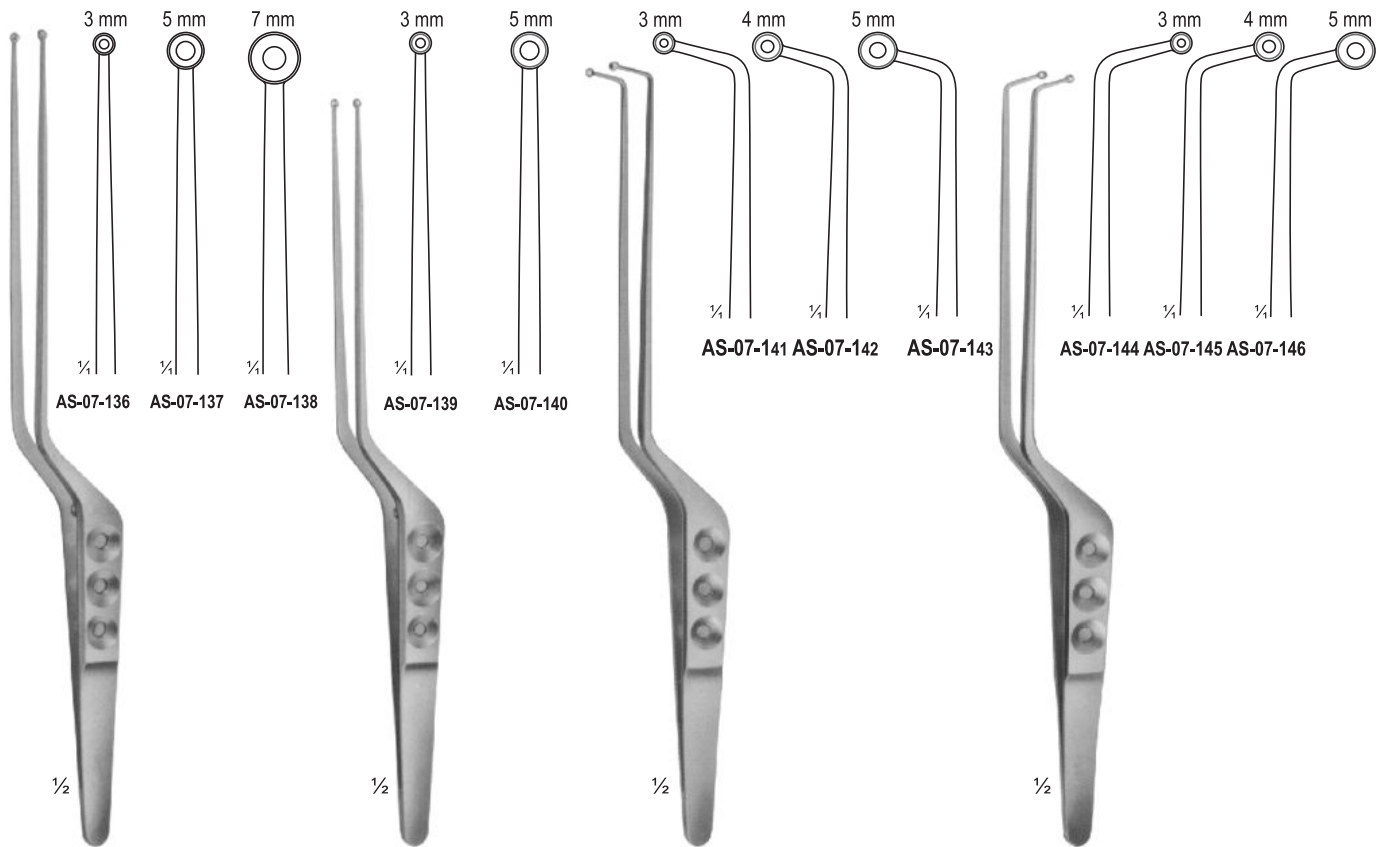

AS-07-136 - AS-07-138
YASARGIL-SAMII
Jaws Spoon-Shaped
240 mm

AS-07-139 - AS-07-140
YASARGIL
Jaws Spoon-Shaped
220 mm

AS-07-141 - CD-043
SAMII
Jaws Spoon-Shaped
230 mm

AS-07-144 - AS-07-146
SAMII
Jaws Spoon-Shaped
230 mm

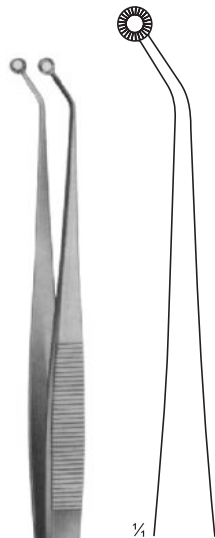

AS-07-147
HUNT $\frac{1}{2}$
Tumor-and Vessel
Forceps 200 mm

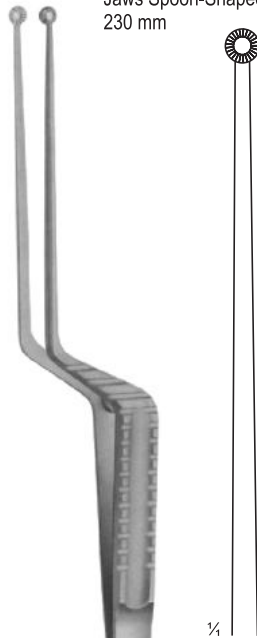

AS-07-148
HUNT $\frac{1}{2}$
Tumor-and Vessel
Forceps 200 mm

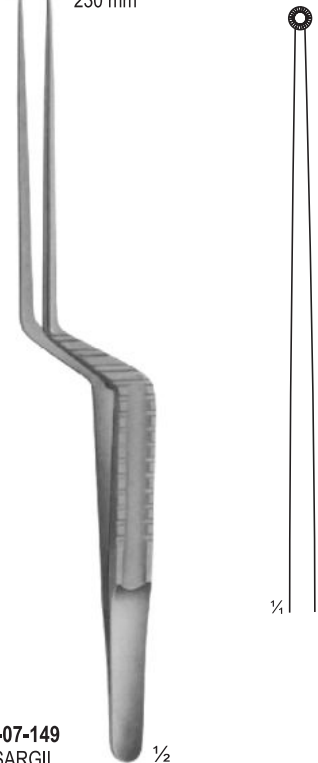

AS-07-149
YASARGIL $\frac{1}{2}$
Tumor-and Vessel
Forceps 200 mm

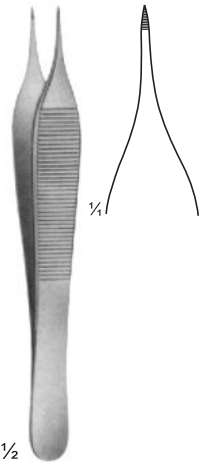

AS-07-150
THORPE
Corneal
Forceps 120
mm

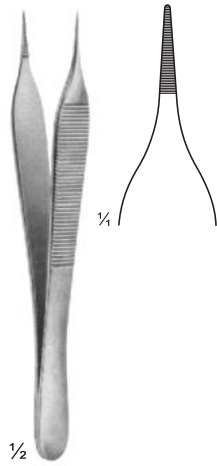

AS-07-151
MICRO-ADSON
120 mm

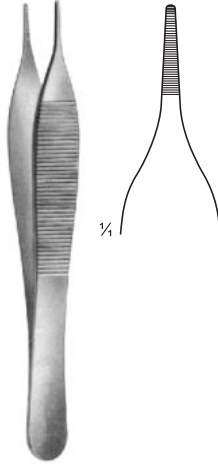

AS-07-152
ADSON
120 mm

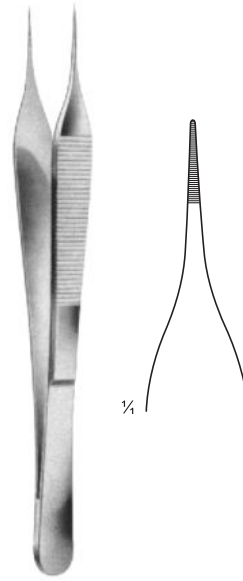

AS-07-153
MICRO-ADSON
150 mm

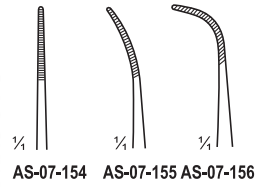

AS-07-154 - AS-07-156
100 mm

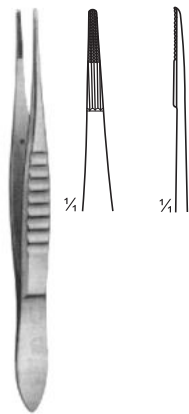

AS-07-157
110 mm

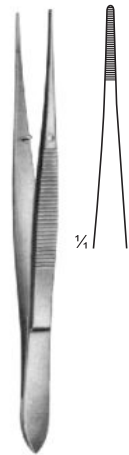

AS-07-158
115 mm



AS-07-159 - AS-07-168

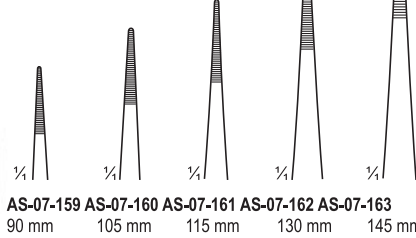

AS-07-159 90 mm
AS-07-160 105 mm
AS-07-161 115 mm
AS-07-162 130 mm
AS-07-163 145 mm

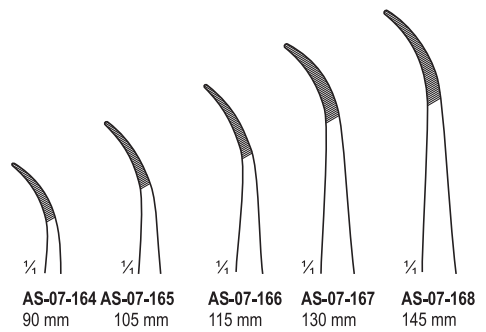

AS-07-164 90 mm
AS-07-165 105 mm
AS-07-166 115 mm
AS-07-167 130 mm
AS-07-168 145 mm

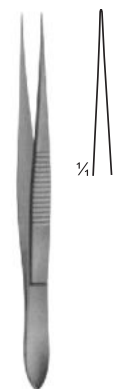

AS-07-169
100 mm

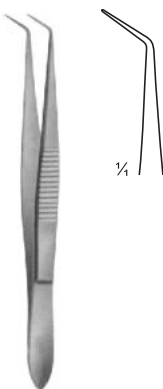

AS-07-170
100 mm

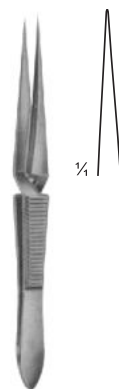

AS-07-171
100 mm

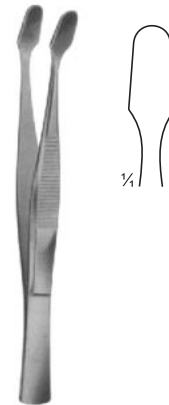

AS-07-172
COVER GLASS FORCEPS
105 mm



AS-07-173
160 mm

DELICATE DISSECTING FORCEPS

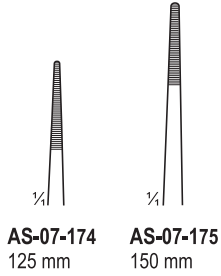

1/2
AS-07-174 - AS-07-175
SEMKEN

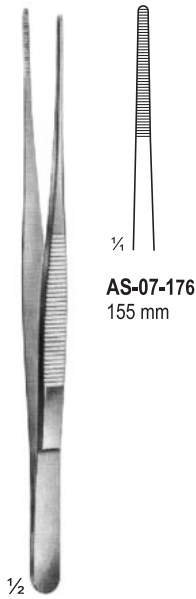

AS-07-176



AS-07-177
MC INDOE

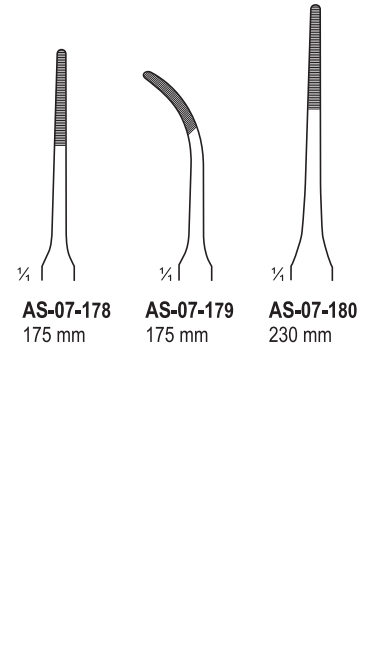

AS-07-178 - AS-07-180
GERALD

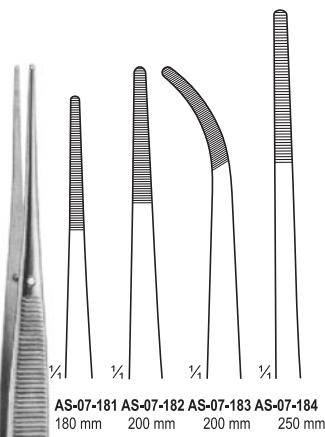

AS-07-181 - AS-07-184
CUSHING

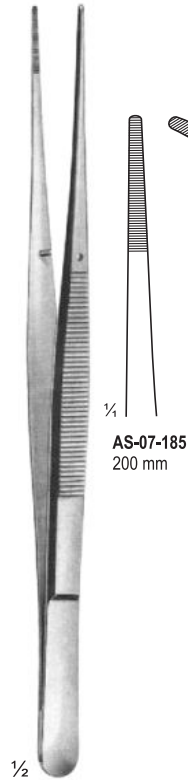

AS-07-185 - AS-07-186
BROPHY

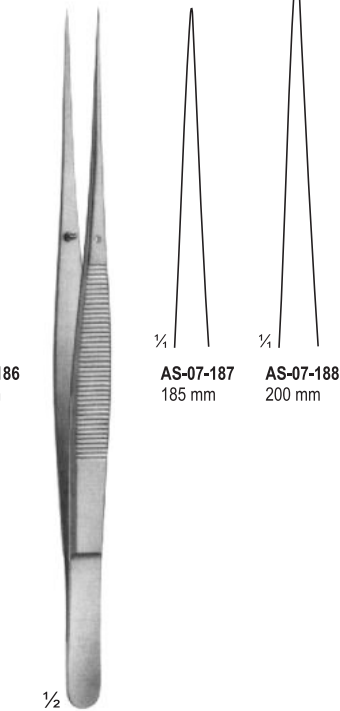
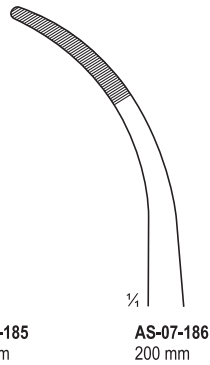

AS-07-187 - AS-07-188
SMOOTH JAWS

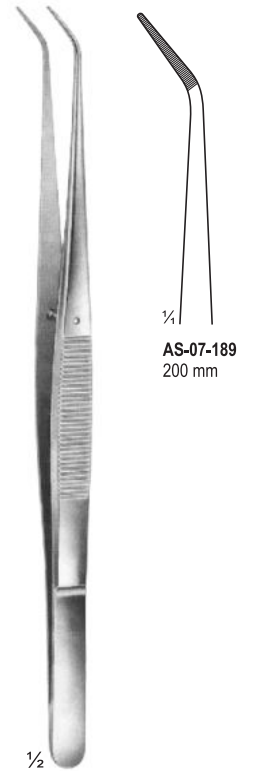

AS-07-189

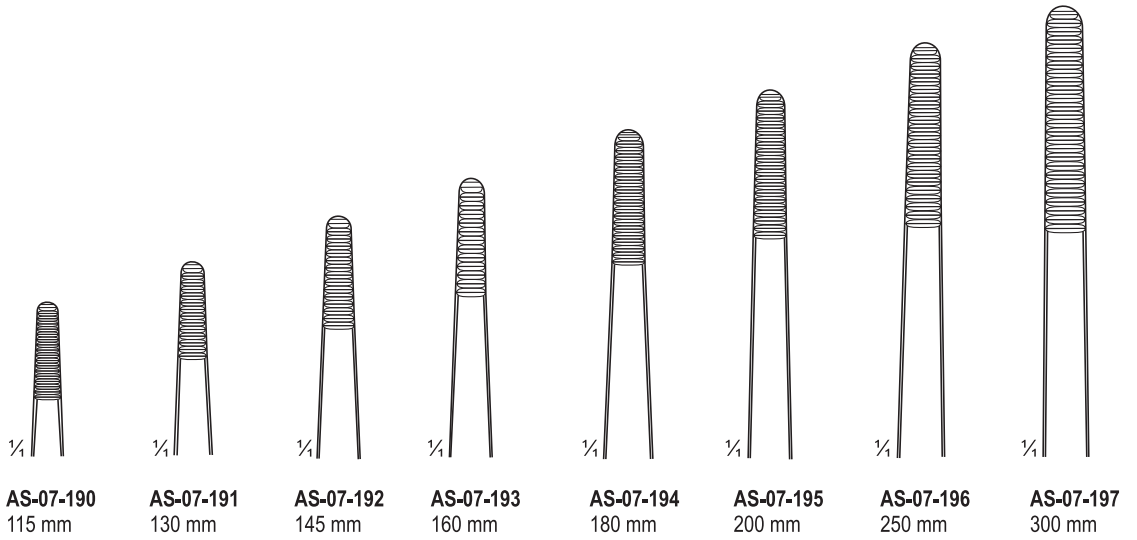

AS-07-190 - AS-07-197
STANDARD

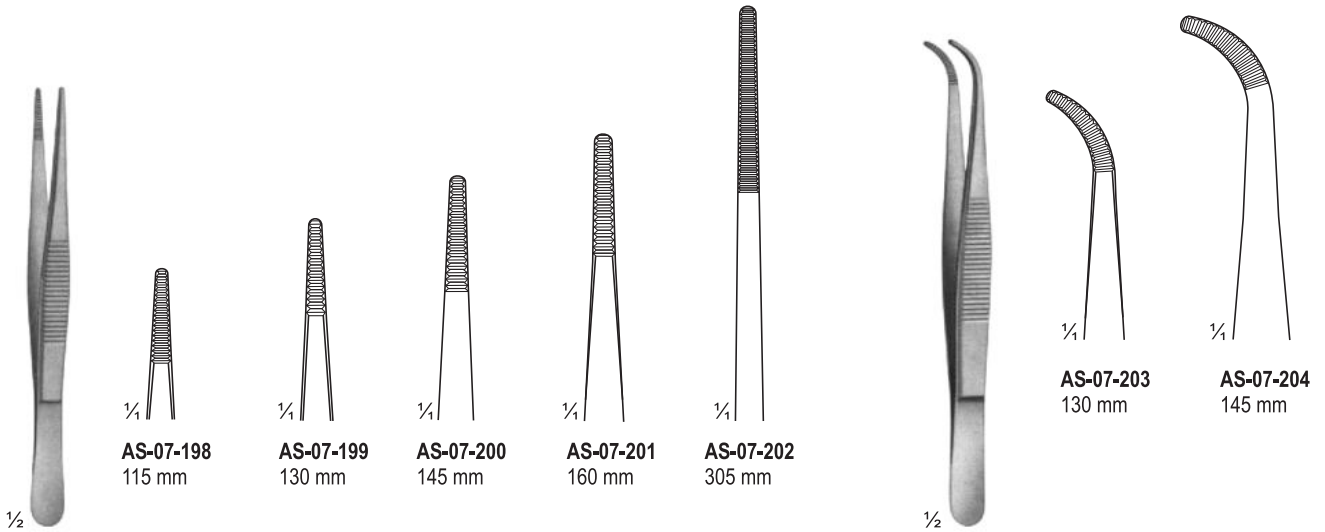

AS-07-198 - CD-102
MEDIUM

AS-07-203 - AS-07-204
MEDIUM

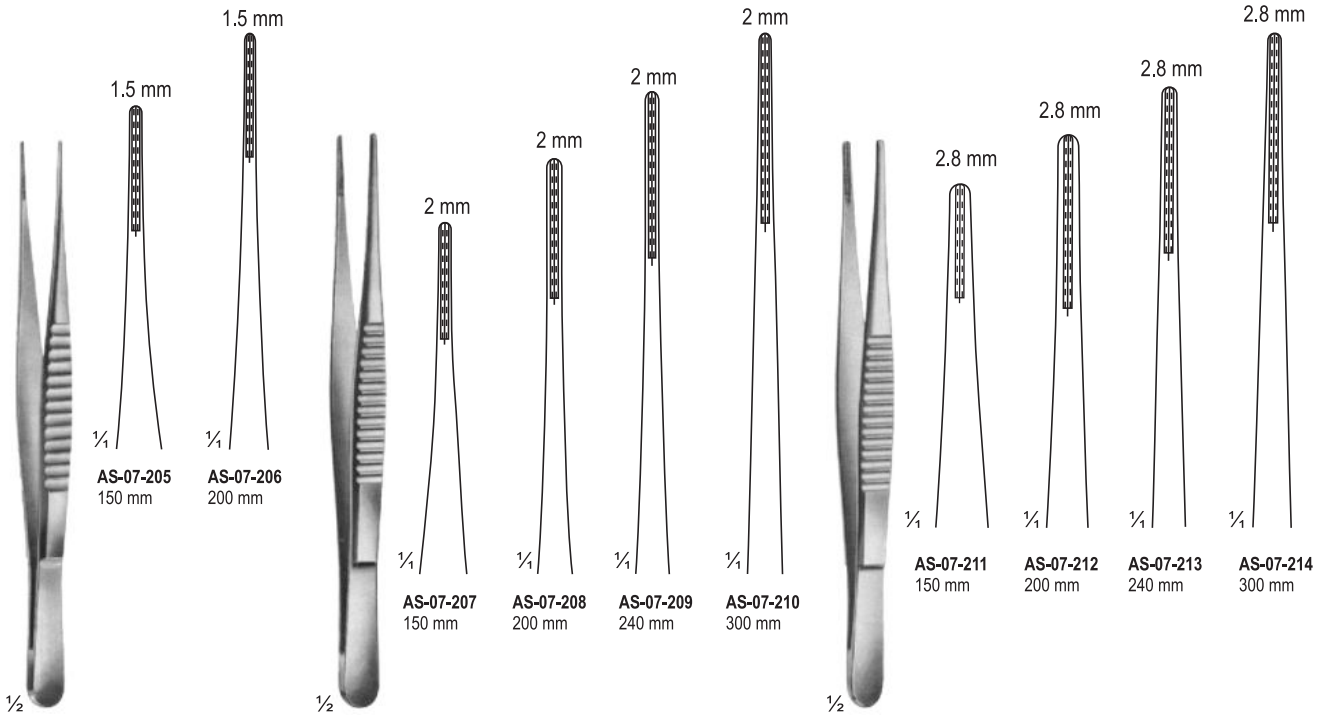

AS-07-205 - AS-07-206
DE BAKEY

AS-07-207 - AS-07-210
DE BAKEY

AS-07-211 - AS-07-214
DE BAKEY

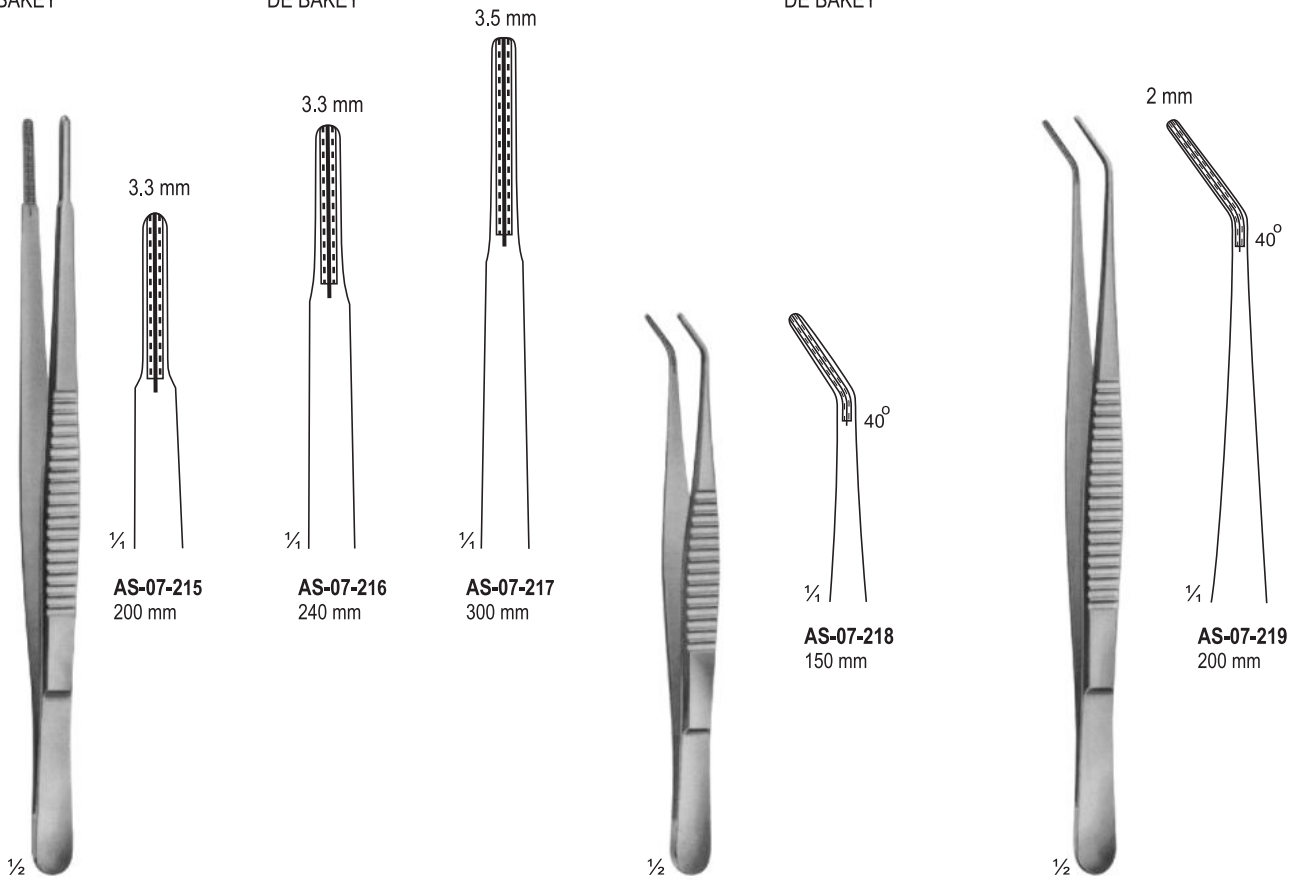

AS-07-215 - AS-07-217
DE BAKEY

AS-07-218
DE BAKEY

AS-07-219
DE BAKEY

FORCEPS, BAYONET - SHAPED



ASAMAR
SURGICAL

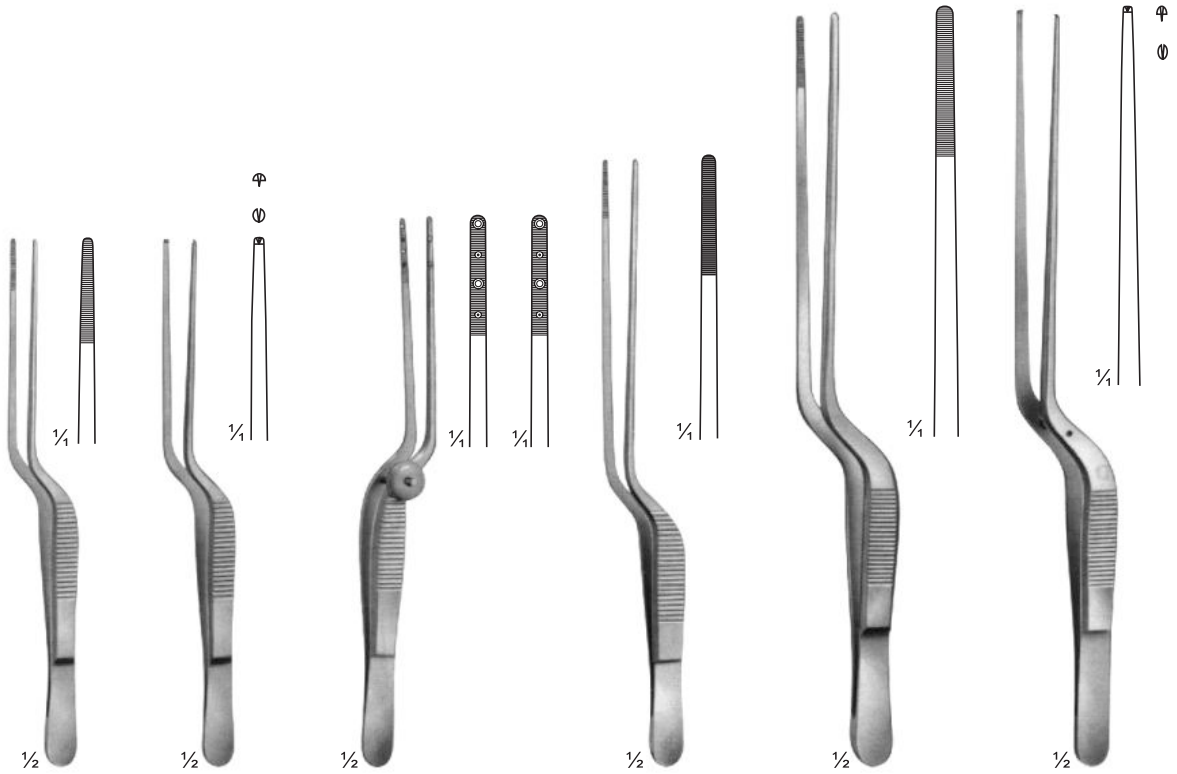

AS-07-220
LUCAE 140
mm

AS-07-221
LUCAE

AS-07-222
COTTLE
Forceps with
jaws toothed
and serrated
140 mm

AS-07-223
JANSEN
160 mm

AS-07-224
GRUENWALD
200 mm

AS-07-225
1x2 teeth
200 mm

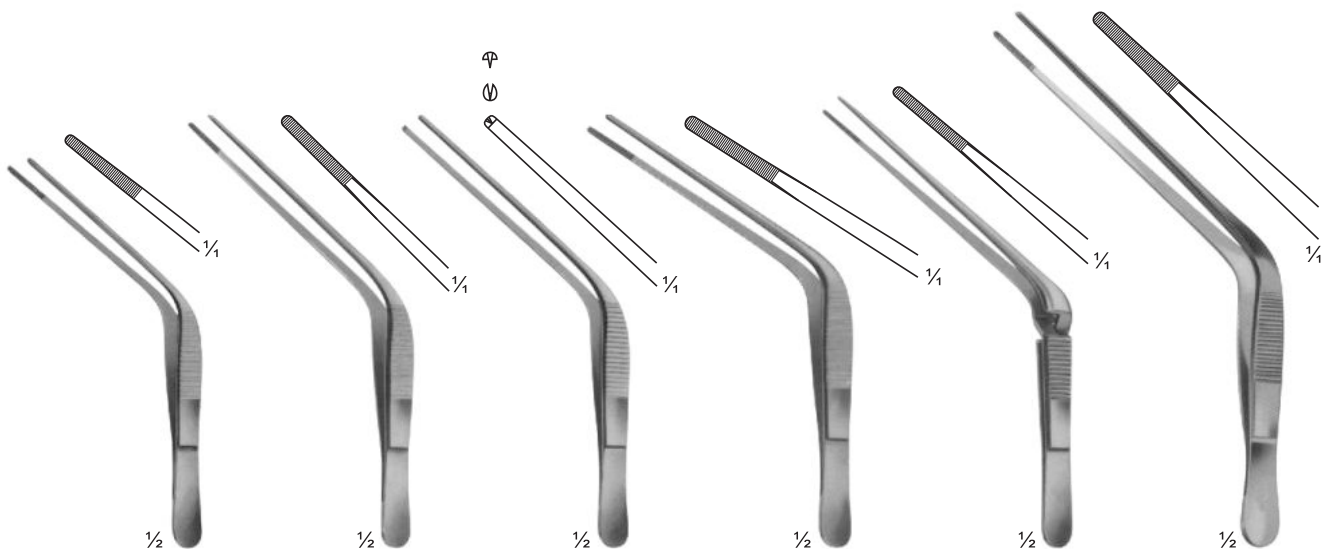

AS-07-226
TROELTSCH
100 mm

AS-07-227
TROELTSCH
115 mm

AS-07-228
TROELTSCH
1X2 teeth
115 mm

AS-07-229
WILDE 115
mm

AS-07-230
TROELTSCH
Cross action
120 mm

AS-07-231
TROELTSCH
140 mm

DELICATE TISSUE FORCEPS



1/2
AS-07-232
BISHOP-HARMON
85 mm

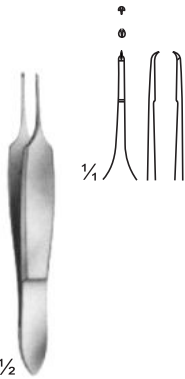

1/2
AS-07-233
ST.MARTIN
80 mm

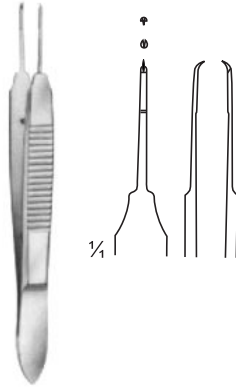

1/2
AS-07-234
CASTROVIEJO
teeth 0.9 mm
100 mm

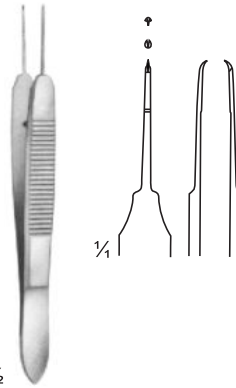

1/2
AS-07-235
CASTROVIEJO
teeth 0.5 mm
100 mm

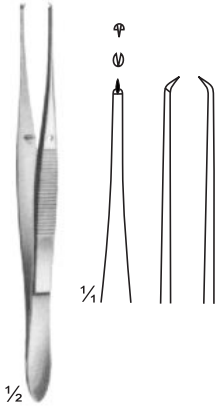

1/2
AS-07-236
ELSCHING
110 mm



1/2
AS-07-237
GILL
75 mm

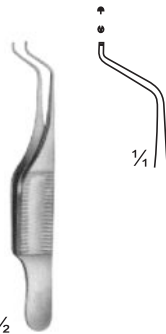

1/2
AS-07-238
GILL - HESS
75 mm

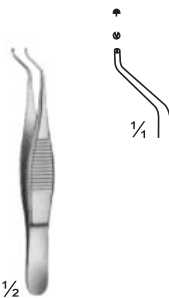

1/2
AS-07-239
HESS
70 mm

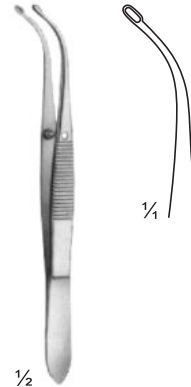

1/2
AS-07-240
ARRUGA
100 mm

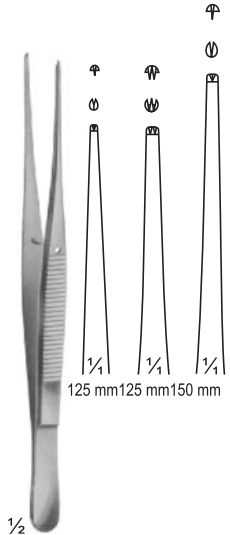

1/2
AS-07-241
SEMKEN
125 mm 125 mm 150 mm

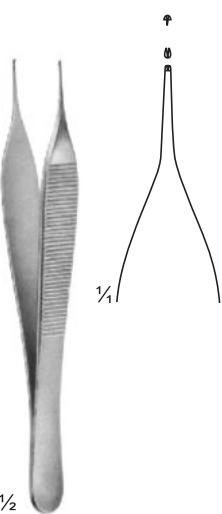

1/2
AS-07-242
MICRO-ADSON
120 mm

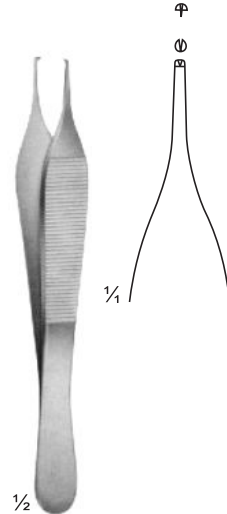

1/2
AS-07-243
ADSON
120 mm

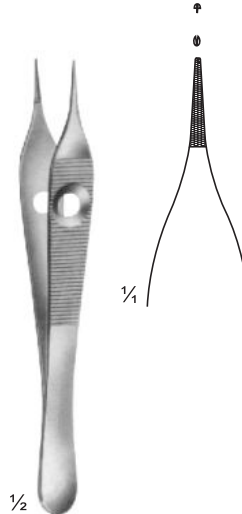

1/2
AS-07-244
ADSON
120 mm



1/2
AS-07-245
ADSON
120 mm

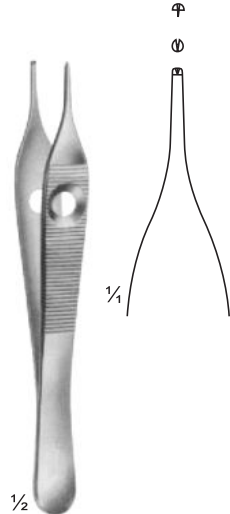

1/2
AS-07-246
ADSON
150 mm

LIGATURE FORCEPS, MICRO FORCEPS (LIGHT PATTERNS)



ASAMAR
SURGICAL

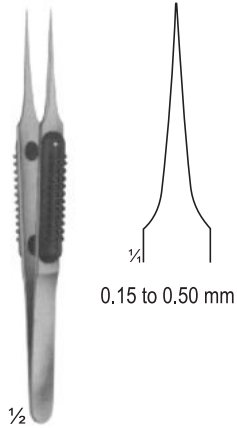

0.15 to 0.50 mm

MULLER AS-07-247
110 mm 0.15 mm
AS-07-248
110 mm 0.20 mm
AS-07-249
110 mm 0.30 mm
AS-07-250
110 mm 0.50 mm
AS-07-251

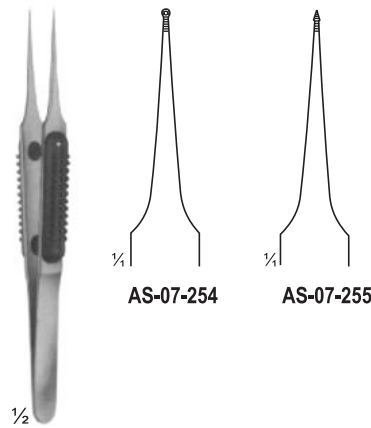

AS-07-254 **AS-07-255**

MULLER AS-07-252
110 mm
AS-07-253
110 mm

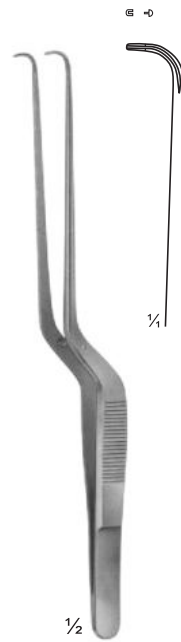

YASARGIL AS-07-256
185 mm



YASARGIL AS-07-257
180 mm
AS-07-258
200 mm
AS-07-259
220 mm
AS-07-260
240 mm

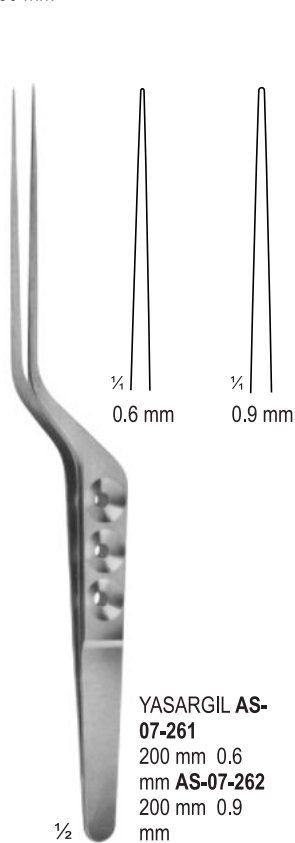

YASARGIL AS-07-261
200 mm 0.6 mm
AS-07-262
200 mm 0.9 mm

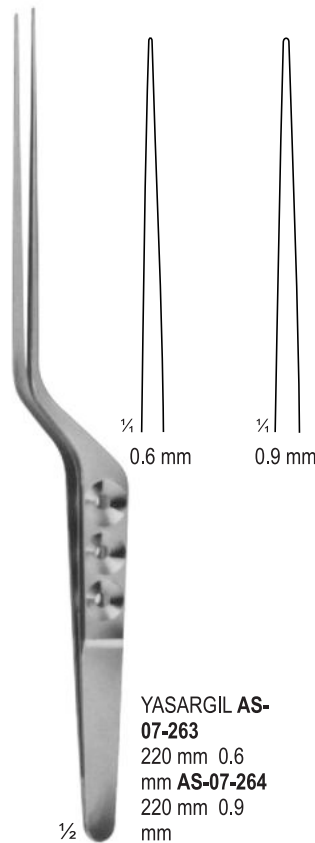

YASARGIL AS-07-263
220 mm 0.6 mm
AS-07-264
220 mm 0.9 mm

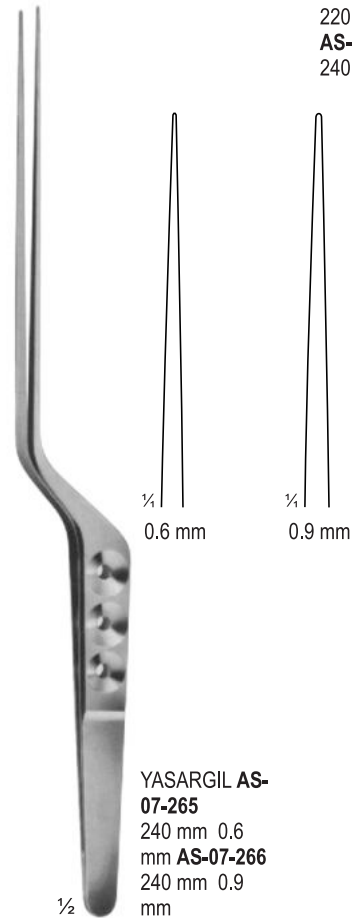

YASARGIL AS-07-265
240 mm 0.6 mm
AS-07-266
240 mm 0.9 mm

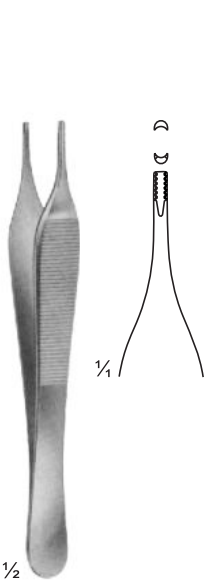

AS-07-267
ADSON - BROWN
 Non-traumatic
 120 mm

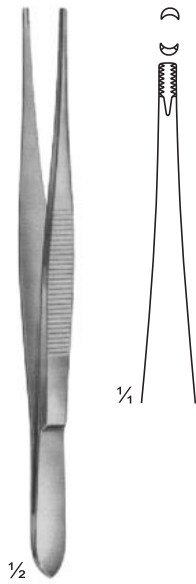

AS-07-268
BROWN
 120 mm

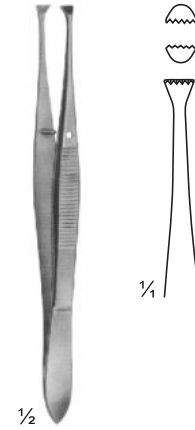

AS-07-269
GRAEFE
 110 mm

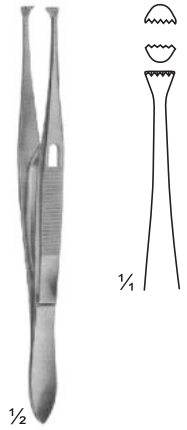

AS-07-270
GRAEFE
 With Catch
 110 mm

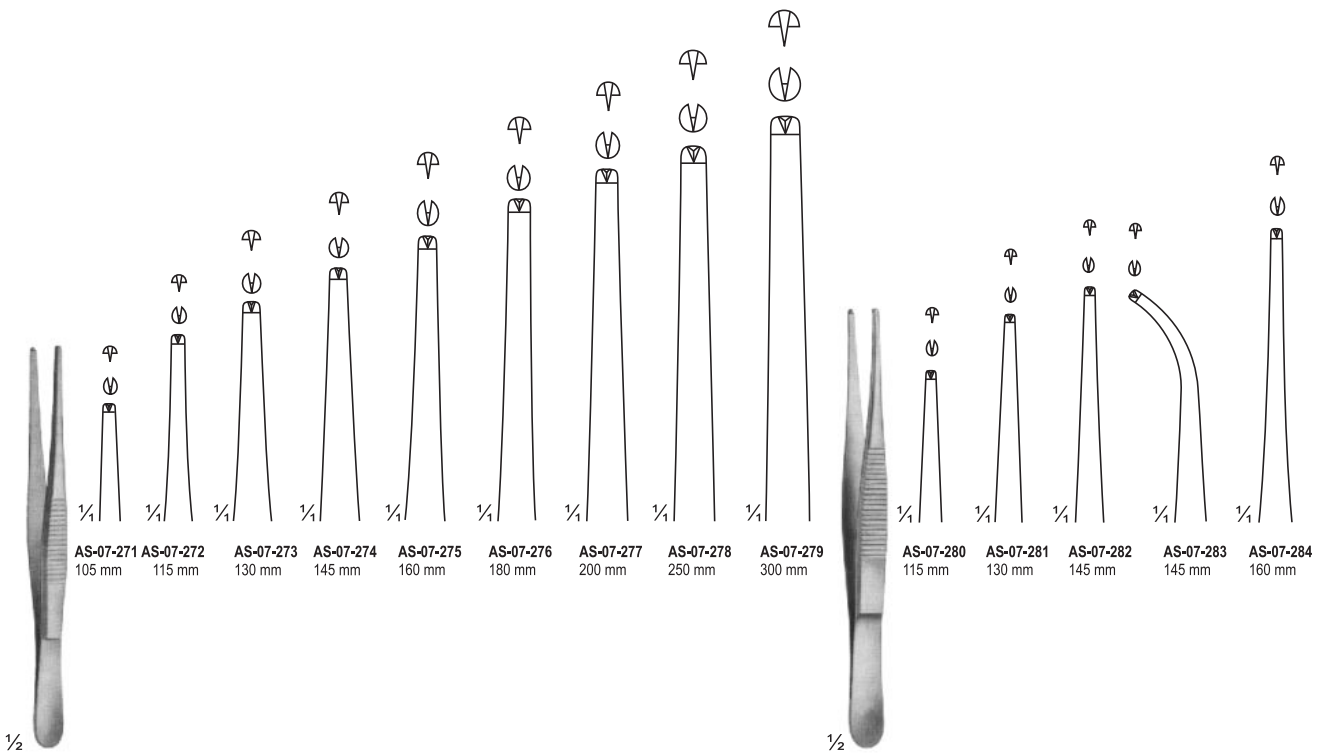

AS-07-271 - AS-07-279
STANDARD

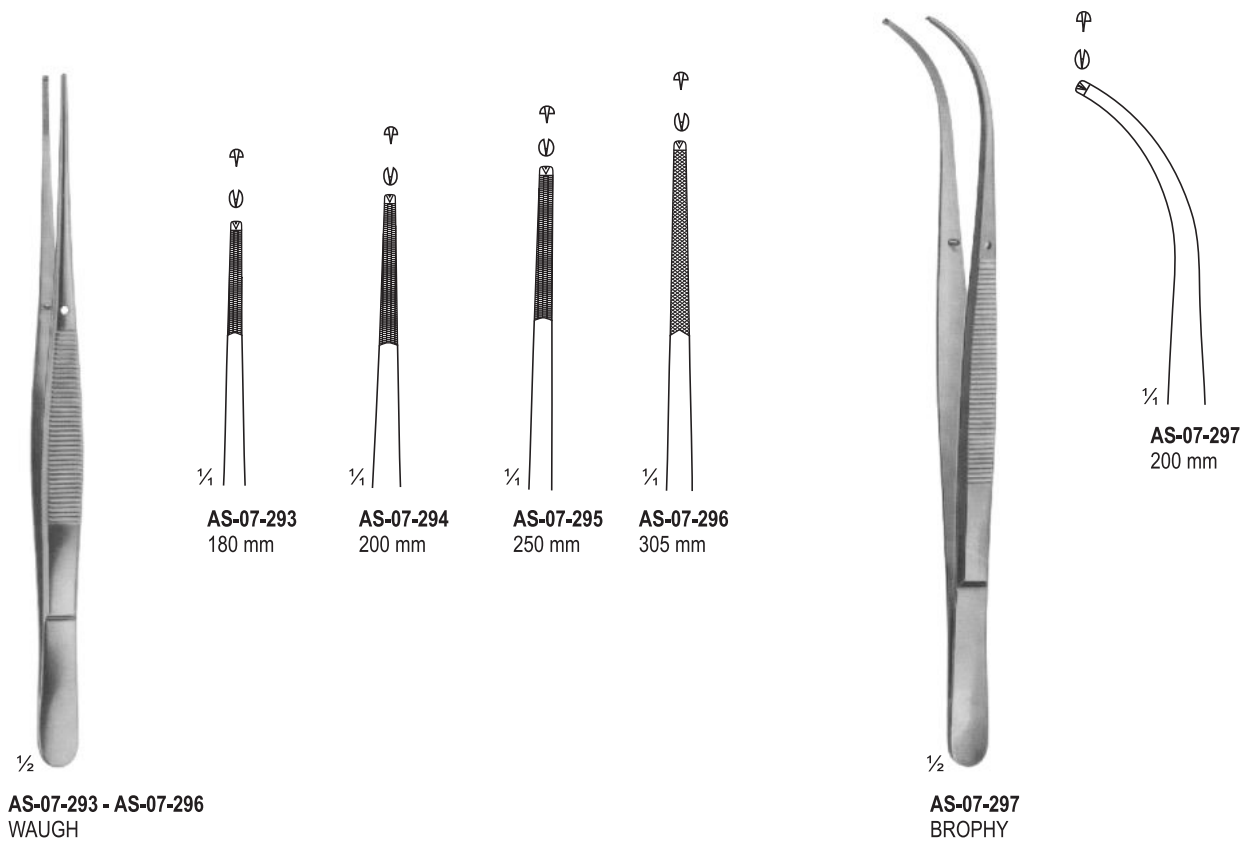
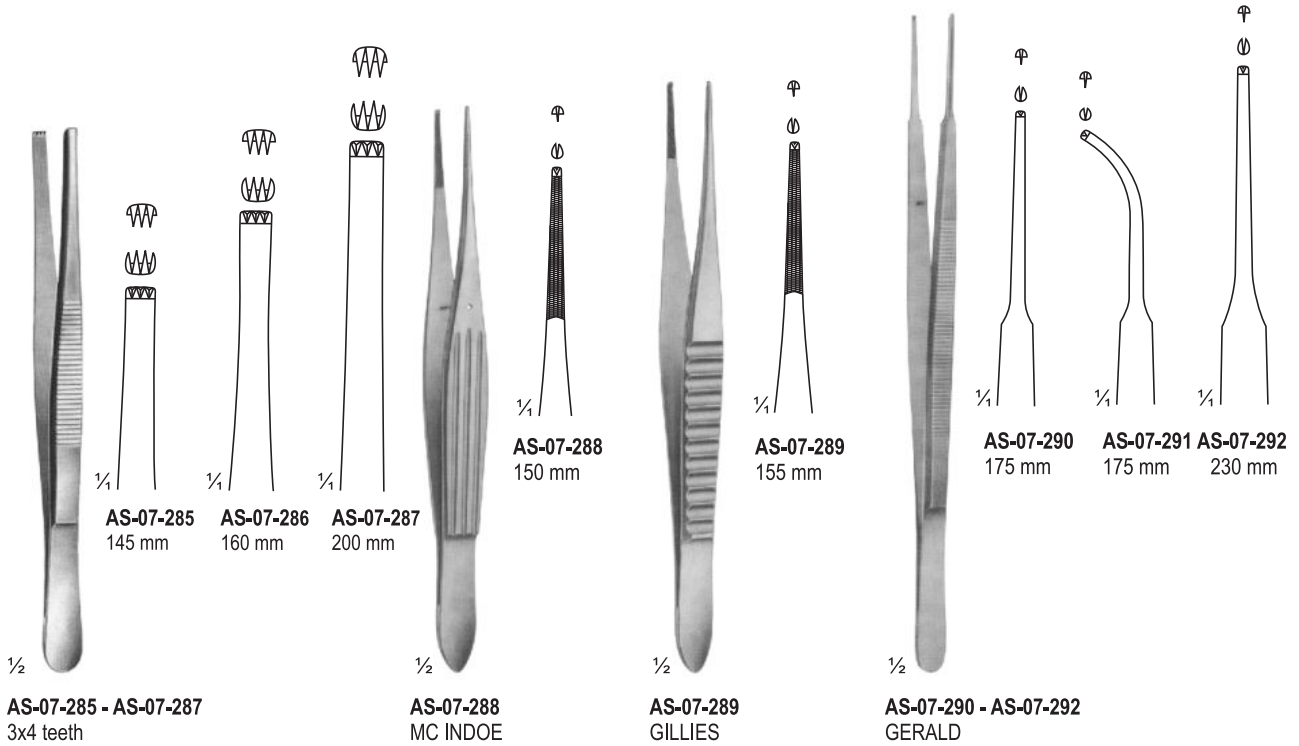

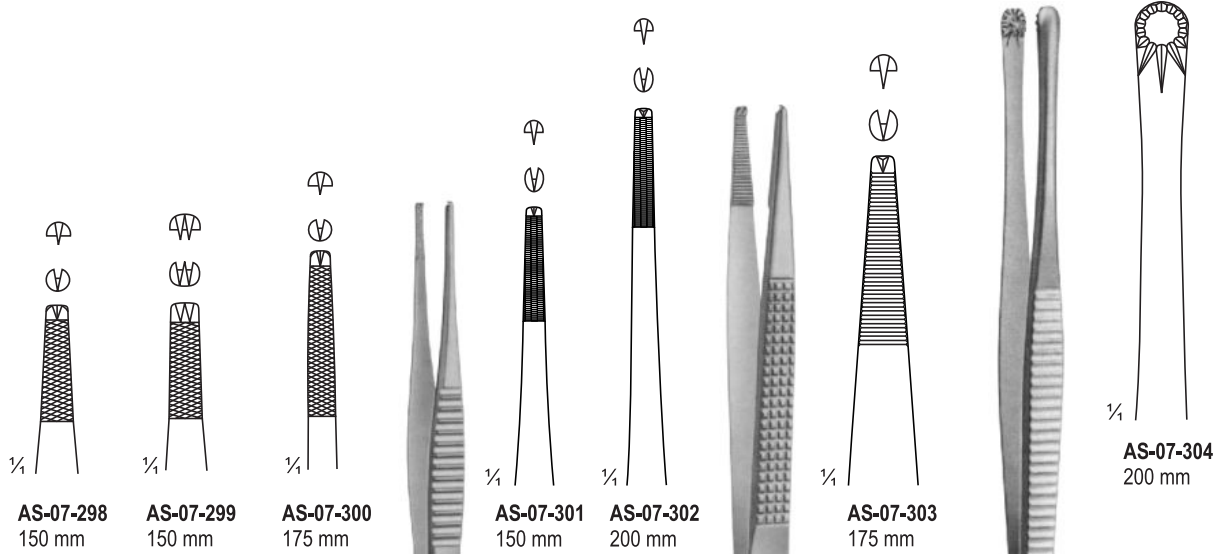

AS-07-398 - AS-07-300
LANE

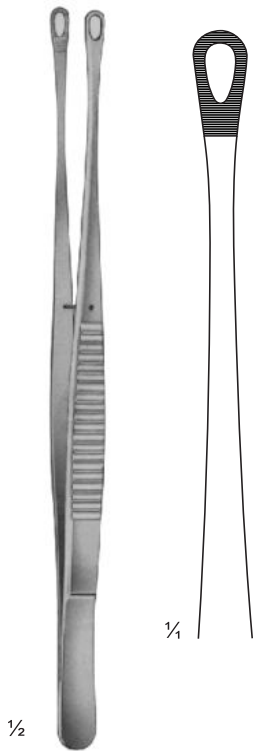

AS-07-305 TUTTLE
Lung Dissecting Forceps
230 mm

AS-07-301 - AS-07-302
STRASSBURGER
MODELL

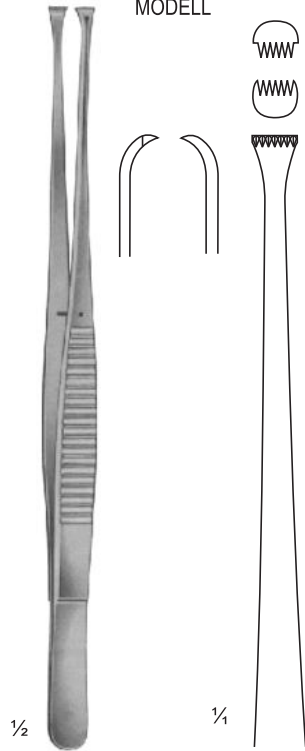

AS-07-306 NELSON
Lung Dissecting Forceps
230 mm

AS-07-303
BONNEY

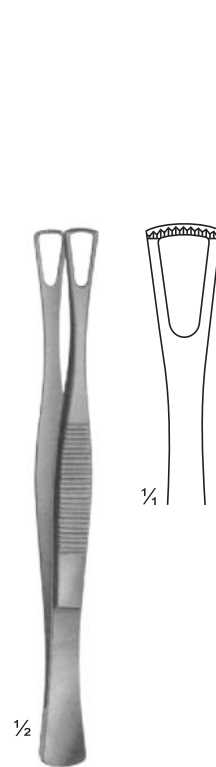

AS-07-307 DUVAL
Intestinal Forceps
140 mm

AS-07-304
RUSS.MODELL
200 mm

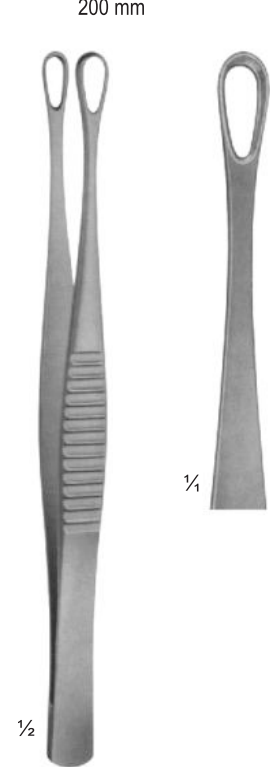

AS-07-308 DENIS-BROWNE
Intestinal Forceps 190 mm

SPLINTER AND CILIA FORCEPS

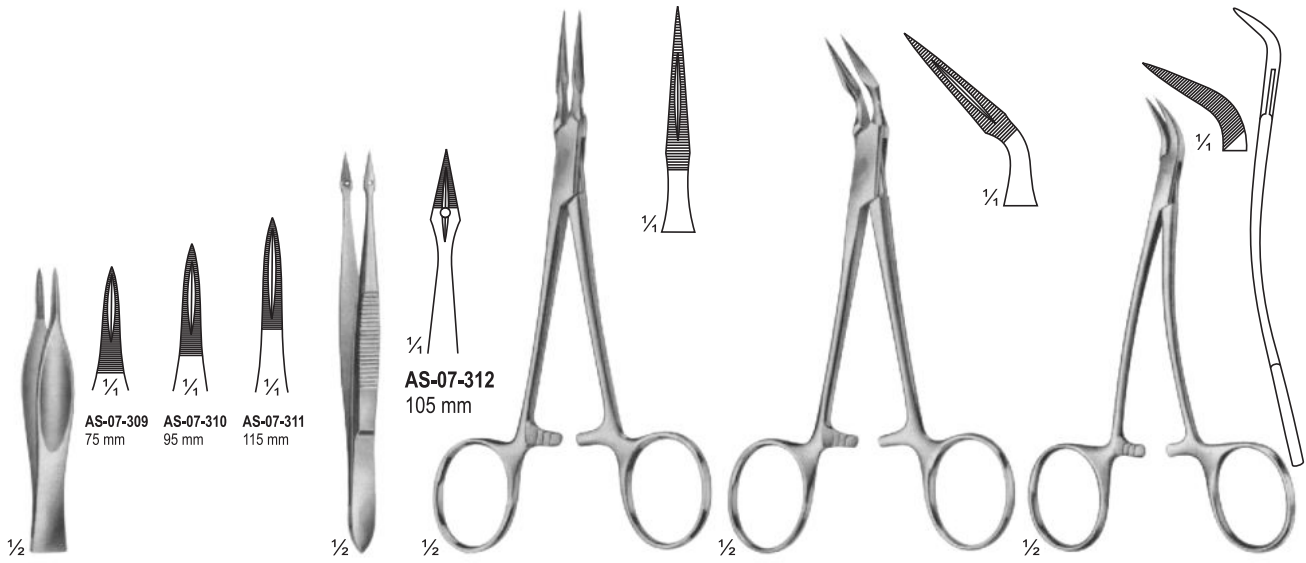

AS-07-309 - AS-07-311
FEILCHENFELD

AS-07-312
HUNTER

AS-07-313
STIEGLITZ
140 mm

AS-07-314
STIEGLITZ
140 mm

AS-07-315
PEET
120 mm

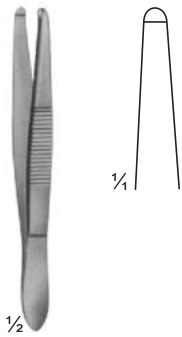

AS-07-316
BEER
85 mm

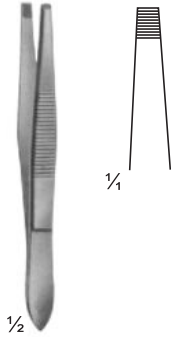

AS-07-317
85 mm

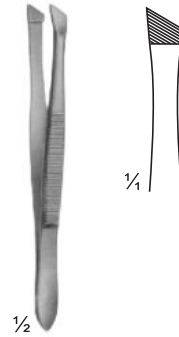

AS-07-318
85 mm

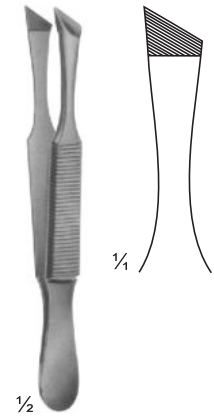

AS-07-319
105 mm

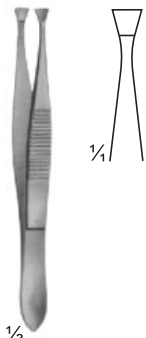

AS-07-320
105 mm

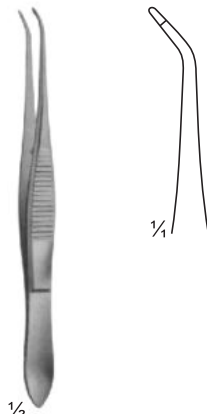

AS-07-321
SAUPE 105
mm

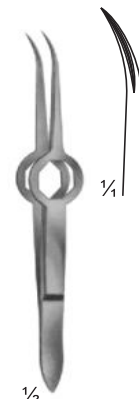

AS-07-322
SCHAAF 95
mm



AS-07-323

FORCEPS WITH TUNGSTEN CARBIDE INSERTS



ASAMAR
SURGICAL



STANDARD

- AS-07-324** 14.5 cm, 5 3/4"
- AS-07-325** 16.0 cm, 6 1/4"
- AS-07-326** 18.0 cm, 7"
- AS-07-327** 20.0 cm, 8"
- AS-07-328** 25.0 cm, 10"
- AS-07-329** 30.0 cm, 12"

STANDARD

- AS-07-330** 14.5 cm, 5 3/4"
- AS-07-331** 16.0 cm, 6 1/4"
- AS-07-332** 18.0 cm, 7"
- AS-07-333** 20.0 cm, 8"
- AS-07-334** 25.0 cm, 10"
- AS-07-335** 30.0 cm, 12"

STANDARD

- AS-07-336** 12.5 cm, 5"
- AS-07-337** 15.0 cm, 6"

STANDARD

- AS-07-338** 15.0 cm, 6"
- AS-07-339** 23.0 cm, 9"
- AS-07-340** 25.0 cm, 10"

FORCEPS WITH TUNGSTEN CARBIDE INSERTS



ASAMAR
SURGICAL



GILLIES
AS-07-341
15.0 cm, 6"



MC INDOE
AS-07-342
15.0 cm, 6"



GERALD
AS-07-343 - AS-07-344
17.0 cm, 6 3/4"



POTTS-SMITH
AS-07-345 15.0 cm, 6"
AS-07-346 18.0 cm, 7"
AS-07-347 20.0 cm, 8"



BONNEY
AS-07-348
17.5 cm, 6 5/8"

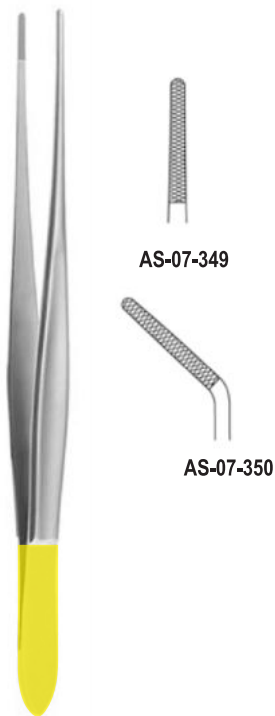

CUSHING
AS-07-349 - AS-07-350
17.5 cm, 6 5/8"



CUSHING-TAYLOR
AS-07-351
18.0 cm, 7"



ADSON
AS-07-352 - AS-07-355
17.5 cm, 6 5/8"

FORCEPS WITH TUNGSTEN CARBIDE INSERTS



ASAMAR
SURGICAL



DE BAKEY
AS-07-356
150 mm
AS-07-357
200 mm
AS-07-358
250 mm
DE BAKEY

DE BAKEY
AS-07-356 - AS-07-361



JABOMA-TC
AS-07-362
180 mm

JABOMA-TC
AS-07-363
180 mm

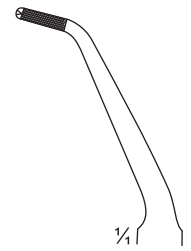

JABOMA-TC
AS-07-364
180 mm



OBWEGESER
AS-07-365
160 mm



OBWEGESER
AS-07-366
180 mm



MERIEM
AS-07-367

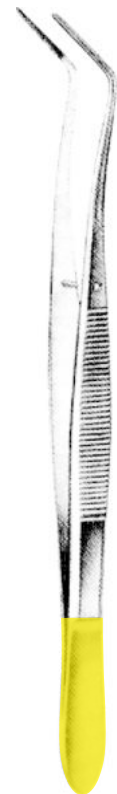

POTTS-NEVINS
AS-07-368
180 mm



ASAMAR
SURGICAL 

PAGE
162-147
DISSECTING
&TISSUE FORCEPS



AS-08-101 THOLE
for internal and external
measurements, graduated in
centimeters

1/3



1/2

AS-08-102
DE LEE
graduated in centimeters
and inches

for internal
measurements between
symphysis and
promontory



1/3

AS-08-103
COLLIN
graduated in
centimeters

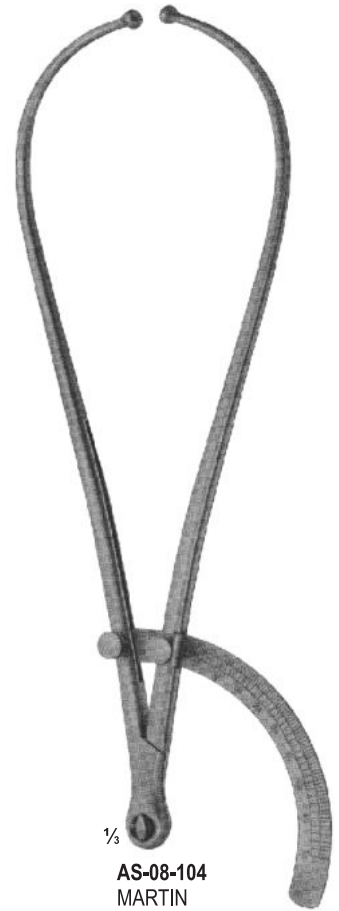

1/3

AS-08-104
MARTIN
graduated in
centimeters



1/3

AS-08-105
COLLIN
graduated in
centimeters
The additional straight arm
can be replaced. The pelvimeter
with straight arm is used for
localisation of the portio vaginalis
uteri and of vaginal metastasis.



1/3

AS-08-106
BREISKY
graduated in
centimeters

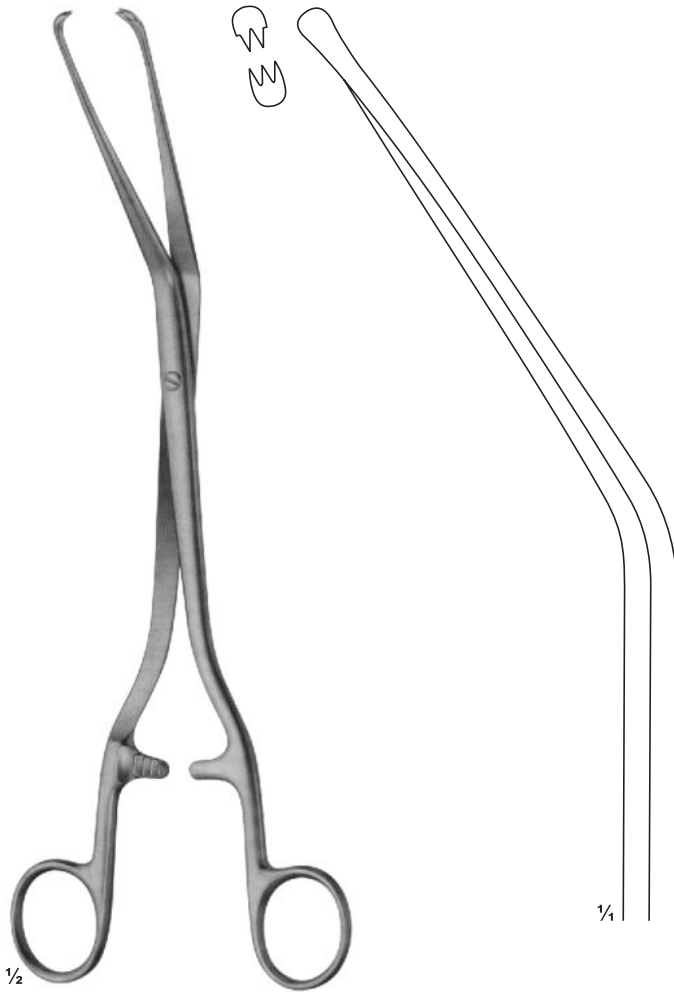

AS-08-107
HERFF
puncturing
forceps 225 mm



AS-08-108
IOWA
puncturing
forceps 260 mm



1/3

AS-08-109
SIMPSON-BRAUN
305mm

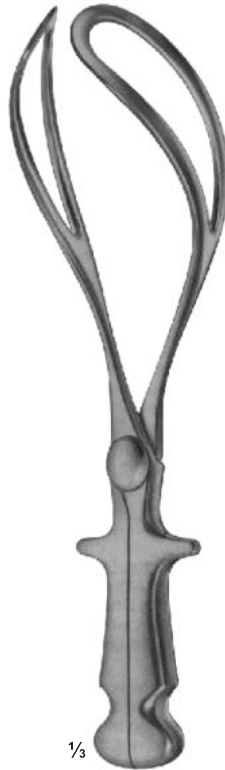

1/3

AS-08-110
SIMPSON
355 mm



1/3

AS-08-111
SIMPSON-BRAUN
400 mm



1/3

AS-08-112
SIMPSON-BRAUN
305mm



1/3

AS-08-113
SIMPSON
235mm



1/3

AS-08-114
WRIGLEY
250 mm



BRAUN
Cranioclast
AS-08-115
420 mm

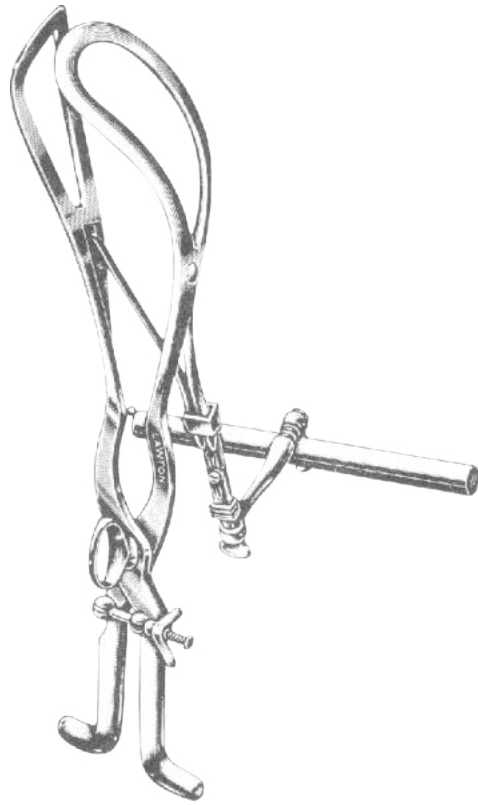

TARNIER
AS-08-116
400 mm

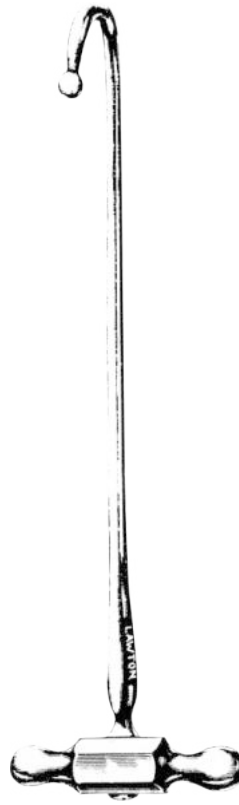

BRAUN
AS-08-117
310 mm



SMELLIE
AS-08-118
305 mm

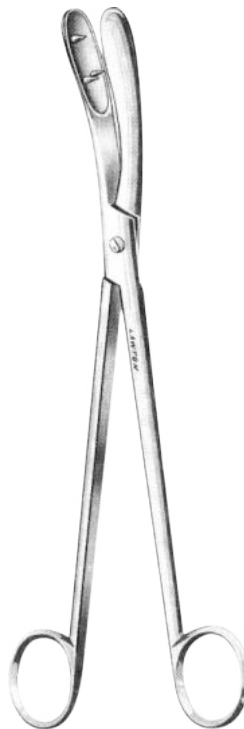

BOER
AS-08-119
290 mm



SMELLIE
Perforator
AS-08-120
270 mm



GREEN-ARMYTAGE AS-08-121
Caesarean section haemostatic
forceps, for edges of the
transverse incision in the lower
segment
220 mm

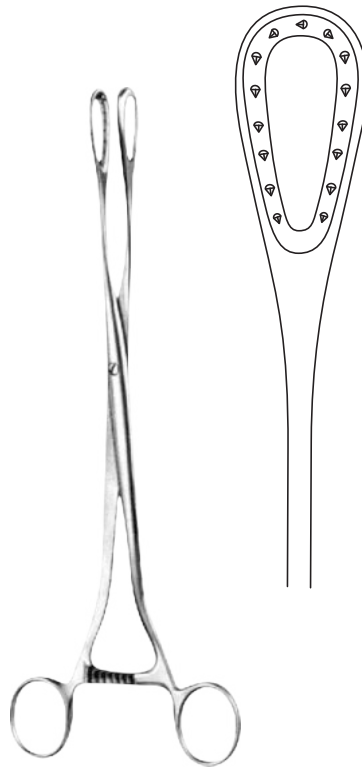

SANGER AS-08-122
275 mm

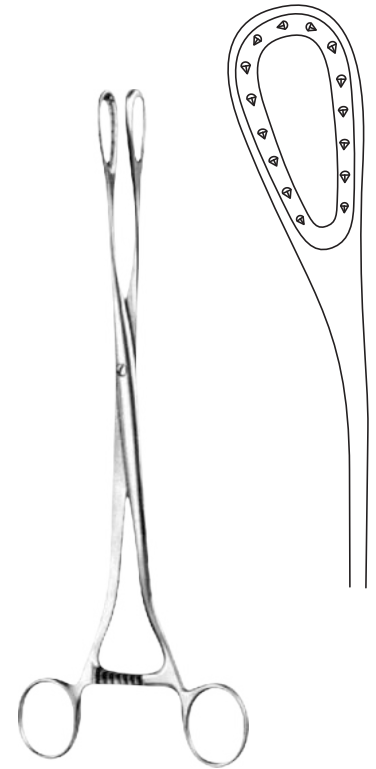

SANGER AS-08-123 - AS-08-124
AS-08-123 270 mm
AS-08-124 290 mm



GAUSS AS-08-125
Scalpel Flap
forceps
260 mm



WILLETT AS-08-126
Scalpel Flap
forceps
185 mm



SELLHEIM AS-08-17
320 mm

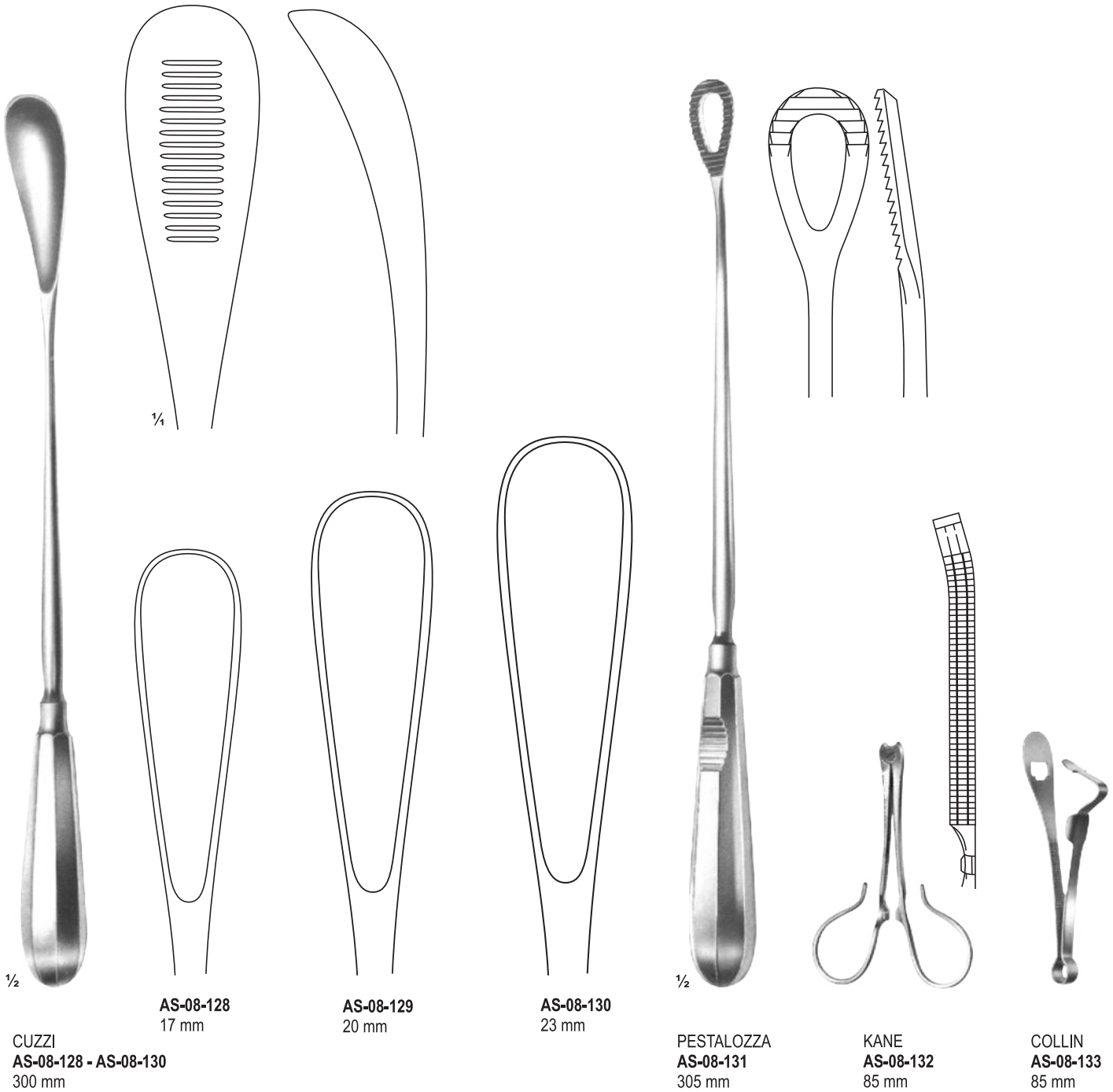

$\frac{1}{2}$
CUZZI
AS-08-128 - AS-08-130
300 mm

AS-08-128
17 mm

AS-08-129
20 mm

AS-08-130
23 mm

$\frac{1}{2}$
PESTALOZZA
AS-08-131
305 mm

KANE
AS-08-132
85 mm

COLLIN
AS-08-133
85 mm



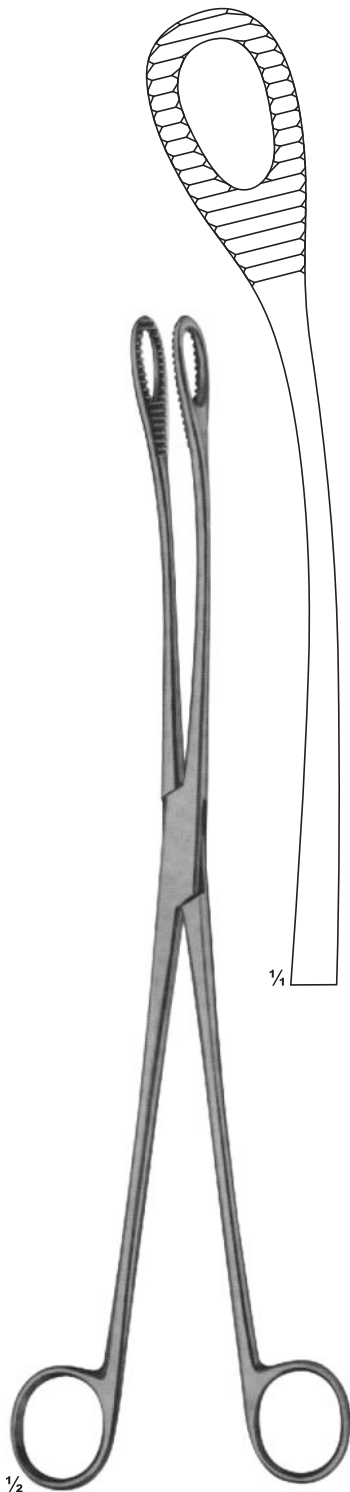

AS-08-141
KELLY
320mm



AS-08-142
SMELLIE
Perforator
270mm



AS-08-143
BRAUN
Cranioclast
t 420mm



AS-08-144
BOSE
165 mm



AS-08-145
BOSE
165 mm



AS-08-146 - AS-08-148
180 mm



AS-08-146
sharp



AS-08-147
blunt



AS-08-148
stumpf/blunt

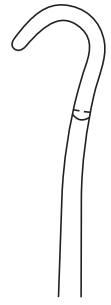

AS-08-149
FINSEN 50
mm

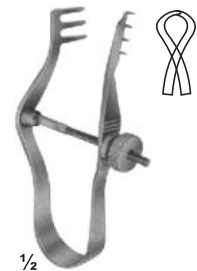

AS-08-150
FINSEN 70
mm



AS-08-151
TROUSSEAU
120 mm



AS-08-152
LABORDE
125 mm



AS-08-153
LABORDE
strong pattern
135 mm



AS-08-154
Cleaning Brush
for tracheal
tubes 285 mm



ASAMAR
SURGICAL 

PAGE
157-185
HAEMOSTATIC FORCEPS

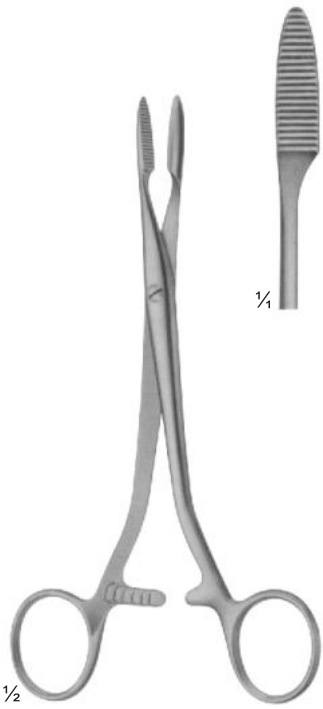

PEAN
AS-09-101 160 mm
AS-09-102 180 mm

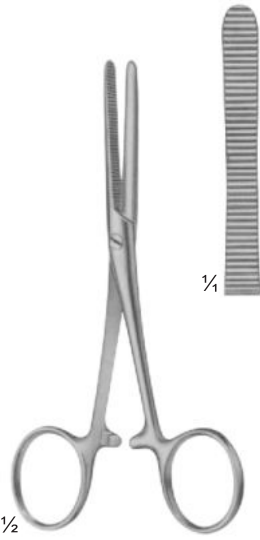

PEAN
AS-09-103
125 mm

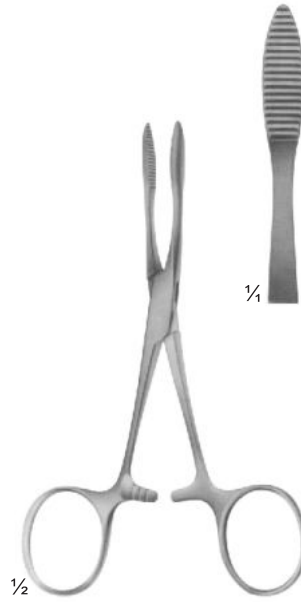

PEAN
AS-09-104 125 mm
AS-09-105 140 mm

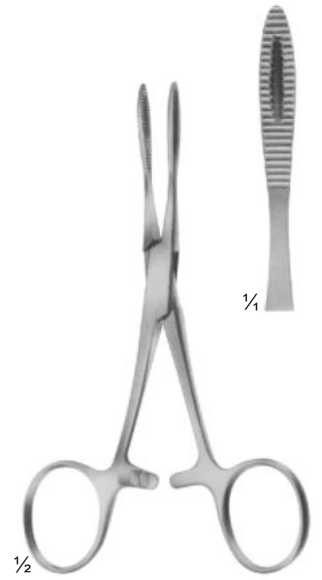

KRONLEIN
AS-09-106
130 mm



SPENCER-WELLS
AS-09-107 - AS-09-113
AS-09-107 130 mm
AS-09-108 140 mm
AS-09-109 150 mm
AS-09-110 180 mm
AS-09-111 200 mm
AS-09-112 250 mm
AS-09-113 300 mm

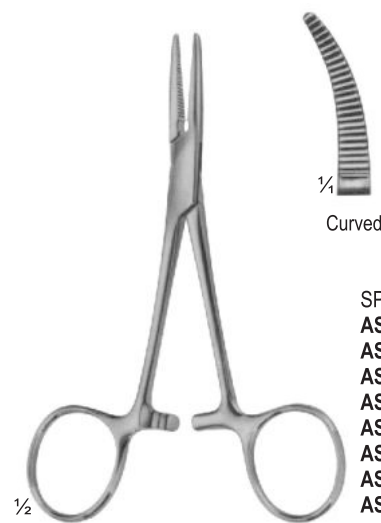

SPENCER-WELLS
AS-09-114 - AS-09-120
AS-09-114 130 mm
AS-09-115 140 mm
AS-09-116 150 mm
AS-09-117 180 mm
AS-09-118 200 mm
AS-09-119 250 mm
AS-09-120 300 mm

DELICATE HAEMOSTATIC FORCEPS

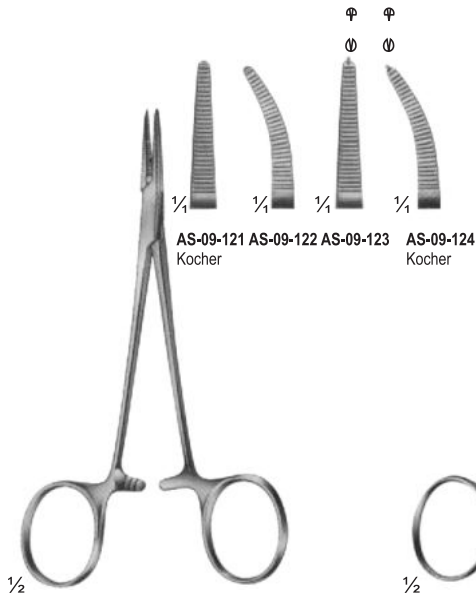

AS-09-121 - AS-09-124
HALSTED-MOSQUITO
125 mm

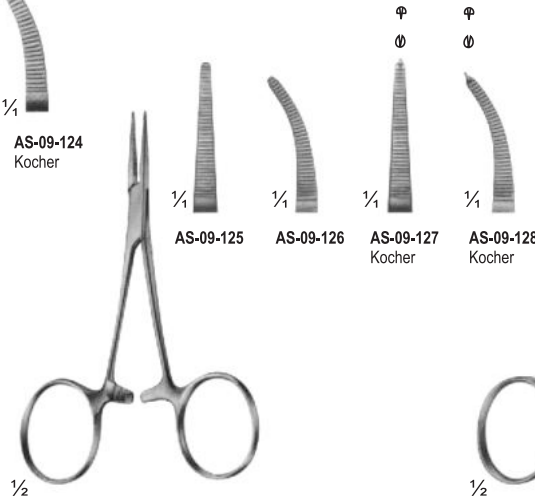

AS-09-125 - AS-09-128
BABY-MOSQUITO
(HARTMANN)
100 mm

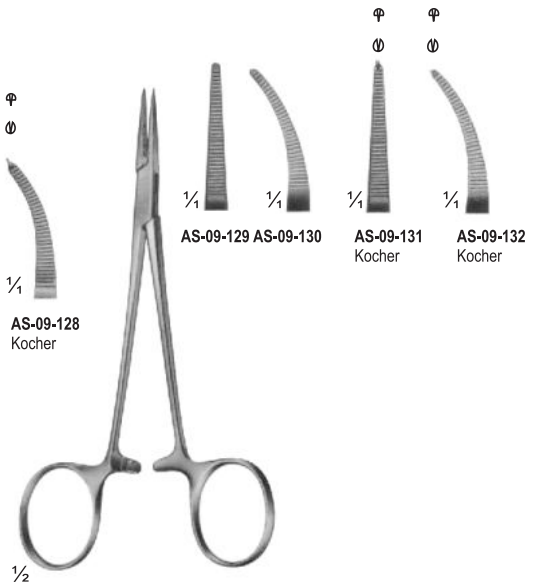

AS-09-129 - AS-09-132
MICRO-HALSTED
125 mm

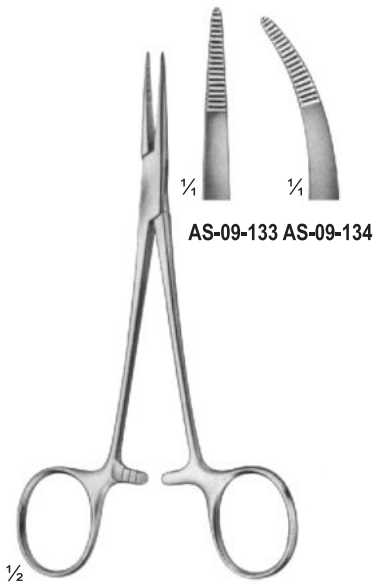

AS-09-133 - AS-09-134
PROVIDENCE-HOSPITAL
140 mm



AS-09-135 - AS-09-136
KELLY
140 mm

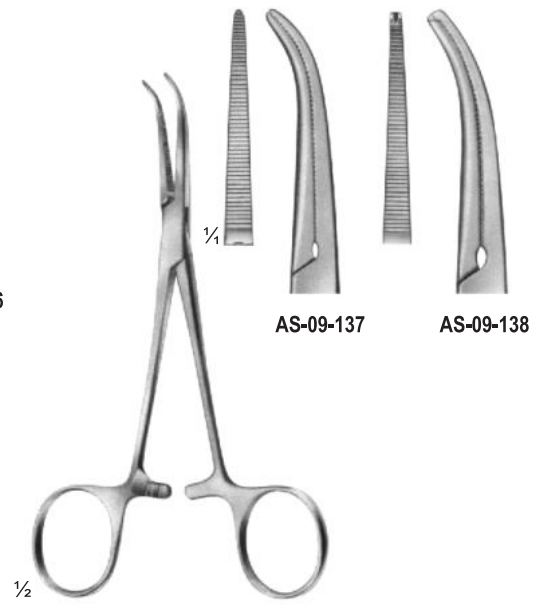

AS-09-137 - AS-09-138
DANDY
Curved sideways
140 mm

DELICATE HAEMOSTATIC FORCEPS



ASAMAR
SURGICAL

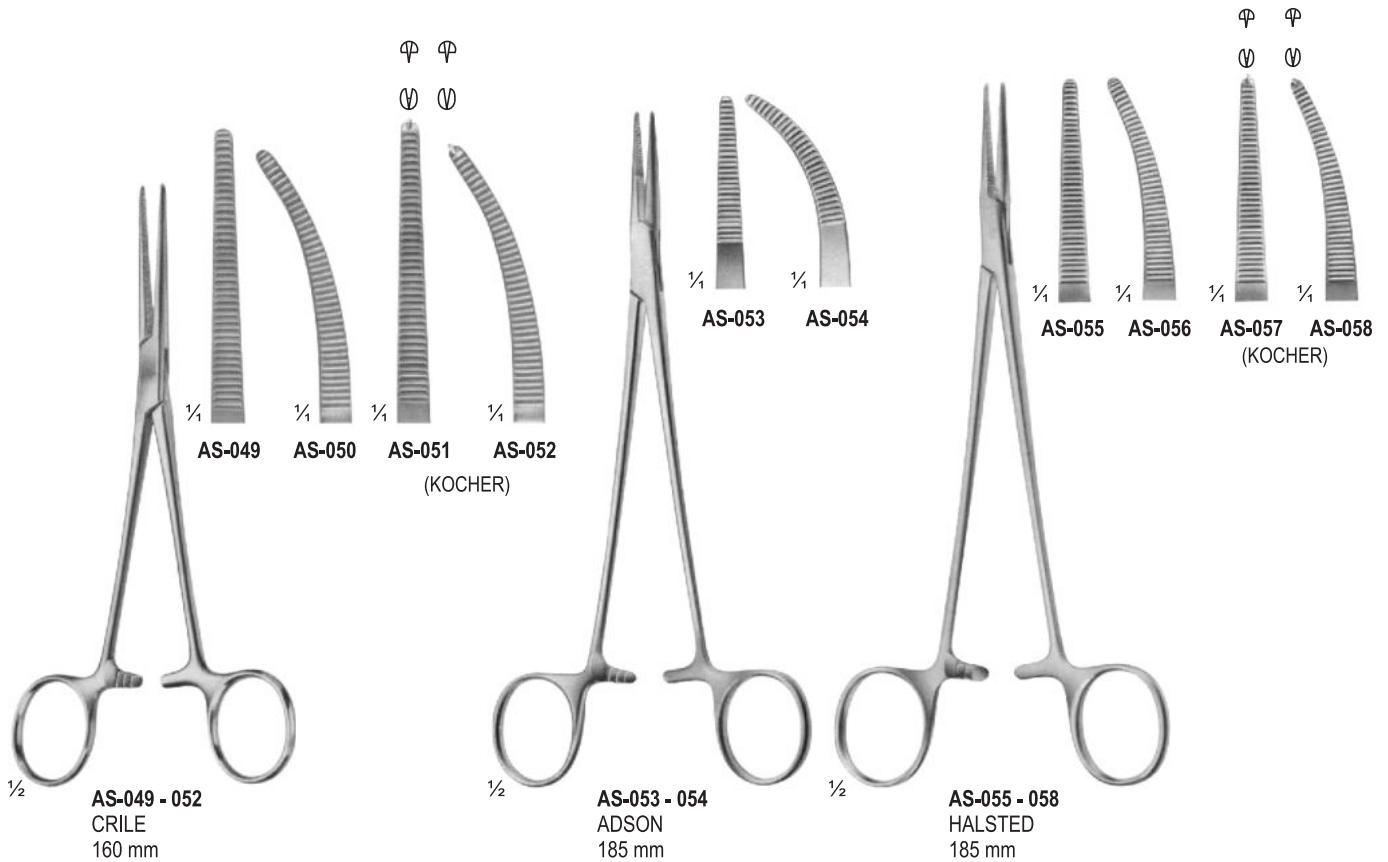
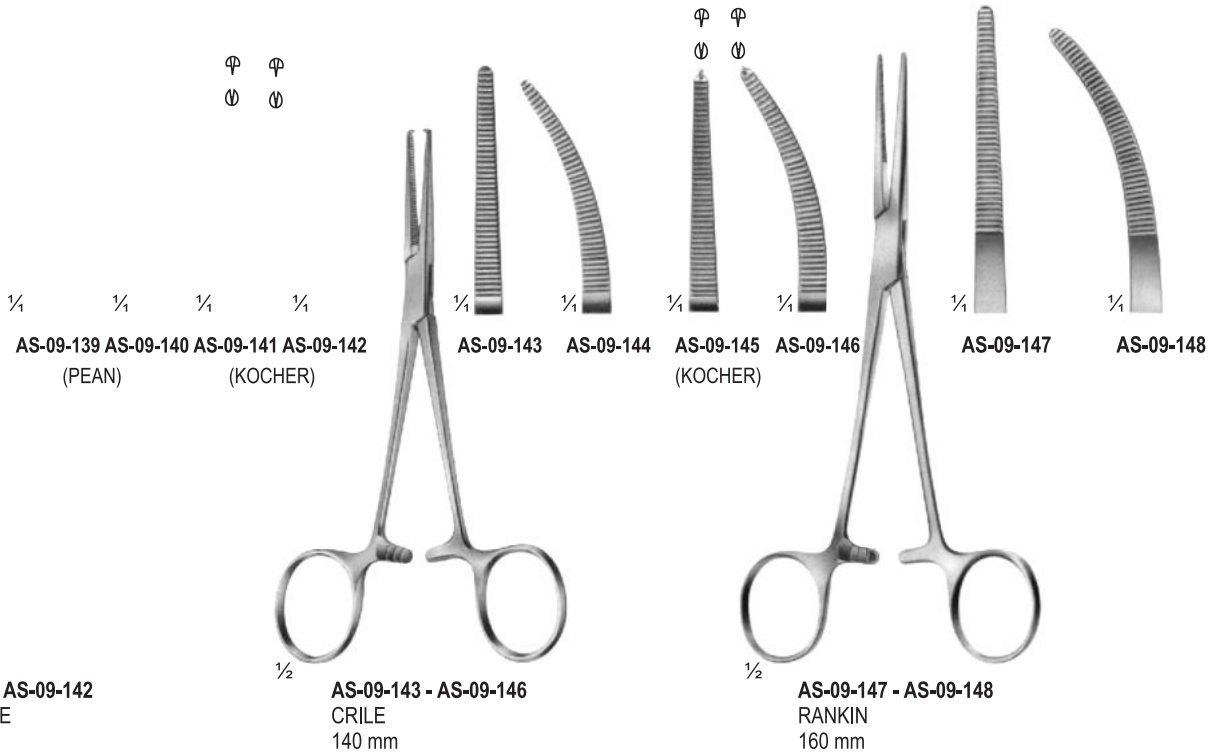

DELICATE HAEMOSTATIC FORCEPS



1/2
AS-09-159 - AS-09-163
 HEISS
 200 mm



1/4
AS-09-159



1/4
AS-09-160



1/4
AS-09-161



1/4
AS-09-162



1/4
AS-09-163

(Kocher)

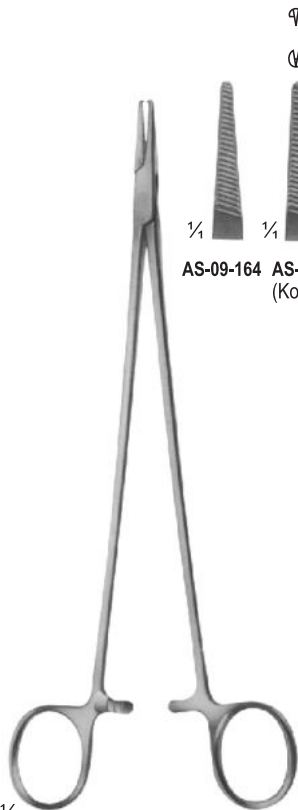

1/2
AS-09-164 - AS-09-165
 HALSTED
 215 mm

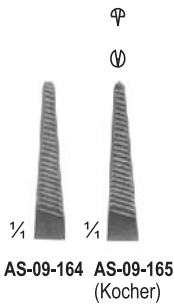

1/4 1/4
AS-09-164 AS-09-165
 (Kocher)

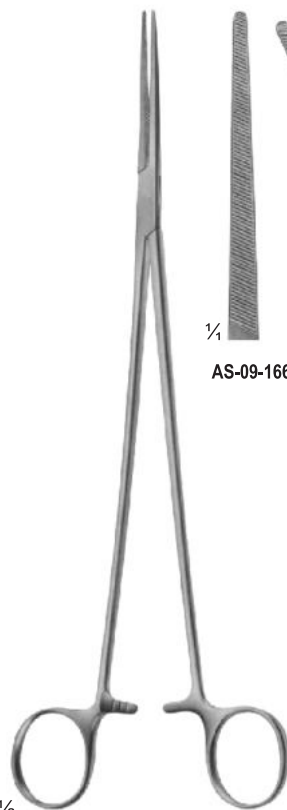

1/2
AS-09-166 - AS-09-169
 BENGOLEA
 245 mm

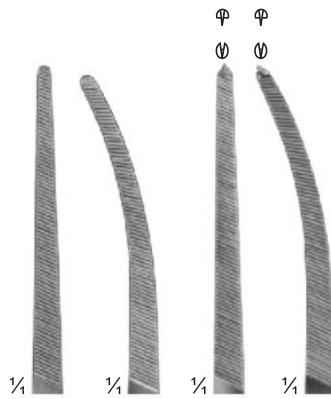

1/4 1/4 1/4 1/4
AS-09-166 AS-09-167 AS-09-168 AS-09-169
 (Kocher)

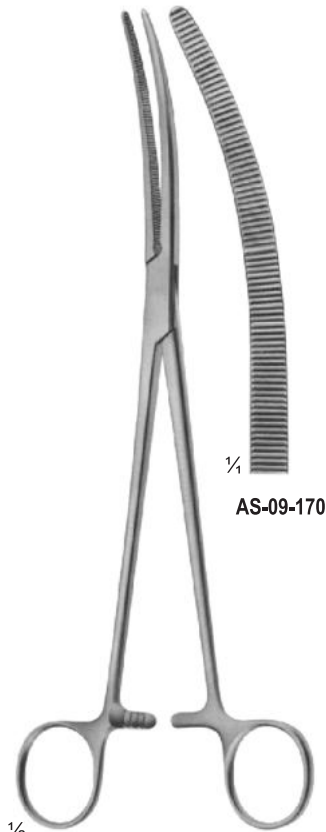

1/2
AS-09-170
 CRAFOORD
 245 mm

1/4
AS-09-170

DELICATE HAEMOSTATIC FORCEPS

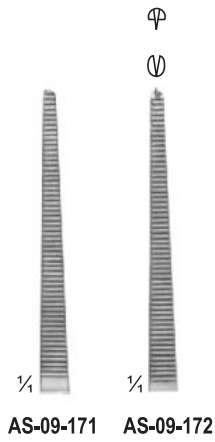
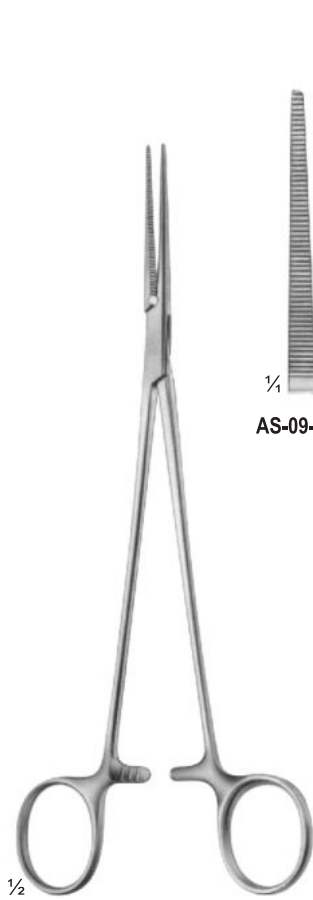

AS-09-171 AS-09-172

1/2
HALSTED-MOSQUITO
AS-09-171 180 mm
AS-09-172 210 mm

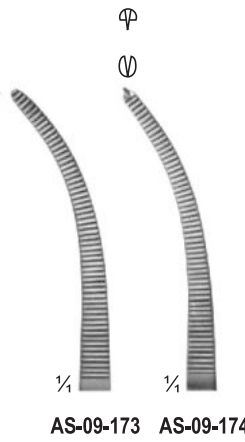
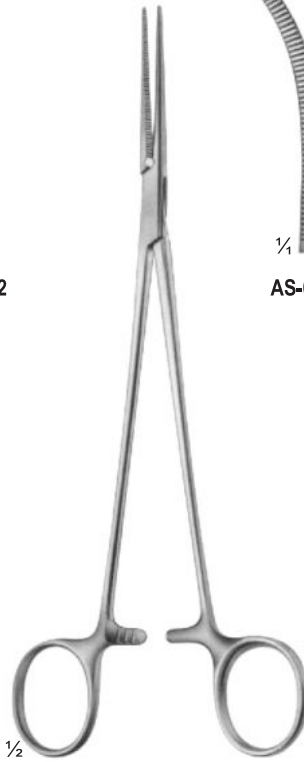

AS-09-173 AS-09-174

1/2
HALSTED-MOSQUITO
AS-09-173 180 mm
AS-09-174 210 mm

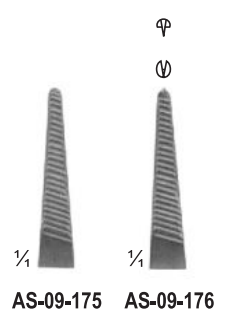
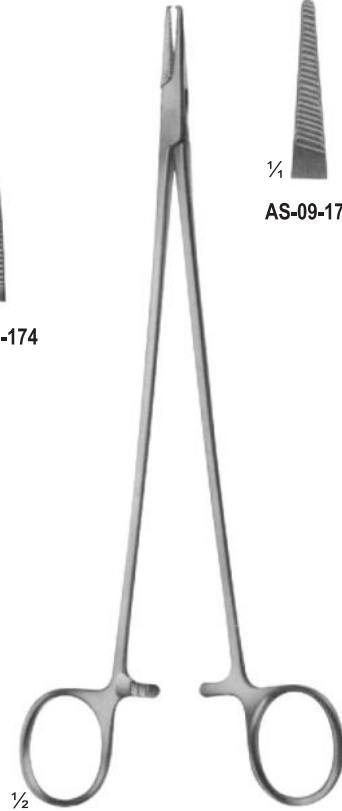

AS-09-175 AS-09-176

1/2
HALSTED
AS-09-175 - AS-09-176
215 mm



MARTIN-FUCHSIG
AS-09-177
200 mm

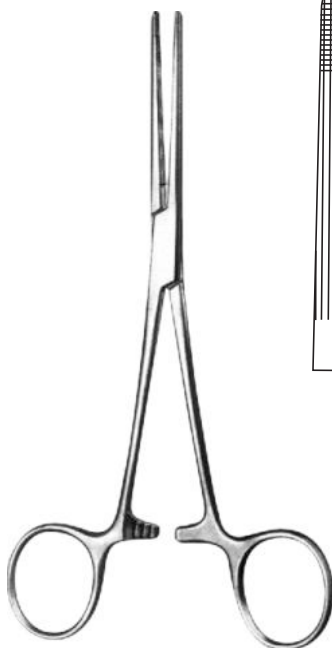

ROCHESTER-CARMALT
AS-09-178 170 mm AS-
09-179 200 mm

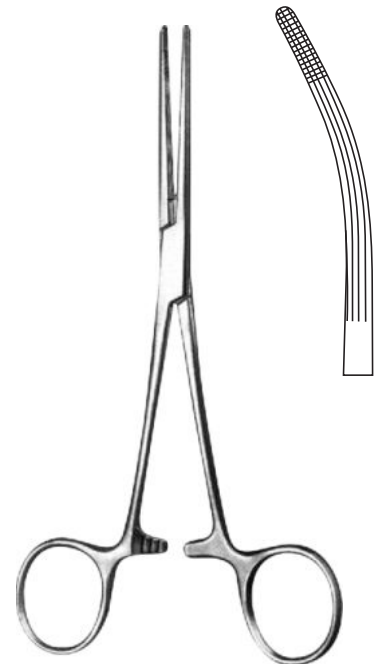

ROCHESTER-CARMALT
AS-09-180 160 mm AS-
09-181 200 mm

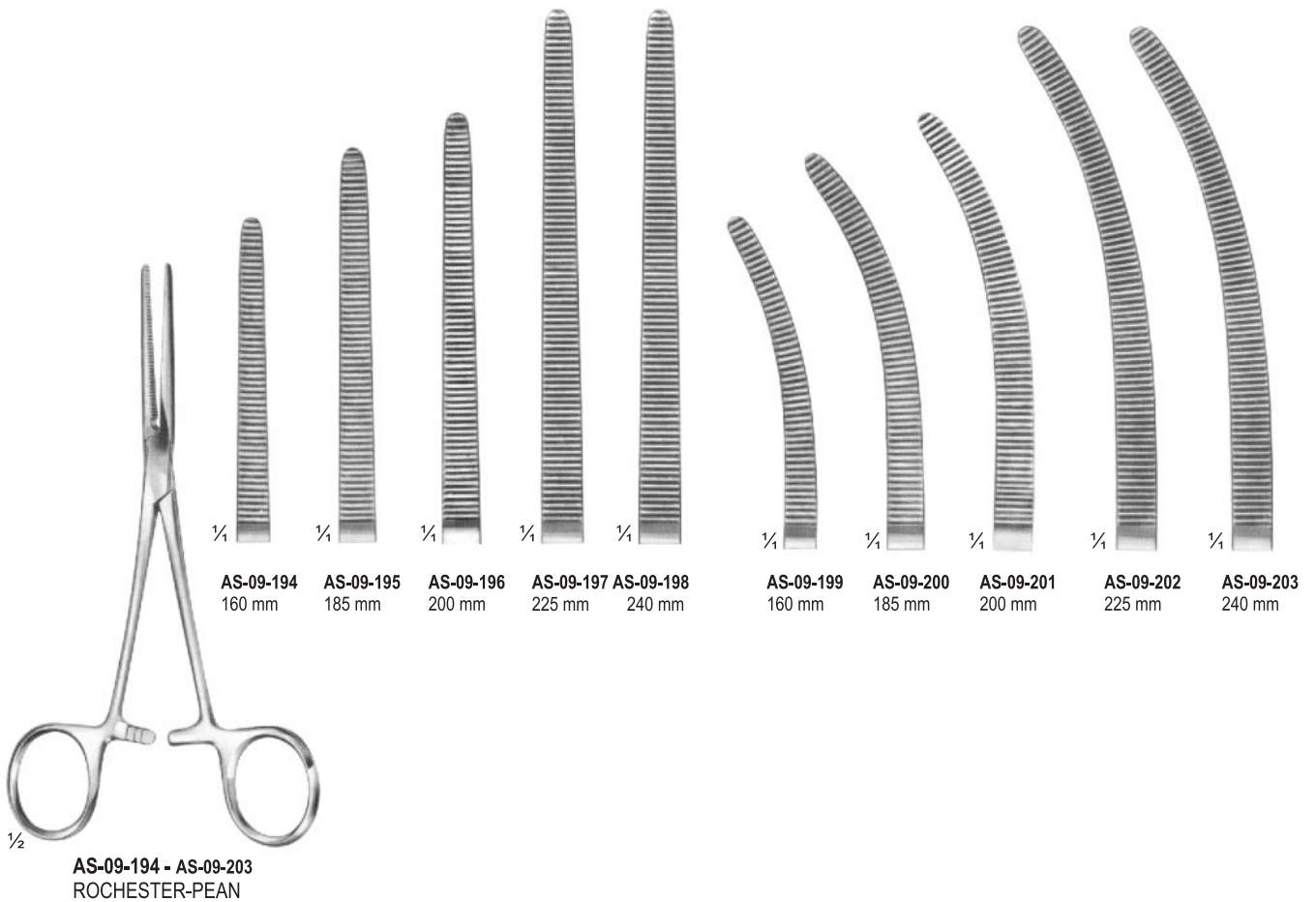
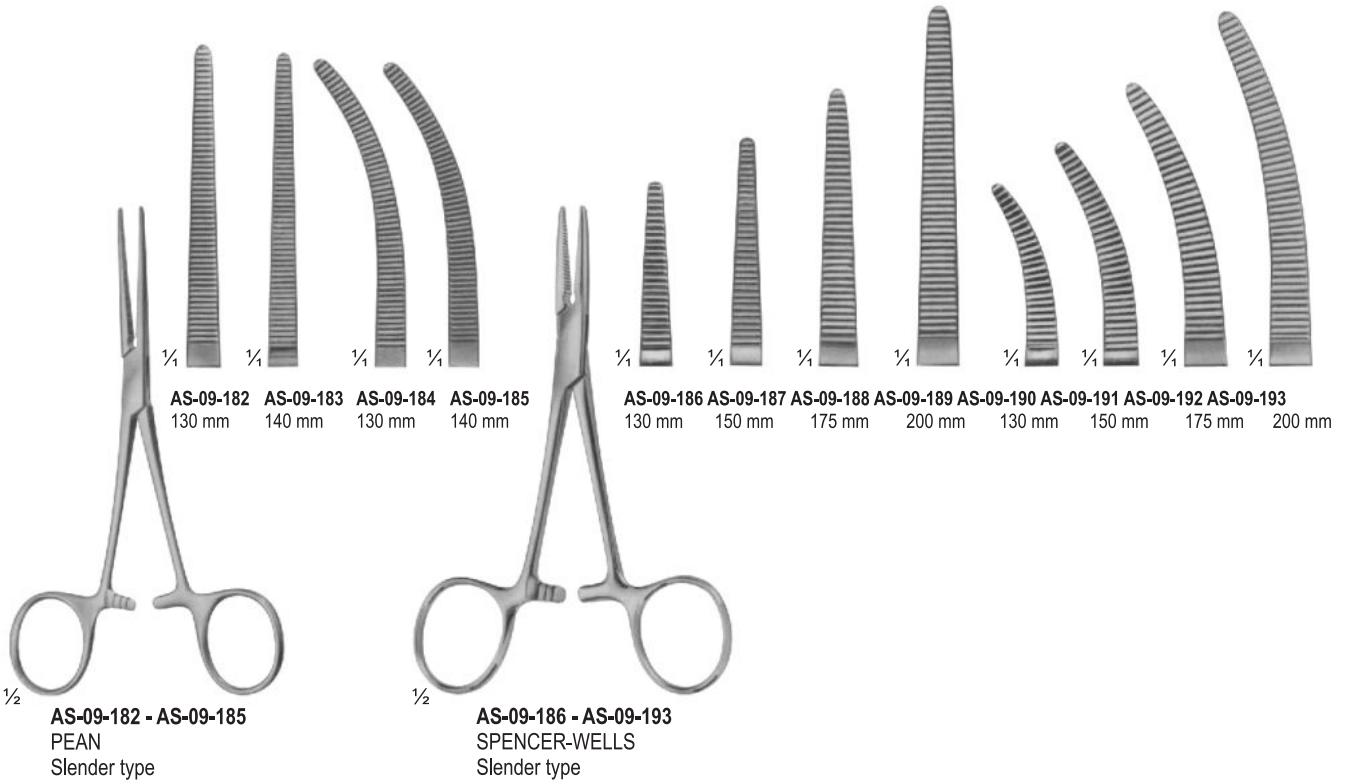

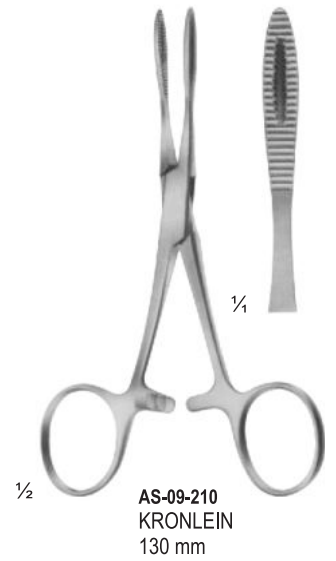
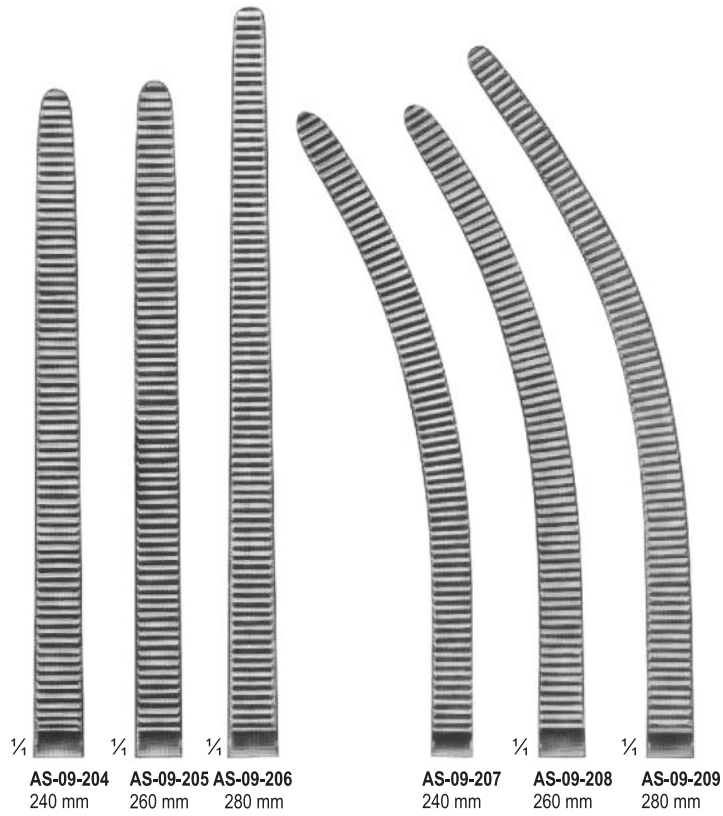

$\frac{1}{2}$ AS-09-204 - AS-09-209
 PEAN

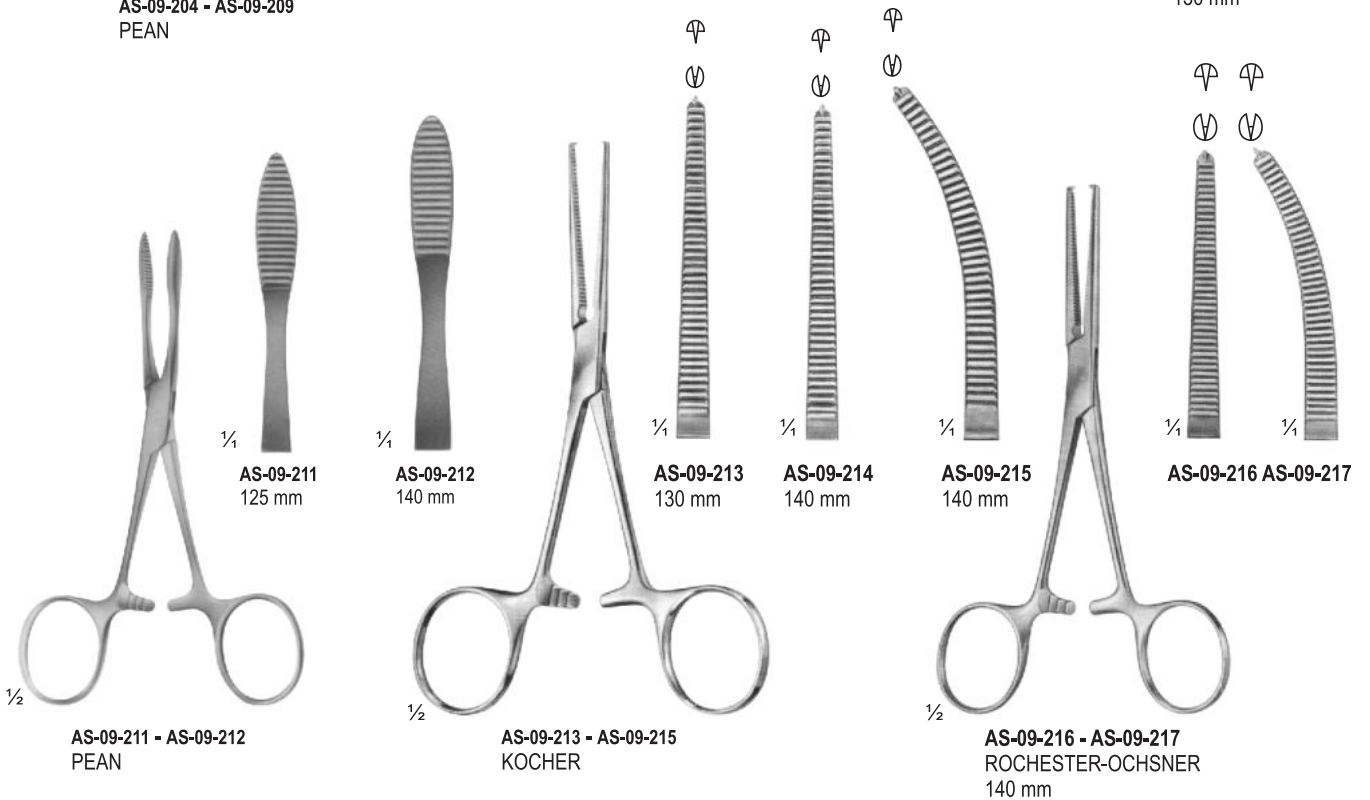



$\frac{1}{2}$ **AS-09-218 - AS-09-223**
KOCHER-OCHSNER (STR)

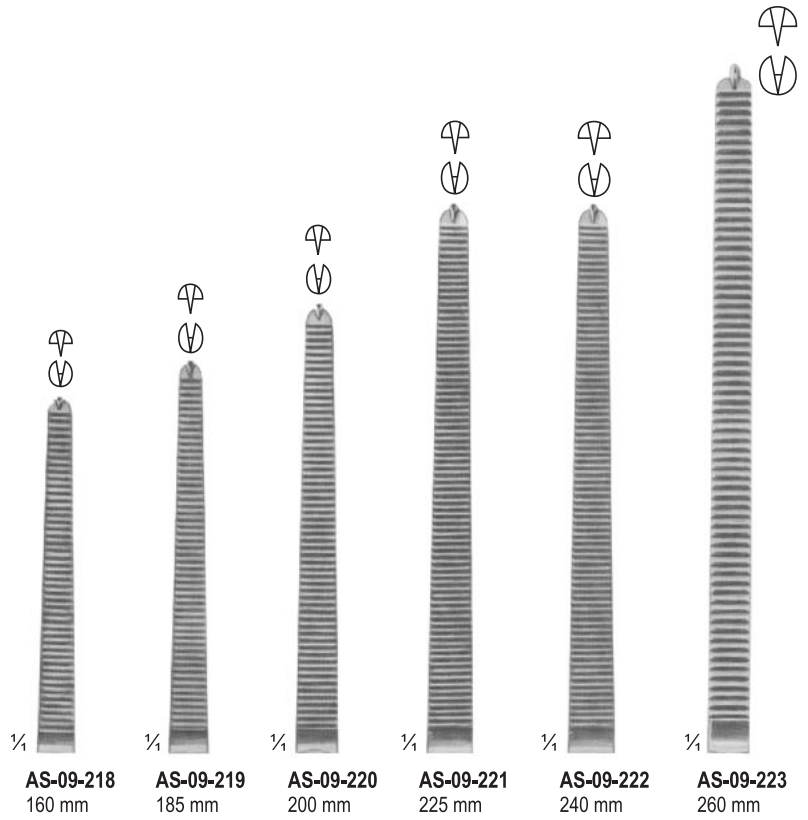

$\frac{1}{2}$ **AS-09-224 - AS-09-229**
KOCHER-OCHSNER (CVD)

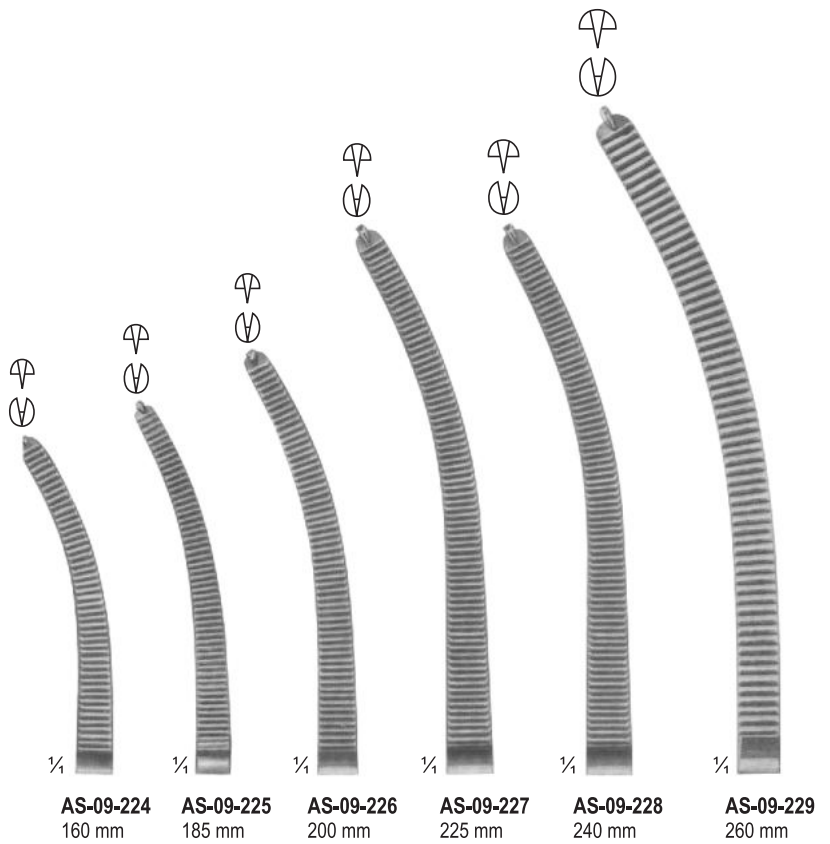

$\frac{1}{4}$ $\frac{1}{4}$ $\frac{1}{4}$ $\frac{1}{4}$
AS-09-230 AS-09-231 AS-09-232 AS-09-233
 160 mm 200 mm 160 mm 200 mm

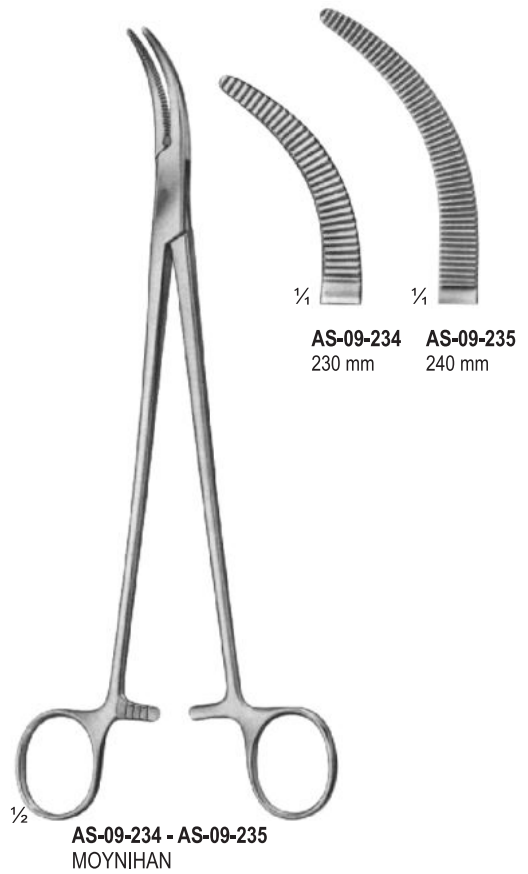

$\frac{1}{2}$ **AS-09-230 - AS-09-233**
 ROCHESTER-CARMALT

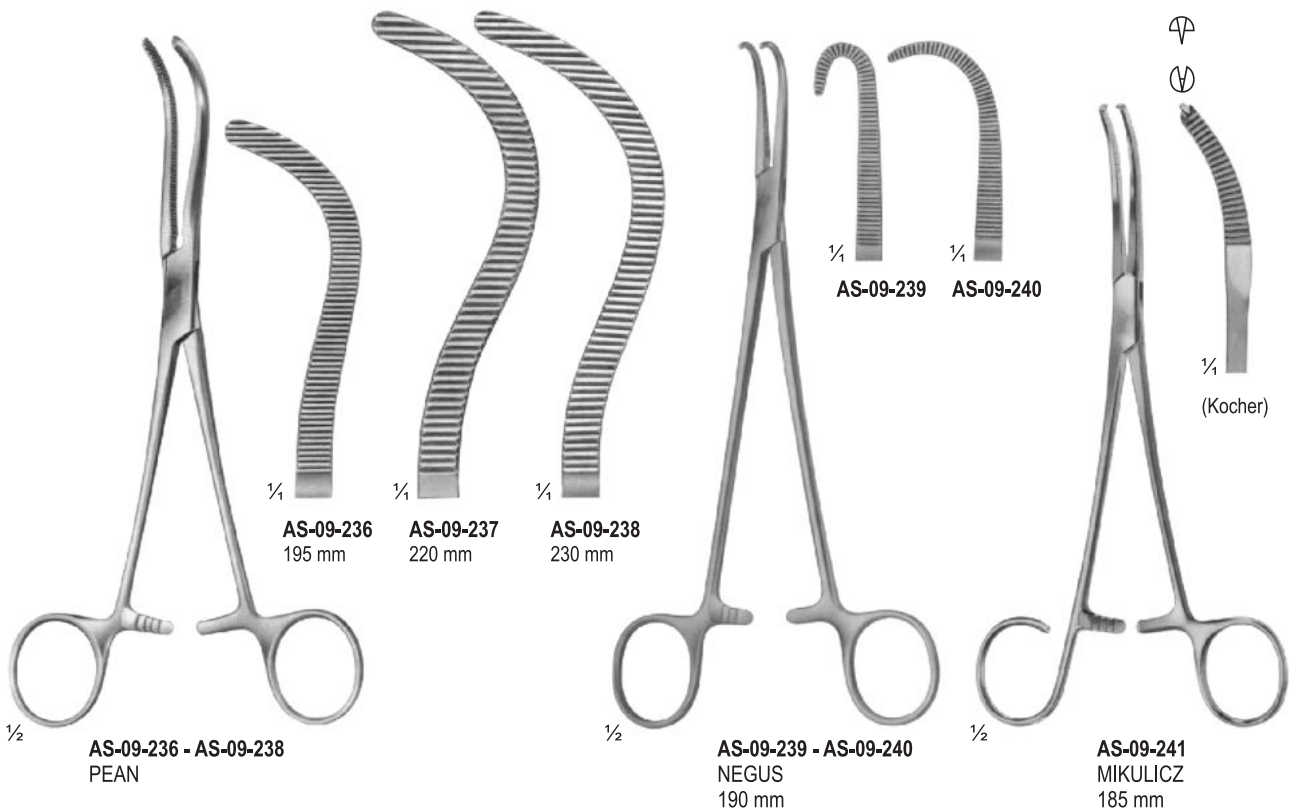

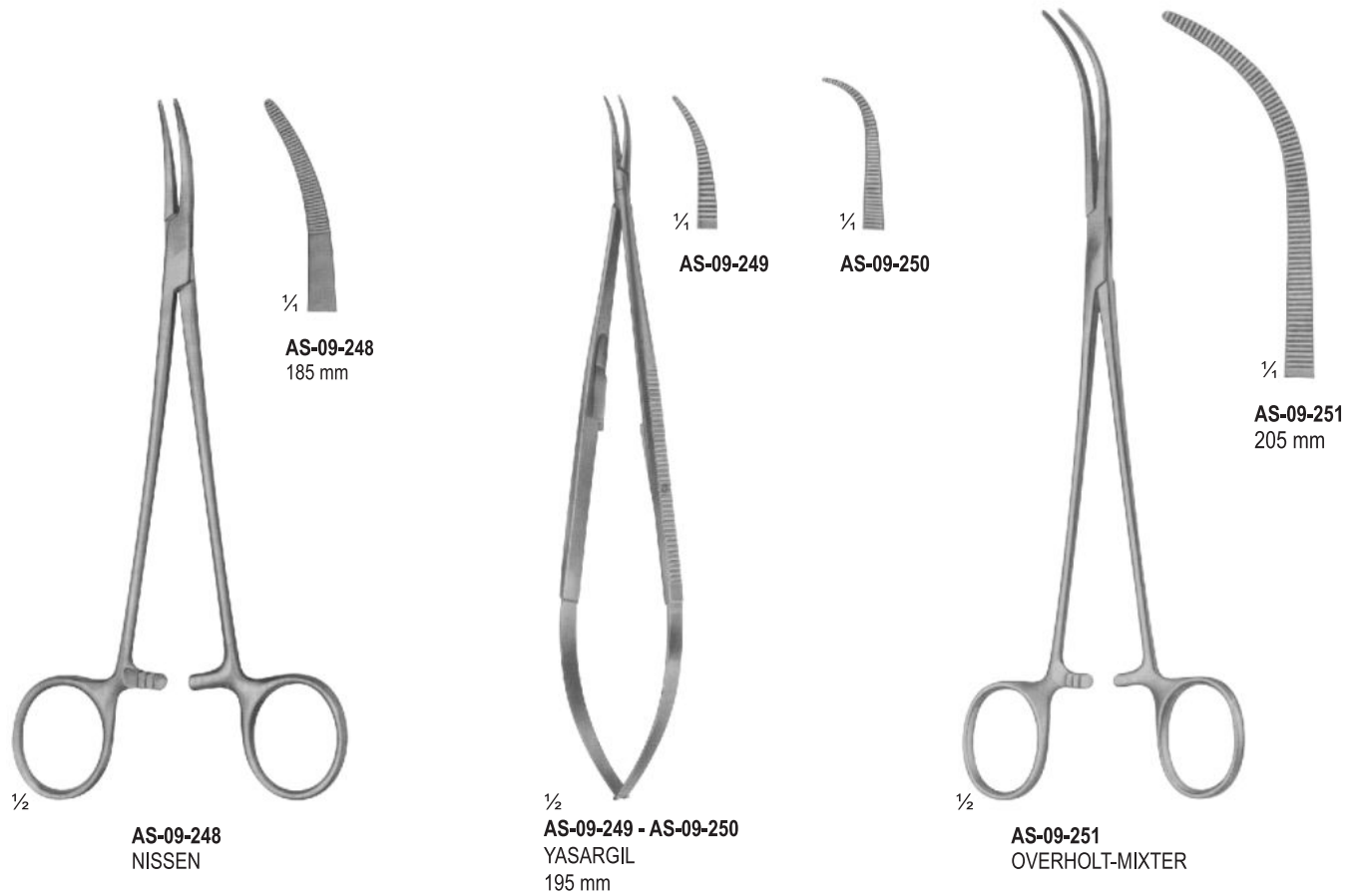



CRAFOORD
AS-09-252 - AS-09-253

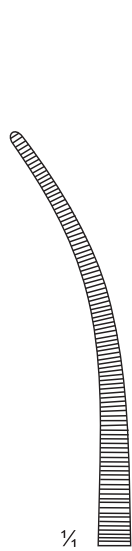

AS-09-252
180 mm

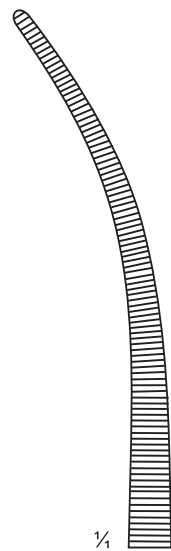

AS-09-253
240 mm

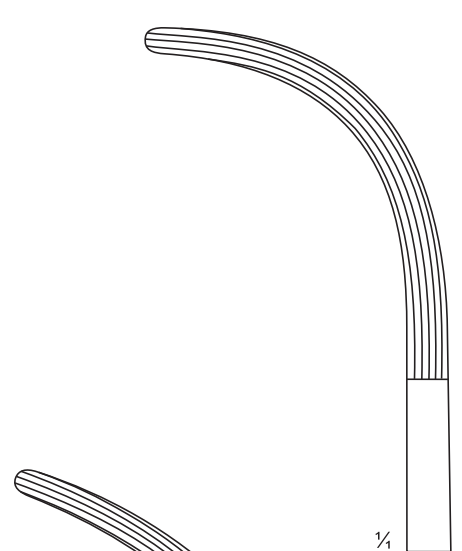

AS-09-256



CRAFOORD-SELLORS
AS-09-254 - AS-09-256
240 mm

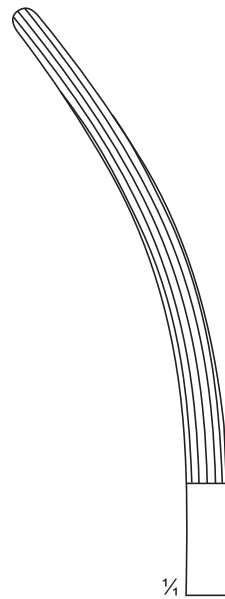

AS-09-254



AS-09-255

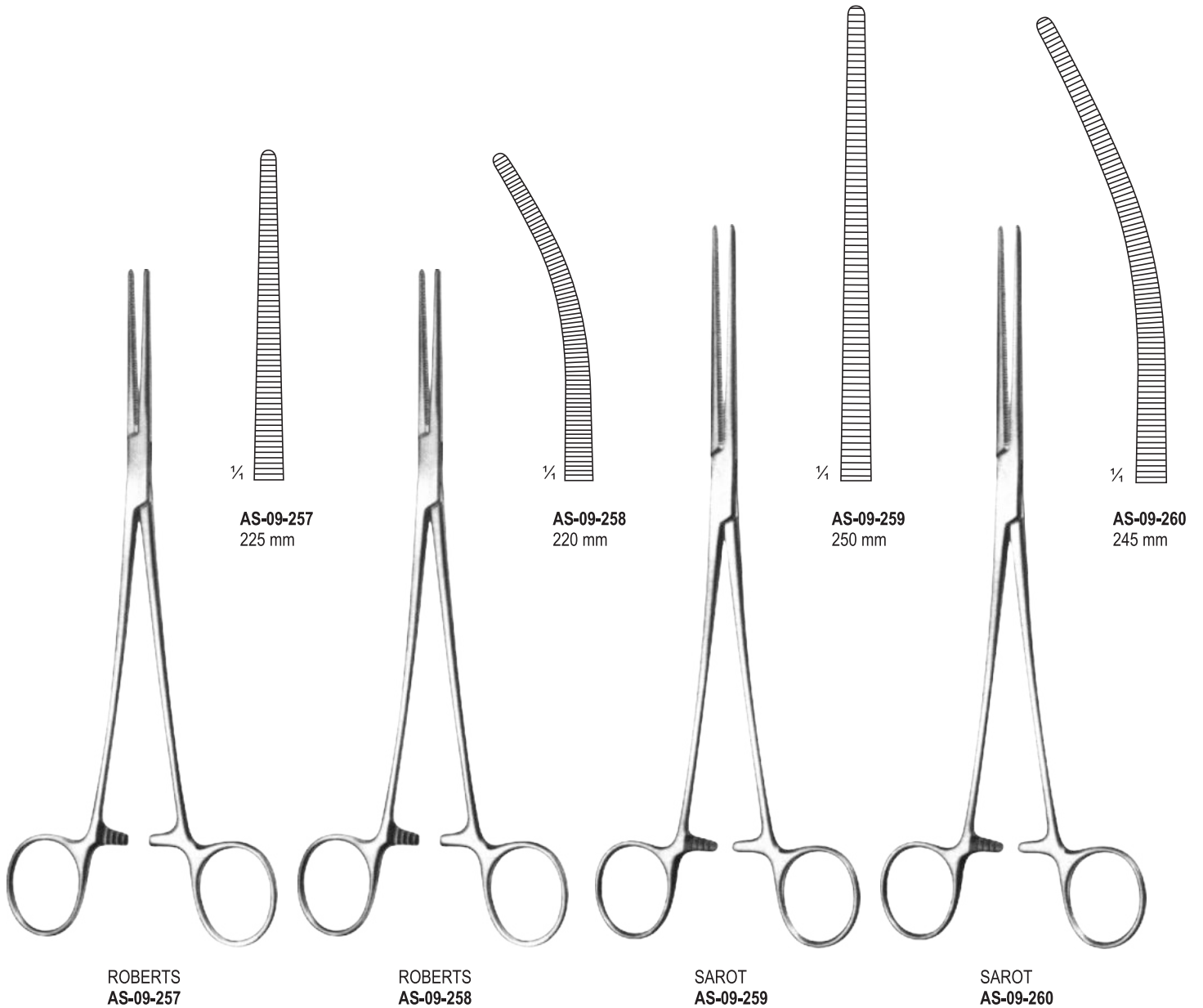

DISSECTING- AND LIGATURE FORCEPS

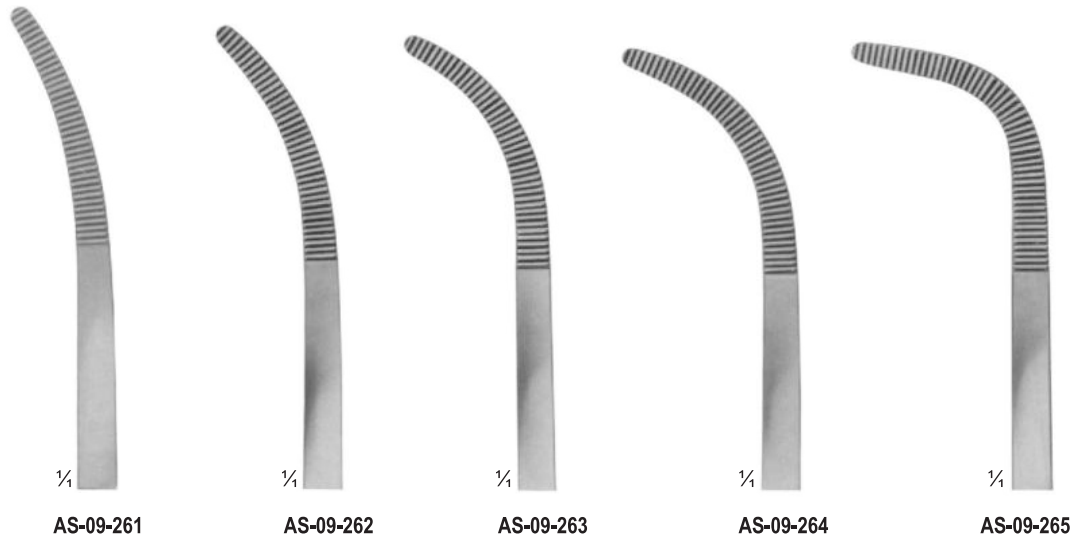

RUMEL
AS-09-261 - AS-09-265
240 mm

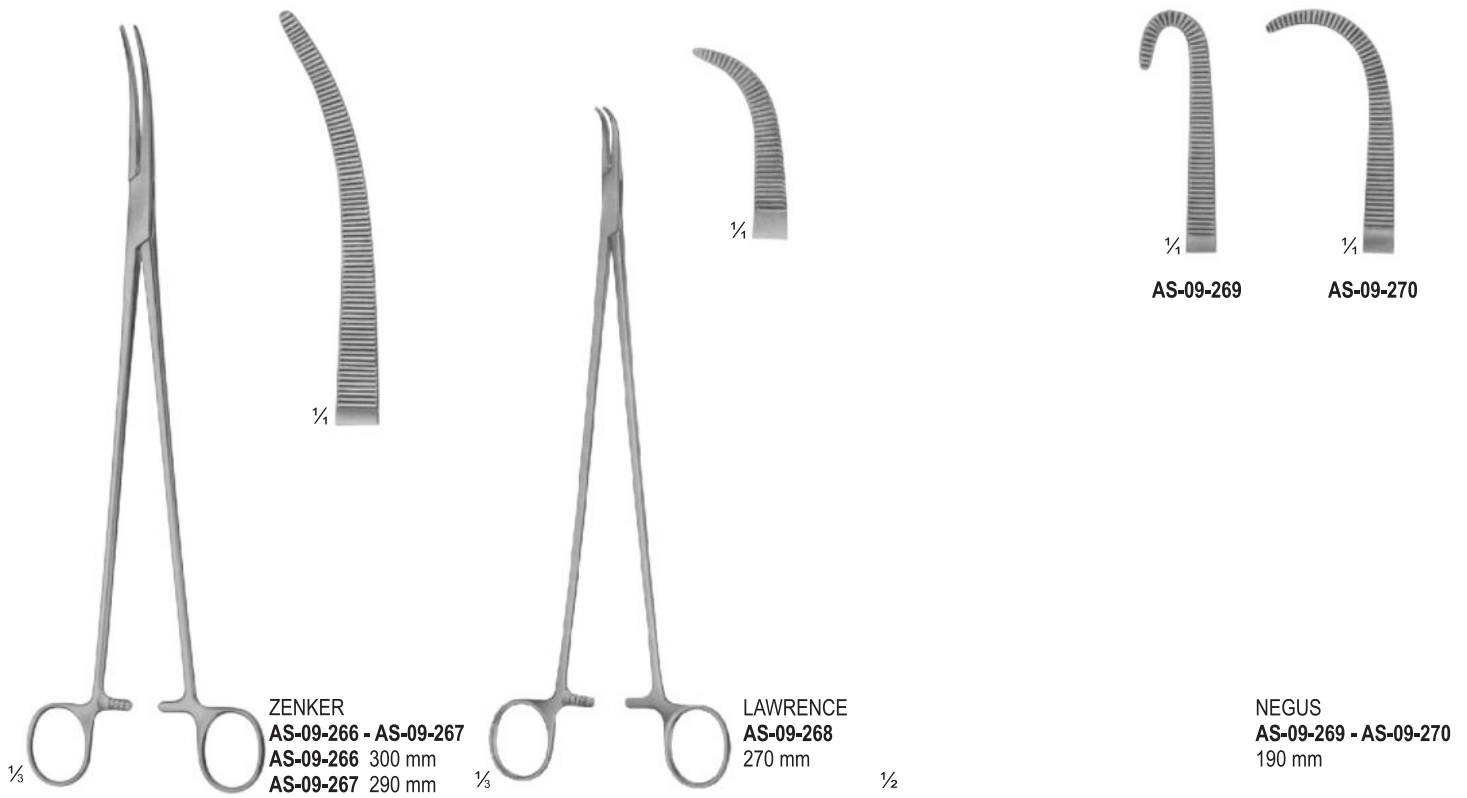

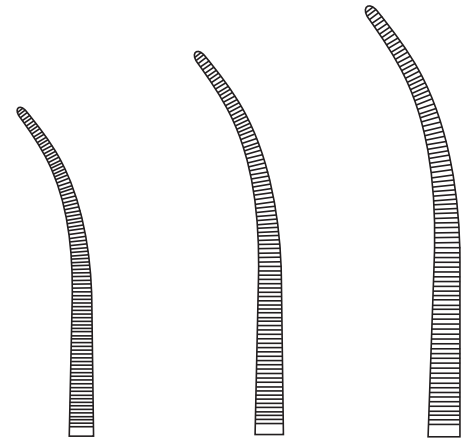
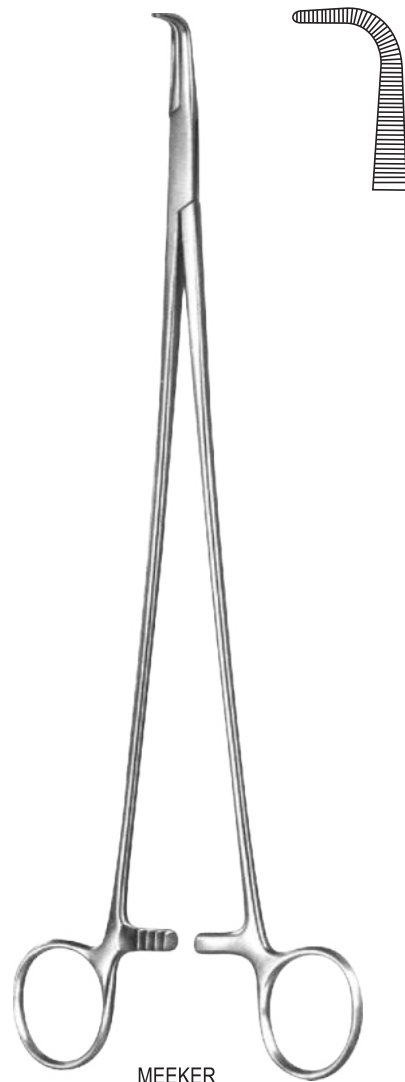

Fig. 1 **AS-09-272**
190 mm

Fig. 1 **AS-09-273**
225 mm

Fig. 1 **AS-09-274**
240 mm



MEEKER
AS-09-271
280 mm



KELLY
AS-09-272 - AS-09-280

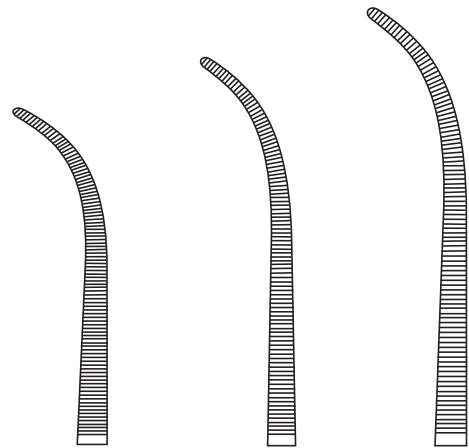

Fig. 2 **AS-09-275**
190 mm

Fig. 2 **AS-09-276**
220 mm

Fig. 2 **AS-09-277**
235 mm

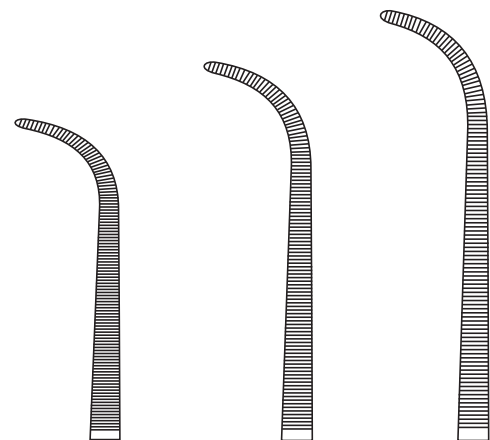
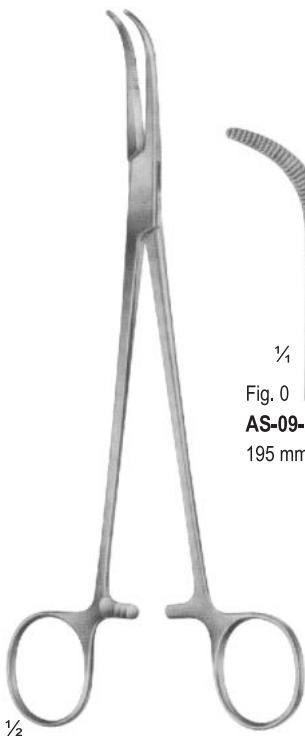

Fig. 3 **AS-09-278**
185 mm

Fig. 3 **AS-09-279**
215 mm

Fig. 3 **AS-09-280**
235 mm



1/2
AS-09-281 - AS-09-292
 OVERHOLT-GEISSENDOERFER

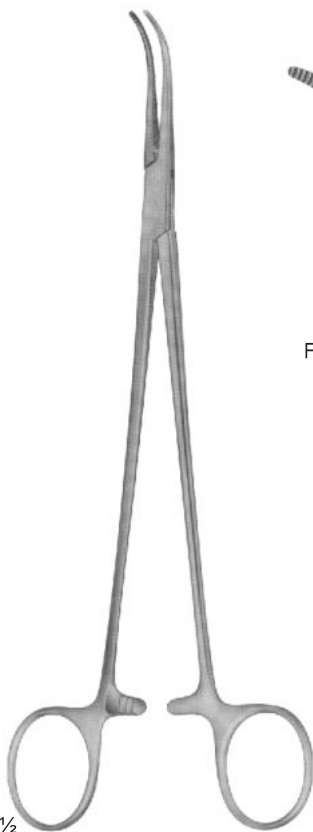
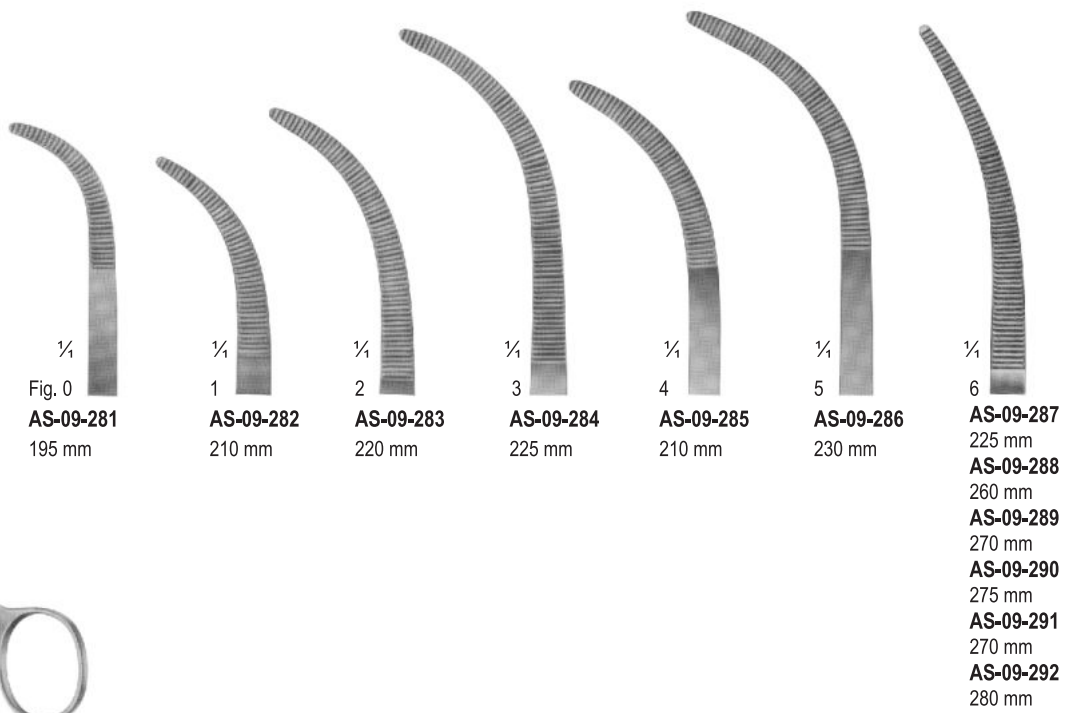

1/2
AS-09-293 - AS-09-300
 OVERHOLT
 fine pattern





MINI-GEMINI
AS-09-301 - AS-09-304

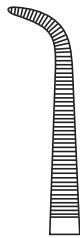

AS-09-301
180 mm

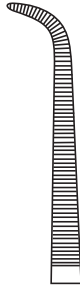

AS-09-302
230 mm

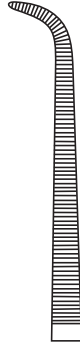

AS-09-303
250 mm



AS-09-304
280 mm

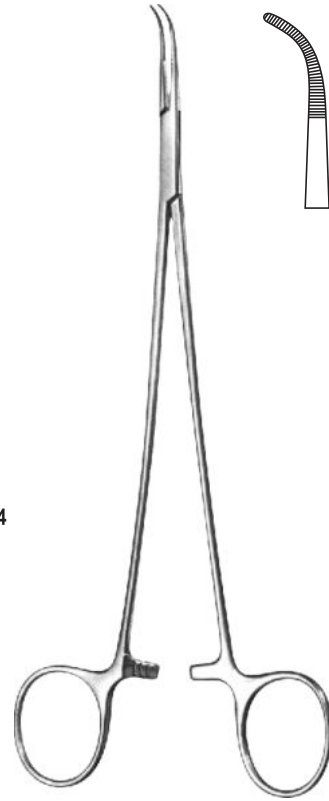

OVERHOLT-MINI
AS-09-305
200 mm



GEMINI
AS-09-306 - AS-09-312

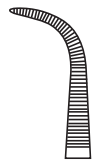

AS-09-306
130 mm

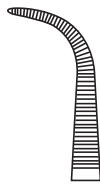

AS-09-307
160 mm

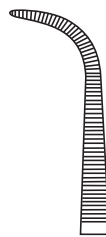

AS-09-308
180 mm

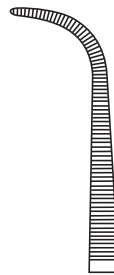

AS-09-309
210 mm

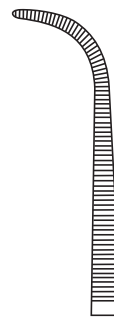

AS-09-310
230 mm

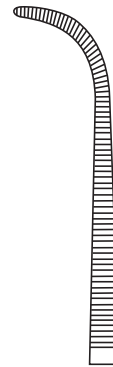

AS-09-311
250 mm

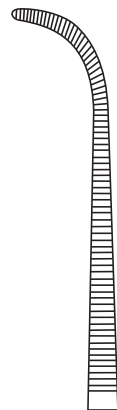

AS-09-312
280 mm

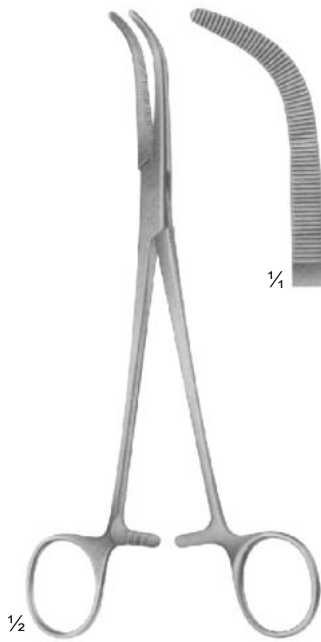

AS-09-313 MIXTER-O'SHAUGNESSY
190 mm

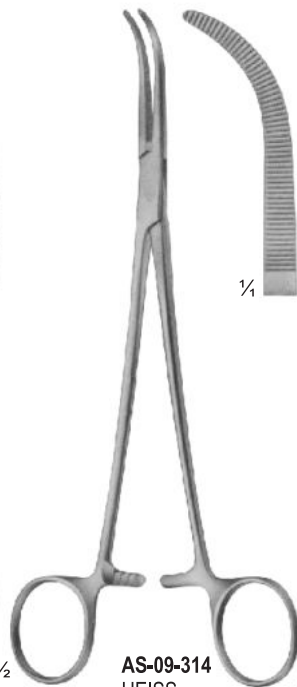

AS-09-314 HEISS
195 mm



AS-09-315 - AS-09-319 RUMEL
240 mm

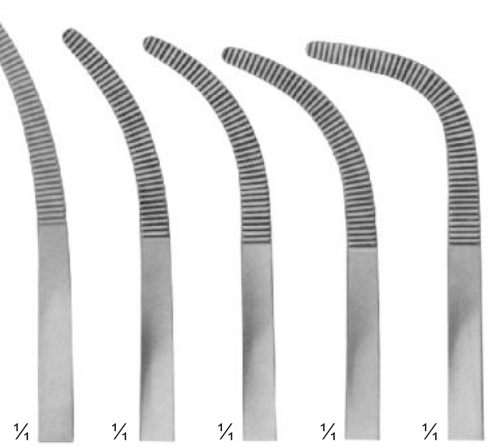

AS-09-315 AS-09-316 AS-09-317 AS-09-318 AS-09-319

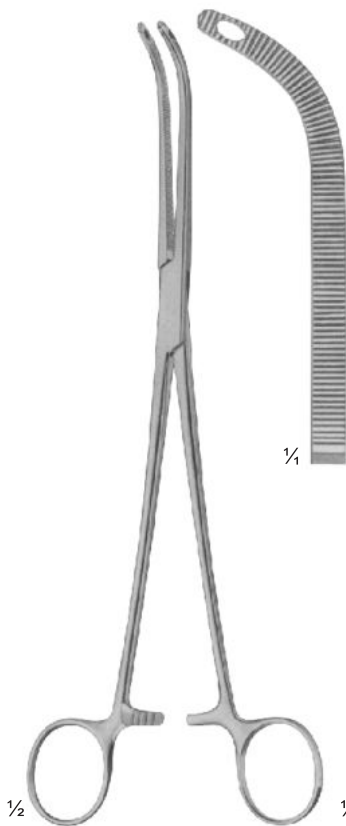

AS-09-320 FINOCHIETTO
245 mm

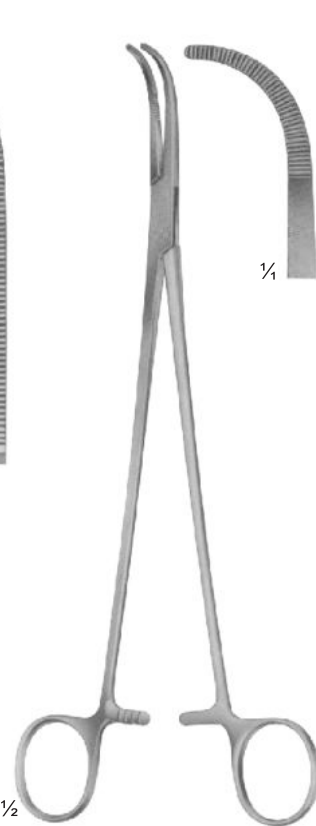

AS-09-321 MIXTER
230 mm



AS-09-322 LAWRENCE
270 mm

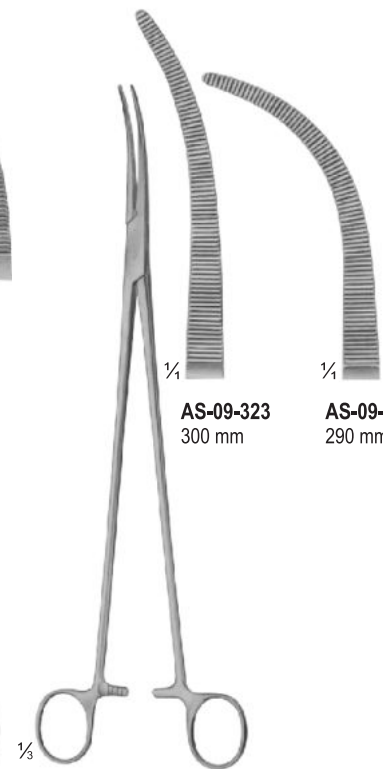

AS-09-323 - AS-09-324 ZENKER
270 mm

AS-09-323
300 mm

AS-09-324
290 mm



$\frac{1}{4}$
AS-09-325
180 mm

$\frac{1}{2}$
AS-09-325
LOWER



$\frac{1}{4}$ $\frac{1}{4}$
AS-09-326 AS-09-327
190 mm 220 mm

$\frac{1}{2}$
AS-09-326 - AS-09-327
LAHEY (SWEET)

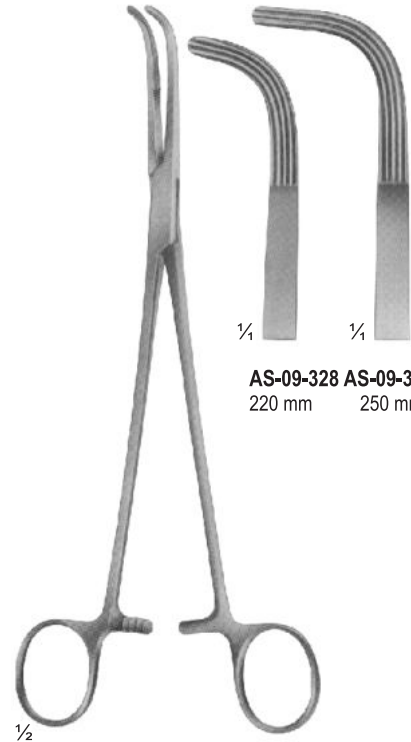

$\frac{1}{4}$ $\frac{1}{4}$
AS-09-328 AS-09-329
220 mm 250 mm

$\frac{1}{2}$
AS-09-328 - AS-09-329
MIXTER

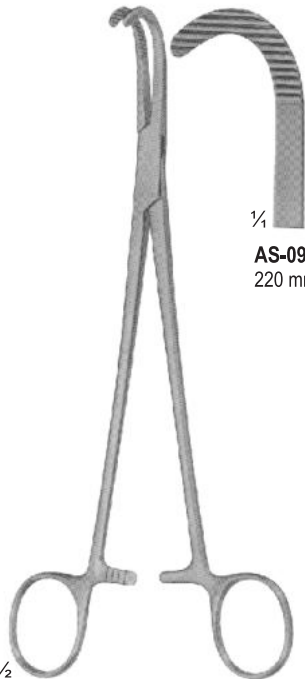

$\frac{1}{4}$
AS-09-330
220 mm

$\frac{1}{2}$
AS-09-330
DESJARDINS

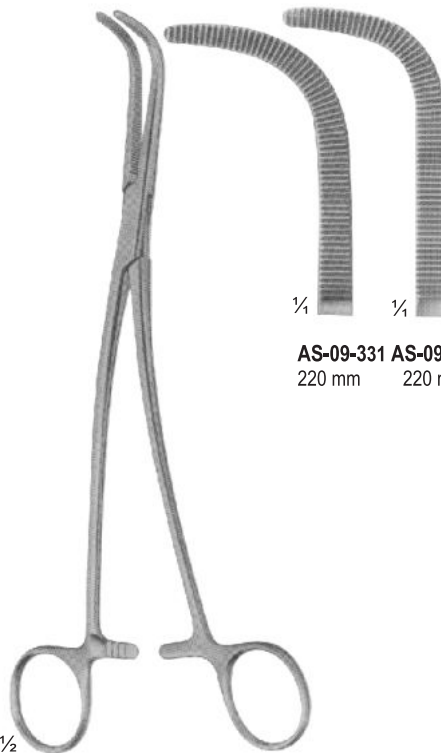

$\frac{1}{4}$ $\frac{1}{4}$
AS-09-331 AS-09-332
220 mm 220 mm

$\frac{1}{2}$
AS-09-331 - AS-09-332
GRAY

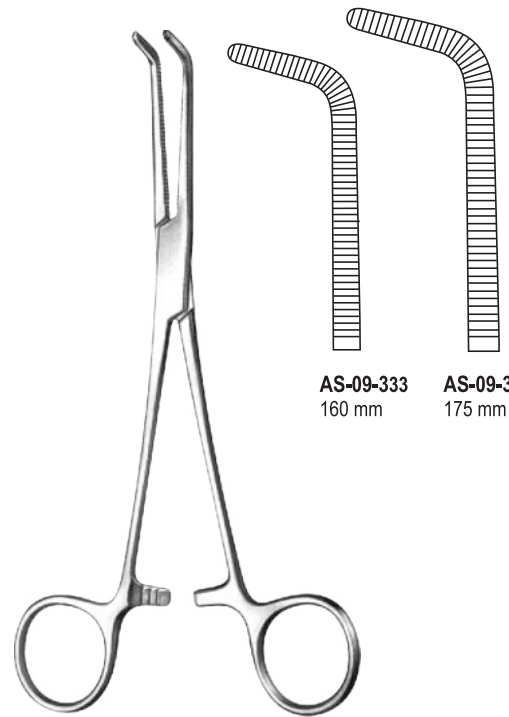

AS-09-333 AS-09-334
160 mm 175 mm

MIXTER
AS-09-333 - AS-09-334

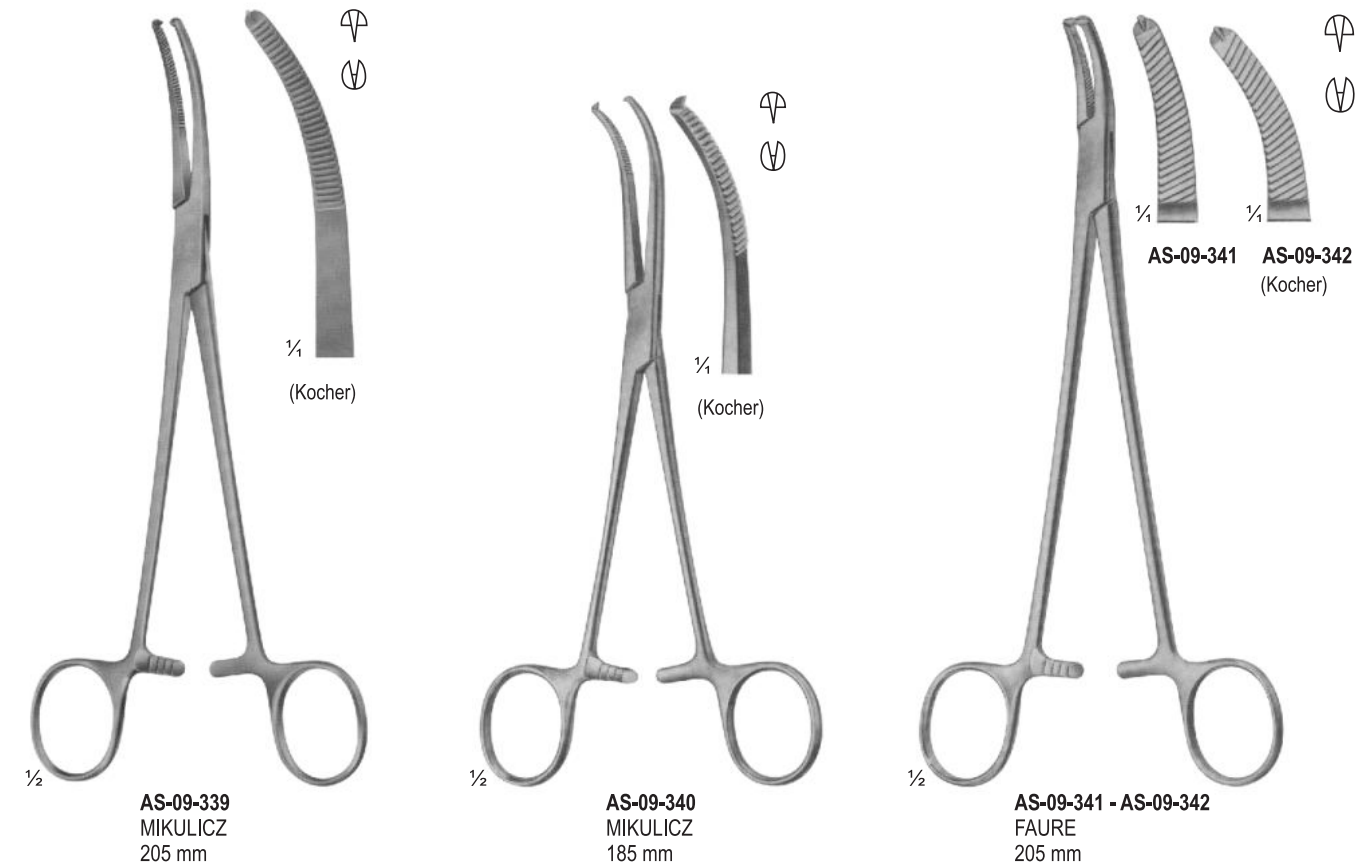
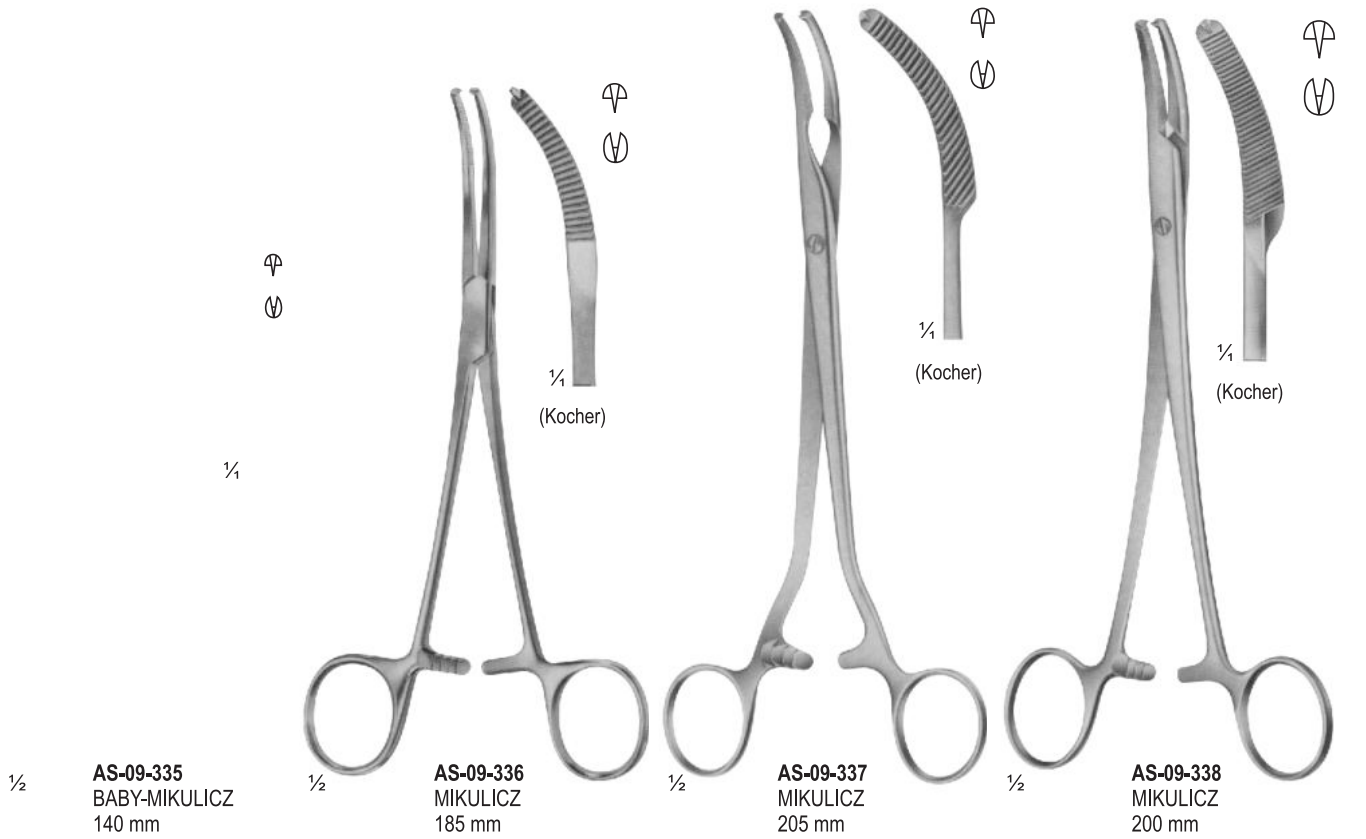

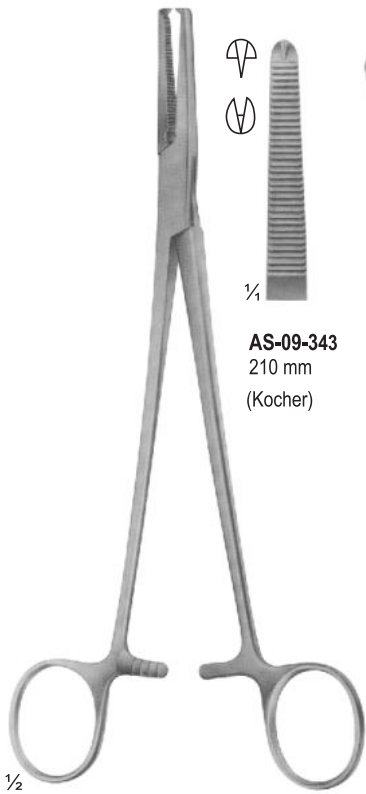

1/4

AS-09-343
210 mm
(Kocher)



1/4

AS-09-344
205 mm
(Kocher)

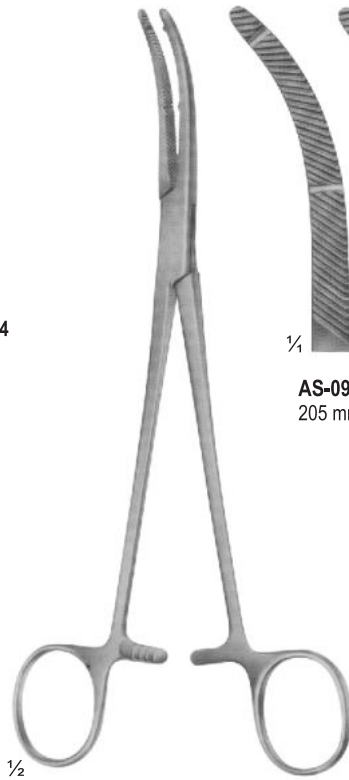

1/4

AS-09-345
205 mm

1/4

AS-09-346
245 mm

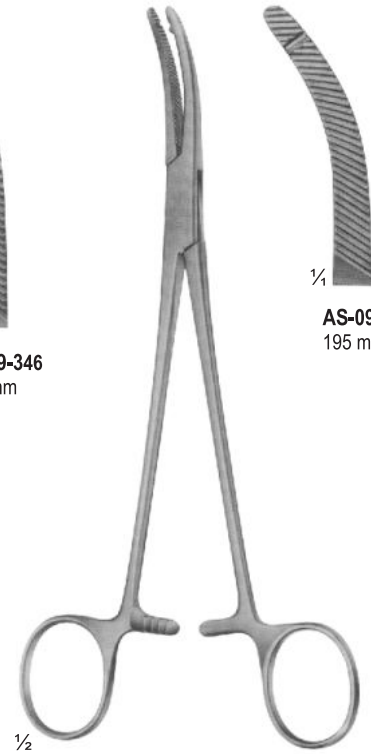

1/4

AS-09-347
195 mm

AS-09-343 - AS-09-344
PHANEUF

AS-09-345 - AS-09-346
HEANEY modif.

AS-09-347
HEANEY

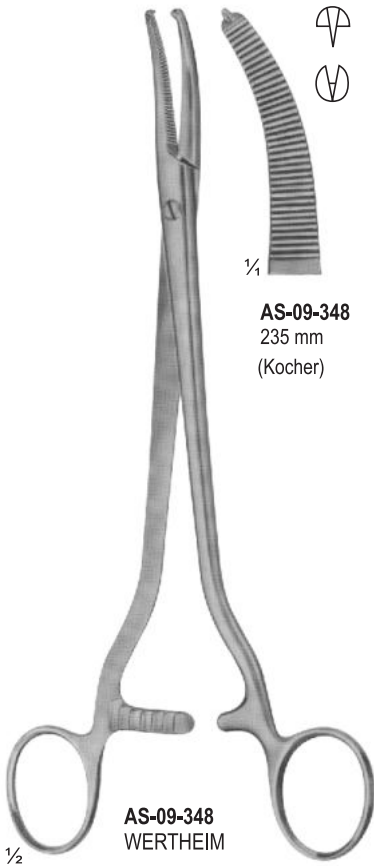

1/4

AS-09-348
235 mm
(Kocher)

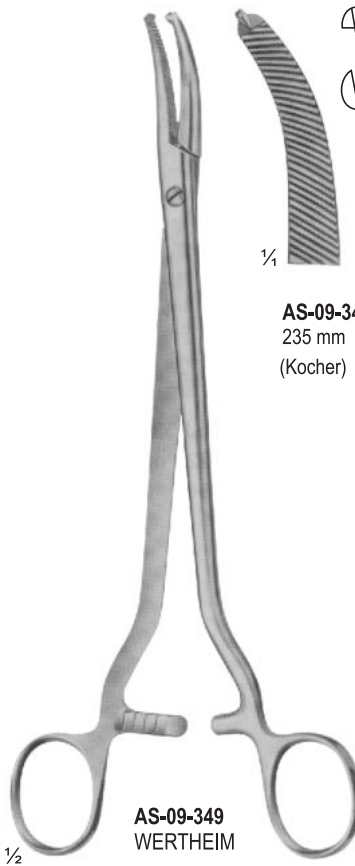

1/4

AS-09-349
235 mm
(Kocher)

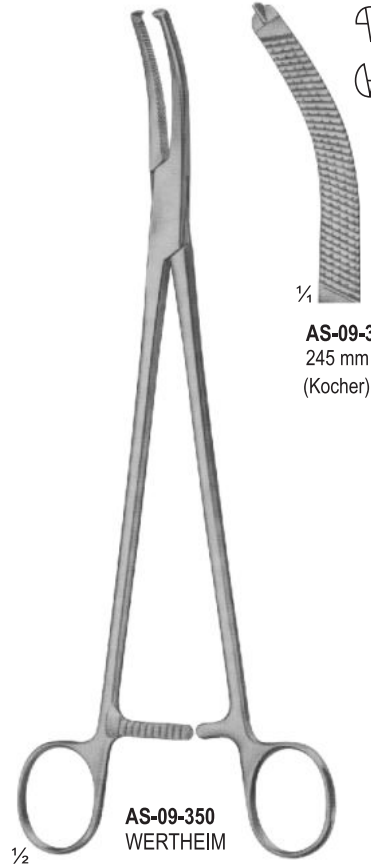

1/4

AS-09-350
245 mm
(Kocher)

AS-09-348
WERTHEIM

AS-09-349
WERTHEIM

AS-09-350
WERTHEIM

HYSTERECTOMY FORCEPS AND VAGINAL CLAMPS



AS-09-351
225 mm



AS-09-352
220 mm



AS-09-353
215 mm

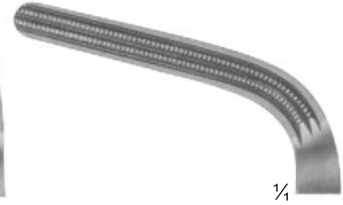

AS-09-354
205 mm



AS-09-355
250 mm



AS-09-356
245 mm



AS-09-357
240 mm

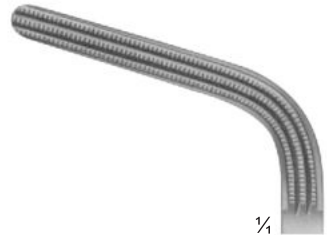

AS-09-358
220 mm

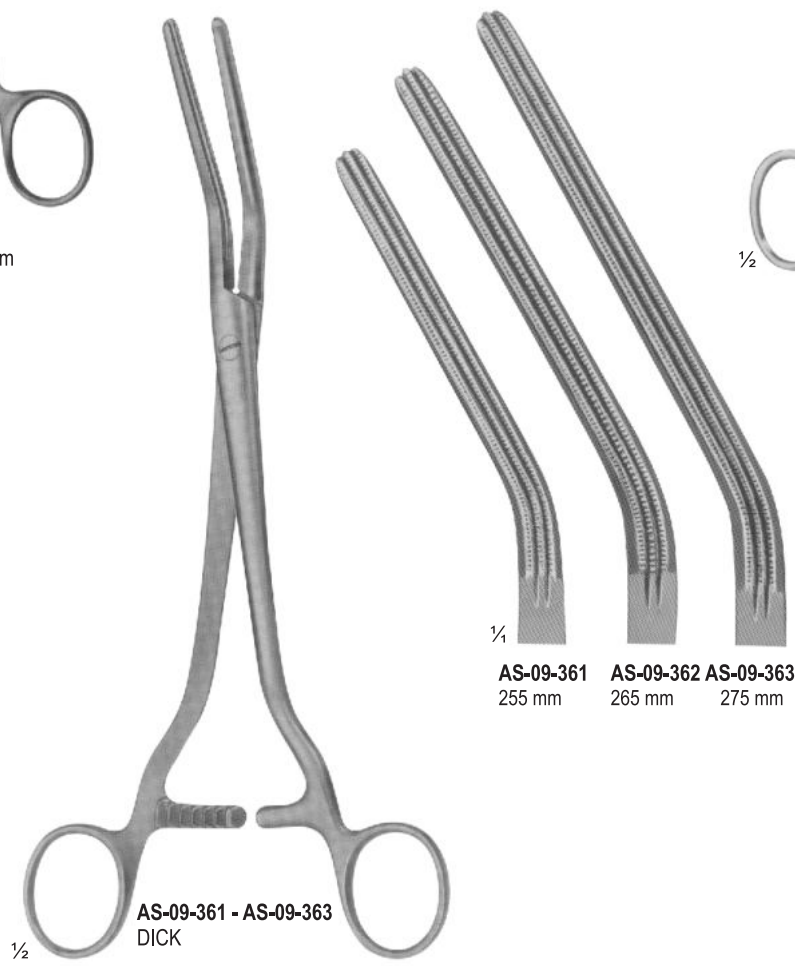
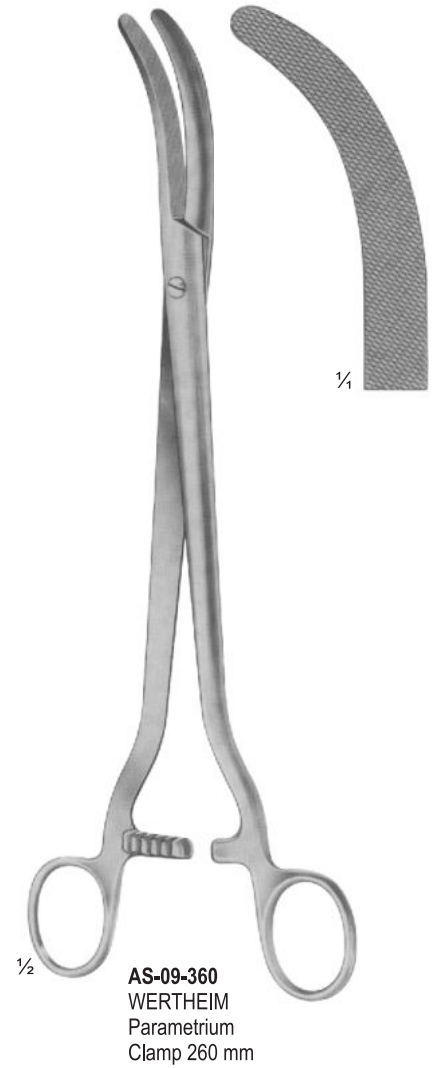
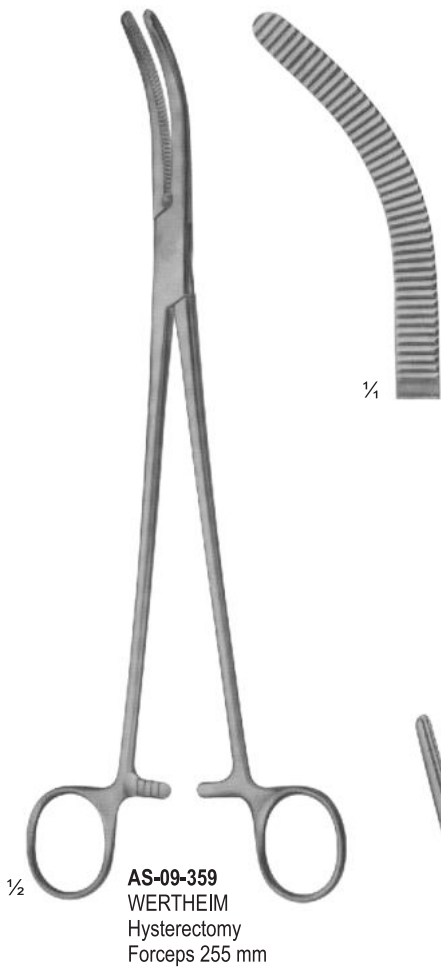

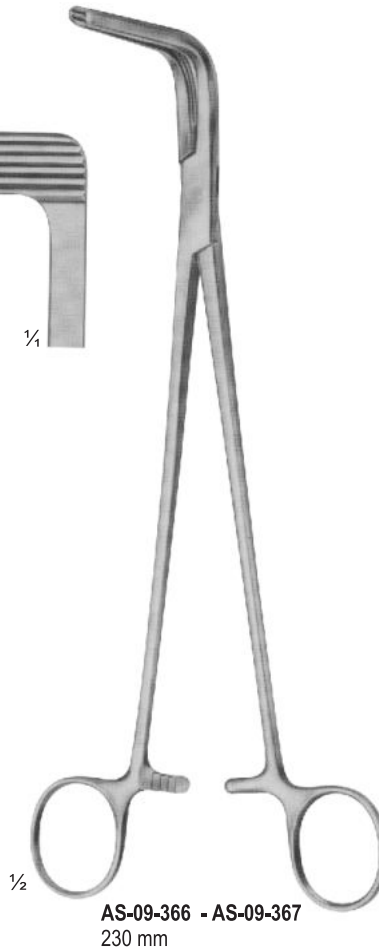
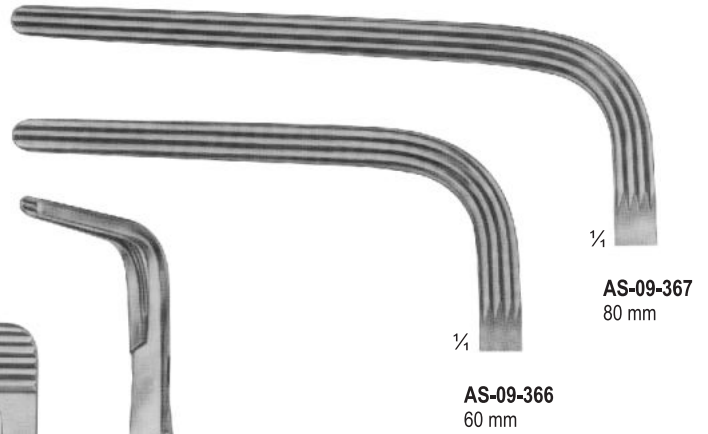
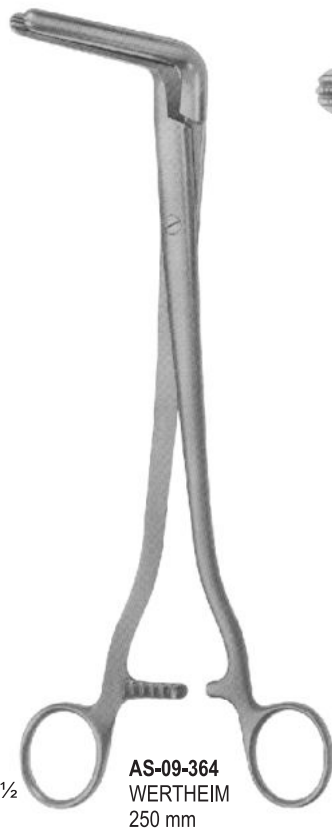

DELICATE HAEMOSTATIC FORCEPS



ASAMAR
SURGICAL

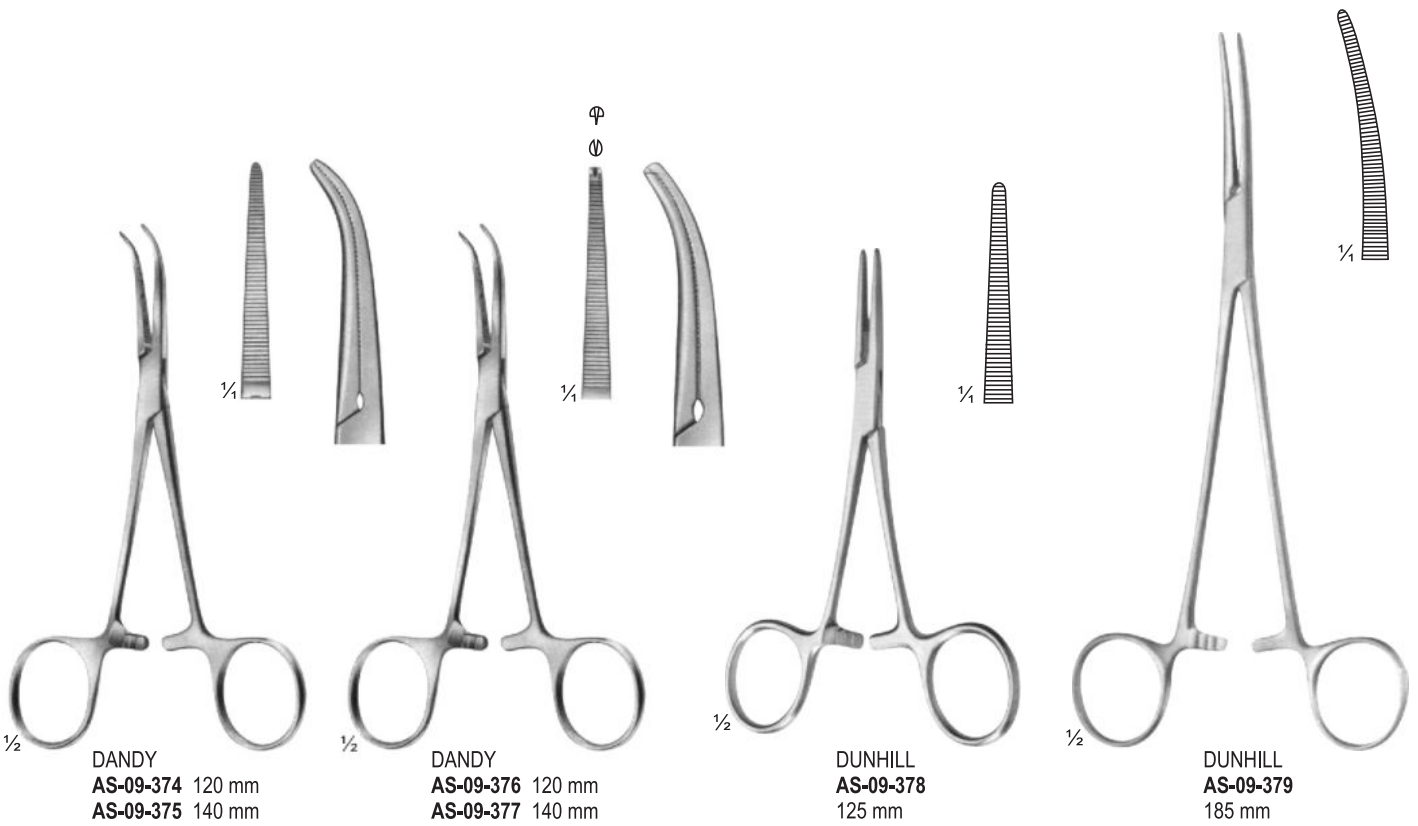
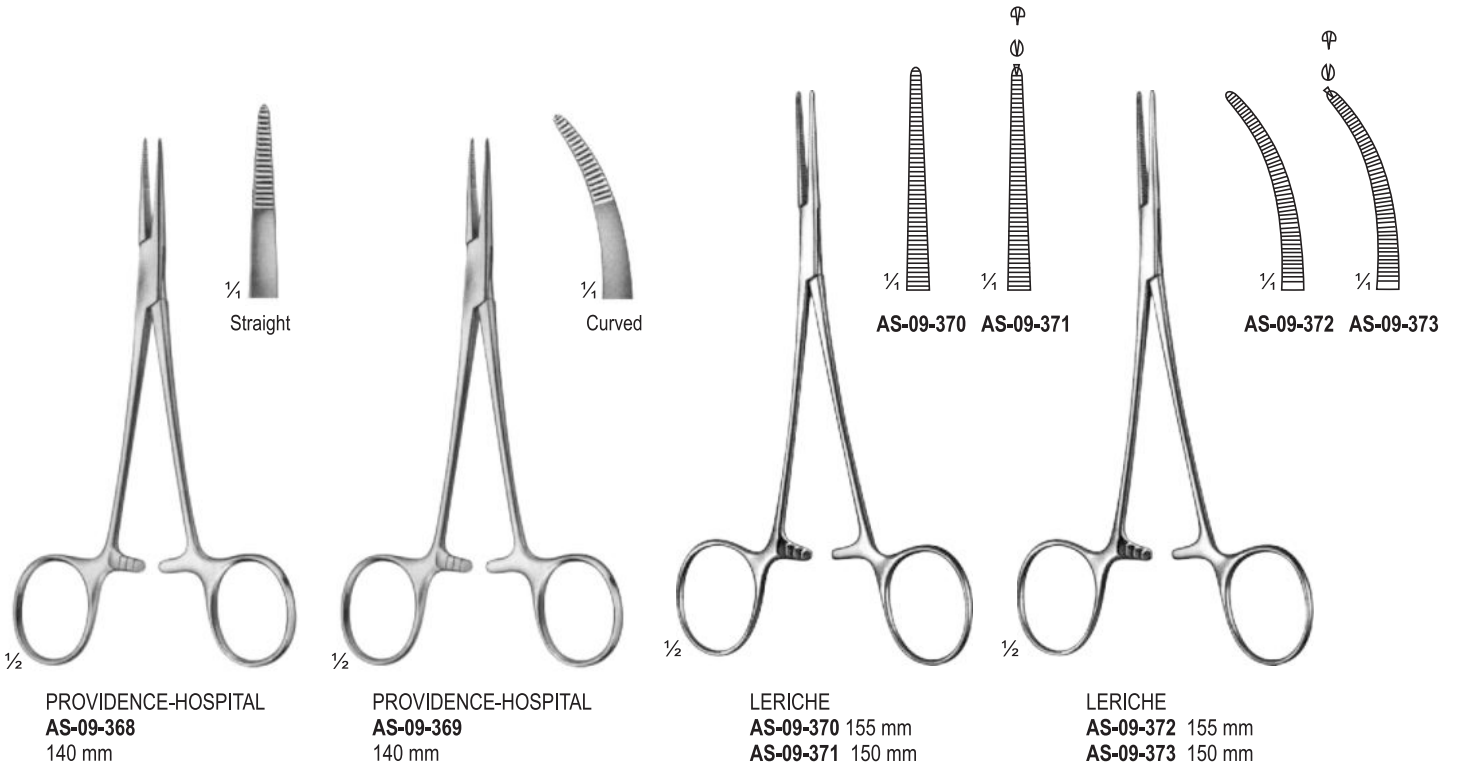

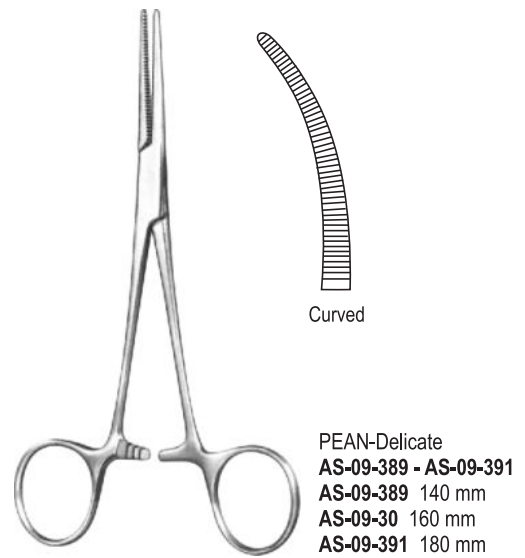
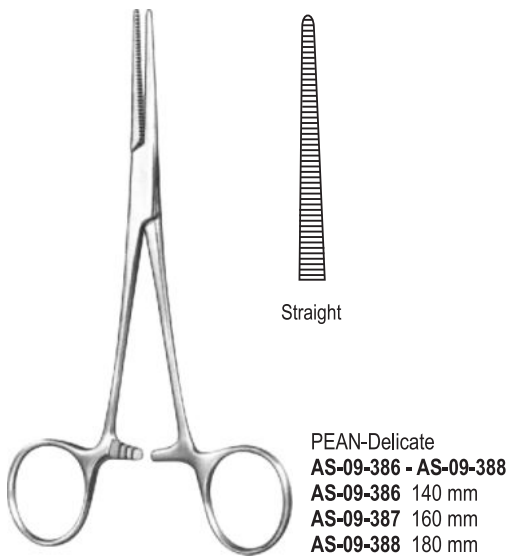
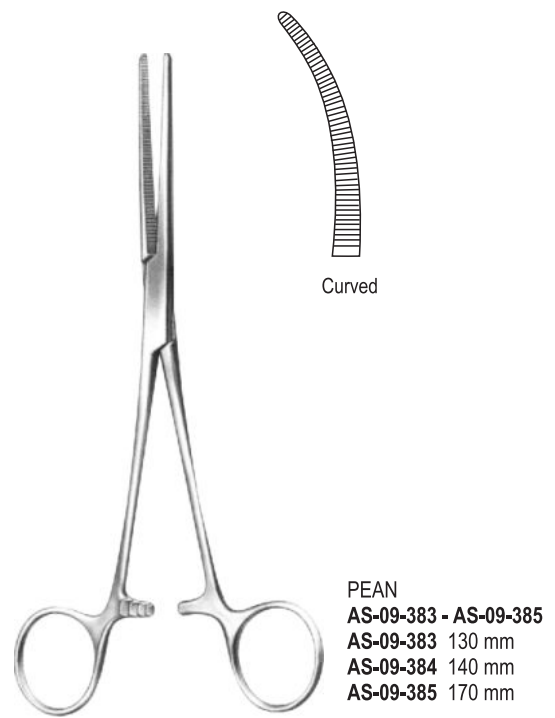
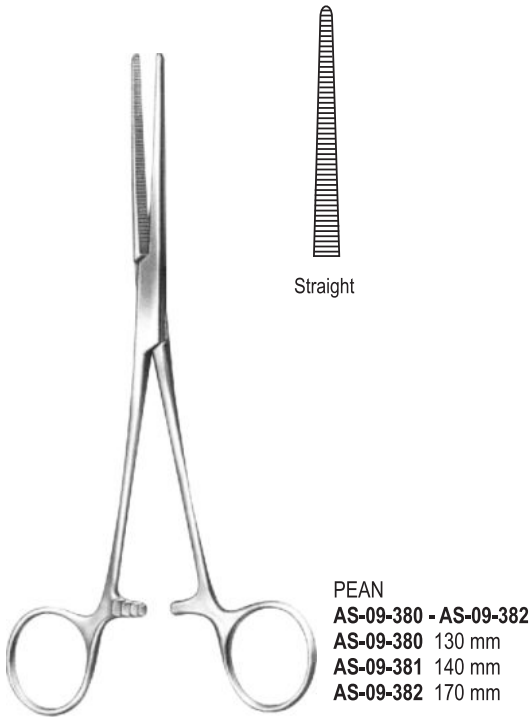

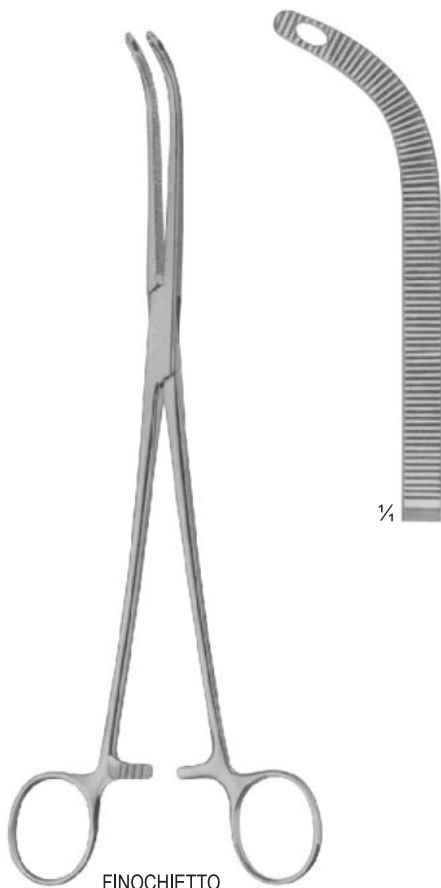

FINOCHIETTO
AS-09-392
245 mm

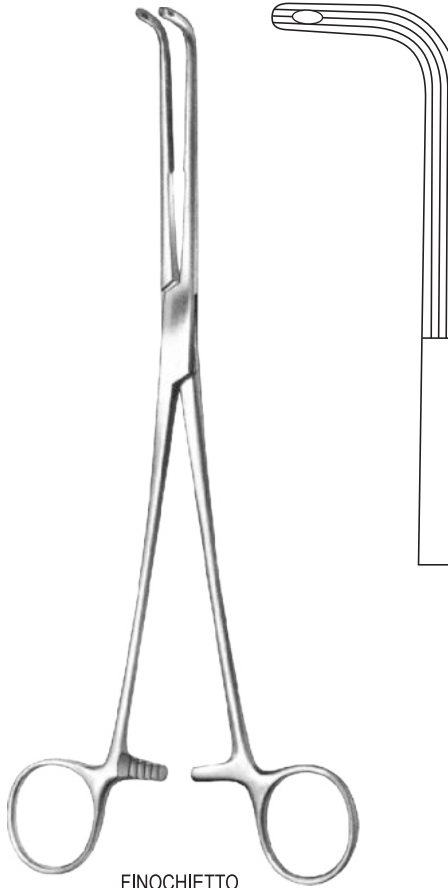

FINOCHIETTO
AS-09-393
245 mm

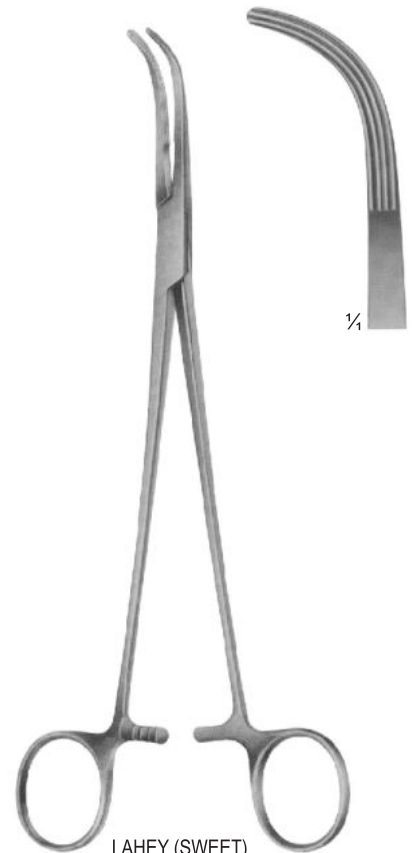

LAHEY (SWEET)
AS-09-34 190 mm
AS-09-395 230 mm

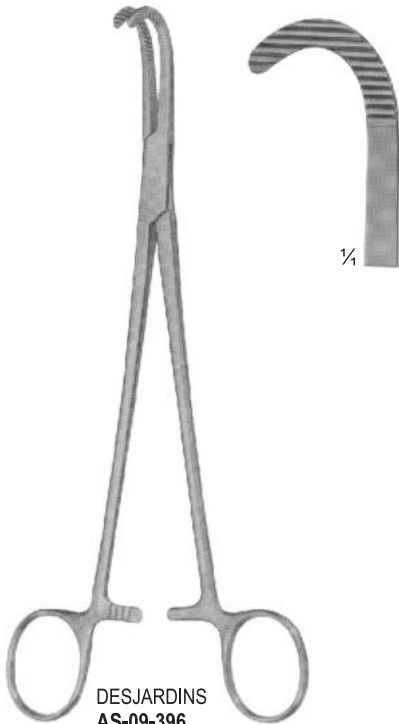

DESJARDINS
AS-09-396
210 mm



LOWER
AS-09-397
180 mm

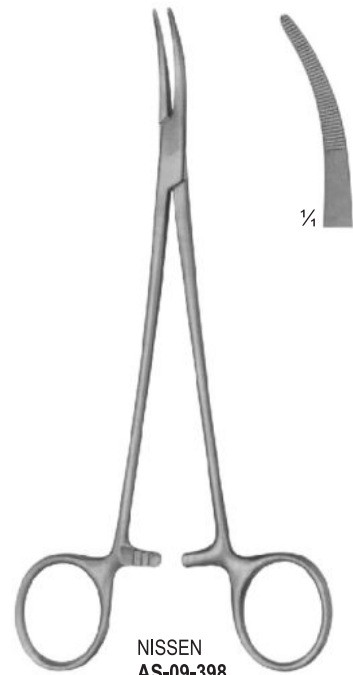

NISSEN
AS-09-398
180 mm

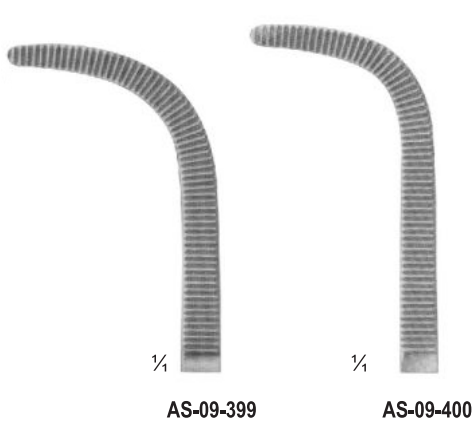

GRAY
AS-09-399 - AS-09-300
220 mm

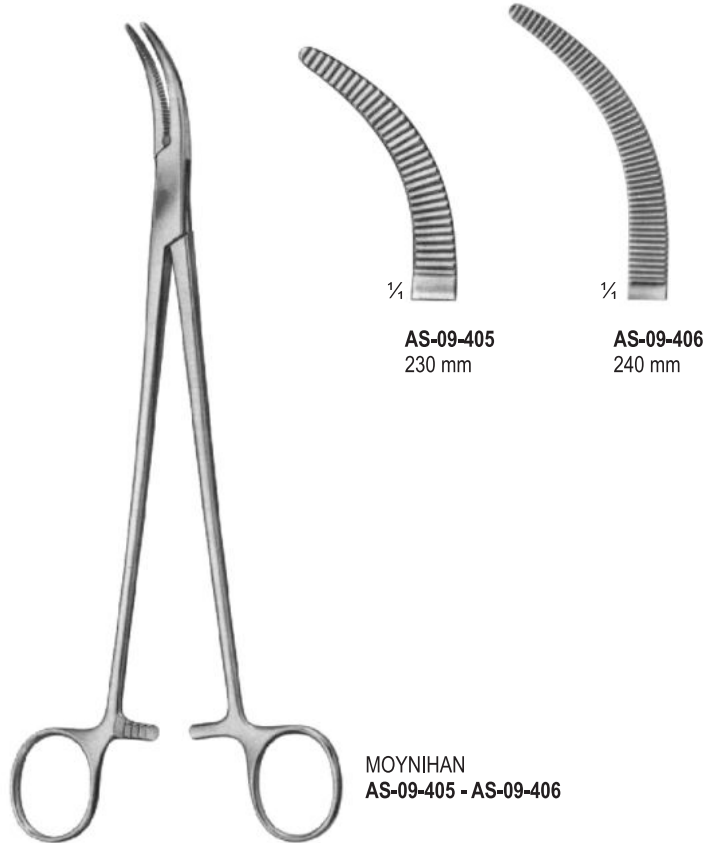
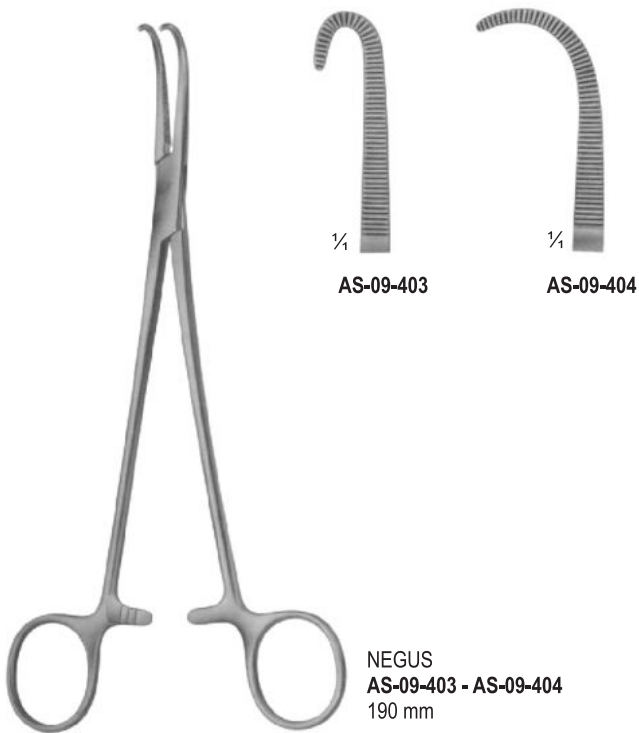
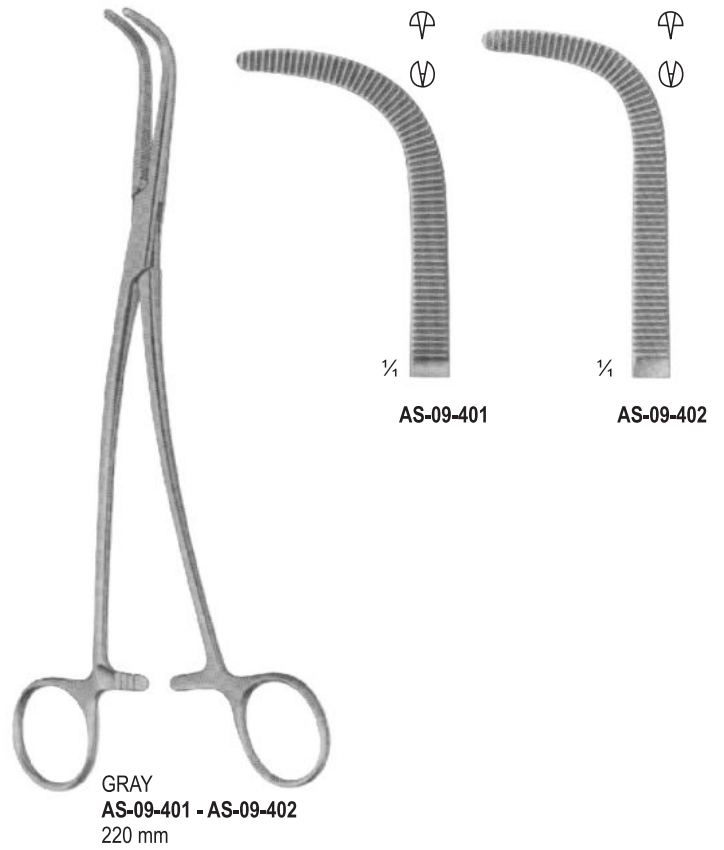

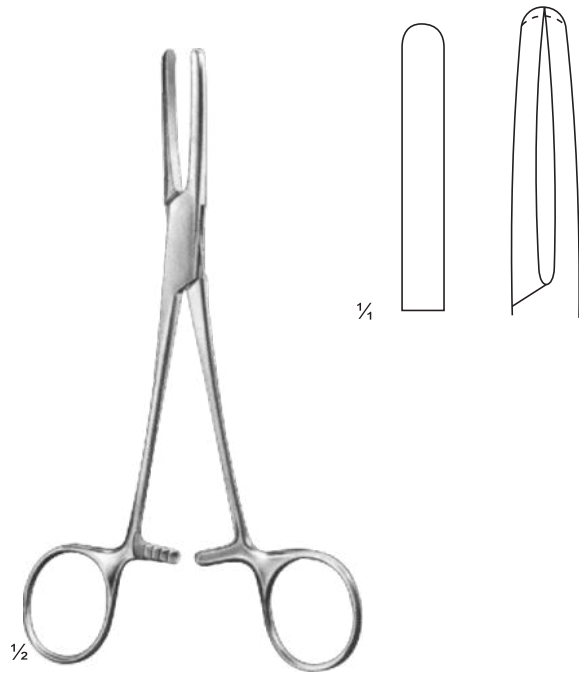

AS-09-407
16.5 cm

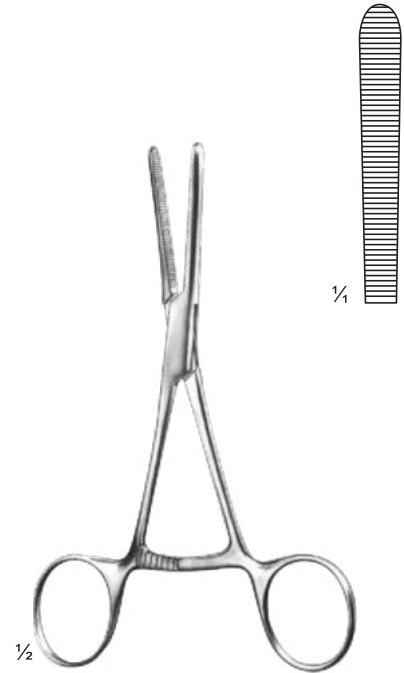

AS-09-408
14 cm

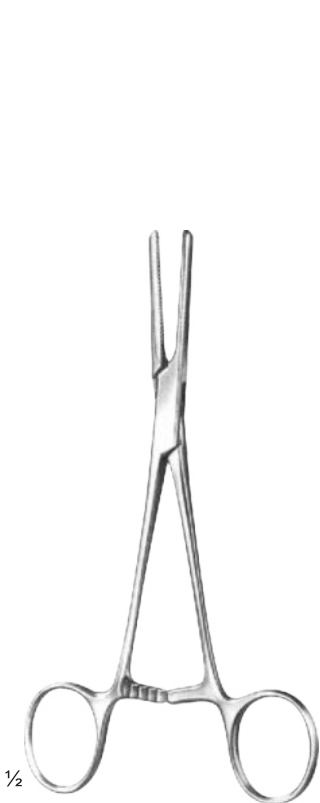

AS-09-409 - AS-09-410

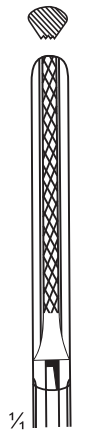

AS-09-409
190 mm



AS-09-410
205 mm

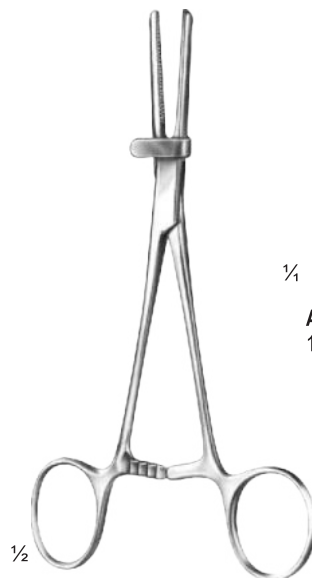

AS-09-411 - AS-09-413

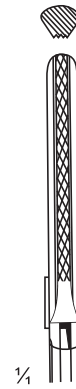

AS-09-411
155 mm



AS-09-412
190 mm

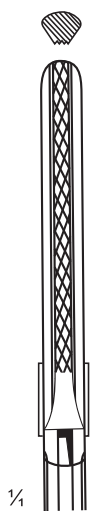

AS-09-413
205 mm

HYSTERECTOMY FORCEPS AND VAGINAL CLAMPS

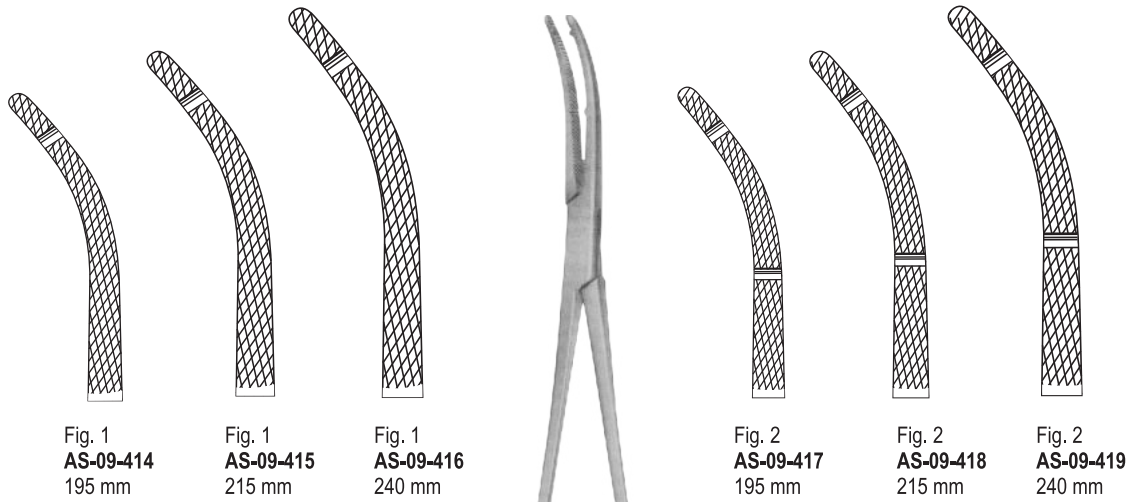

$\frac{1}{2}$ HEANEY
AS-09-414 - AS-09-416



$\frac{1}{2}$ PHANEUF
AS-09-420 210 mm
AS-09-421 200 mm

$\frac{1}{2}$ HEANEY
AS-09-417 - AS-09-419



$\frac{1}{2}$ PHANEUF
AS-09-422 210 mm
AS-09-423 200 mm

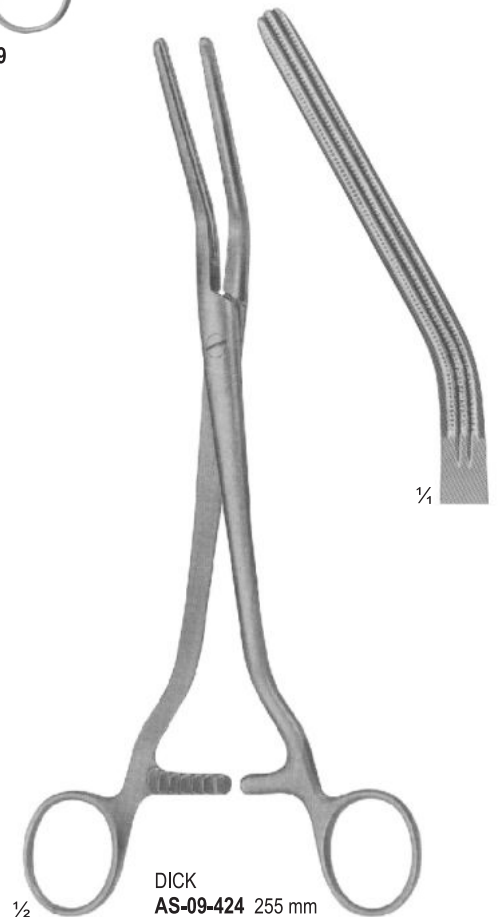

$\frac{1}{2}$ DICK
AS-09-424 255 mm
AS-09-425 265 mm
AS-09-426 275 mm



ASAMAR
SURGICAL 

PAGE
186-222
ENT SURGERY



¼

ZÖLLNER
AS-10-101 - AS-10-1006 set
for adults, black



AS-10-101
Fig.1
5.5 X 6.5 mm



AS-10-102
Fig.2
6.5 X 7.5 mm



AS-10-103
Fig.3
7.5 X 8.5 mm



AS-10-104
Fig.4
8.5 X 9.5 mm



AS-10-105
Fig.5
9.5 X 10.5 mm



AS-10-106
Fig.6
10.5 X 11.5 mm



¼

POLITZER
AS-10-107 - AS-10-110
set for adults



AS-10-107
Fig.1
2 mm Ø



AS-10-108
Fig.2
3 mm Ø



AS-10-109
Fig.3
4 mm Ø



AS-10-110
Fig.4
5 mm Ø



¼

BOUCHERON
AS-10-111 - AS-10-113
set for children



AS-10-111
Fig.0
3.0 mm Ø



AS-10-112
Fig.1
4.5 mm Ø



AS-10-113
Fig.2
5.5 mm Ø



¼

HARTMANN
AS-10-114 - AS-10-117
set for adults



AS-10-114
Fig.1
4.5 mm Ø



AS-10-115
Fig.2
5.5 mm Ø



AS-10-116
Fig.3
6.5 mm Ø



AS-10-117
Fig.4
7.5 mm Ø



BUCK
AS-10-118 - AS-10-133
Blunt Sharp
165 mm - 6½"



AS-10-118
Fig.000



AS-10-119
Fig.00



AS-10-120
Fig.0



AS-10-121
Fig.1



AS-10-122
Fig.2



AS-10-123
Fig.3



AS-10-124
Fig.4



AS-10-125
Fig.5



AS-10-126
Fig.000



AS-10-127
Fig.00



AS-10-128
Fig.0



AS-10-129
Fig.1



AS-10-130
Fig.2



AS-10-131
Fig.3



AS-10-132
Fig.4



AS-10-133
Fig.5



BUCK
AS-10-134 - AS-10-149
Curved, blunt
Curved, sharp
165 mm - 6½"



AS-10-134
Fig.000



AS-10-135
Fig.00



AS-10-136
Fig.0



AS-10-137
Fig.1



AS-10-138
Fig.2



AS-10-139
Fig.3



AS-10-140
Fig.4



AS-10-141
Fig.5



AS-10-142
Fig.000



AS-10-143
Fig.00



AS-10-144
Fig.0



AS-10-145
Fig.1



AS-10-146
Fig.2



AS-10-147
Fig.3



AS-10-148
Fig.4



AS-10-149
Fig.5

Picture Show The Outer Diameter

EAR CURETTES AND SHARP SPOONS



ASAMAR
SURGICAL

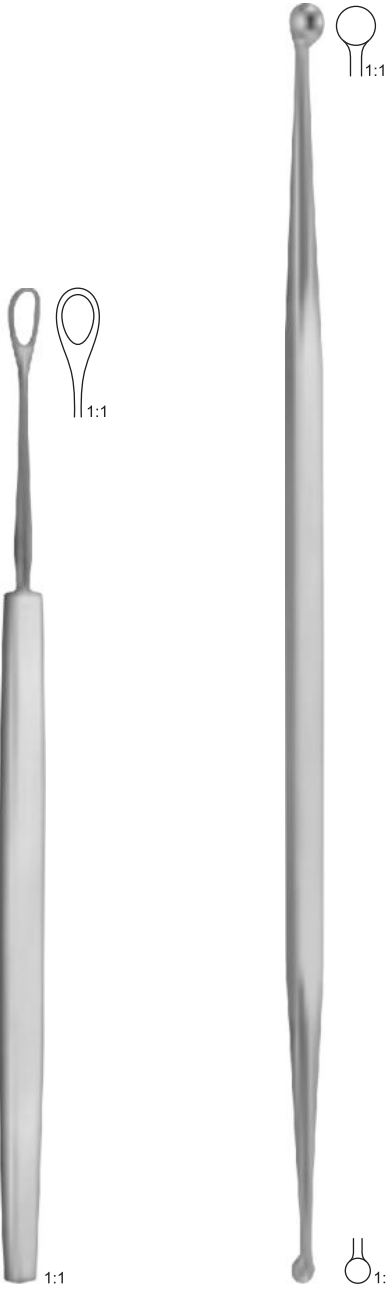

LANGENBECK
AS-10-150
Blunt
130 mm - 5"

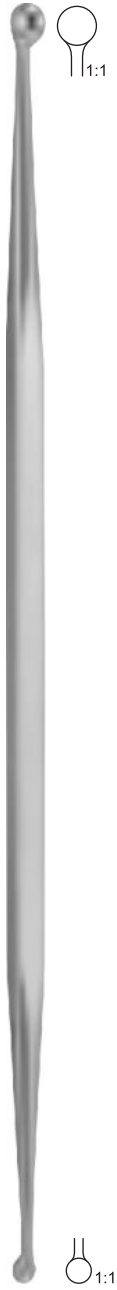

JANSEN
AS-10-151
Sharp
170 mm - 6
3/4"



GROSS
AS-10-152
Sharp, not fenestrated
120 mm - 4 3/4"



AS-10-153
Blunt, fenestrated
120 mm - 4 3/4"



JANSEN
AS-10-154
Sharp
160 mm - 6
1/4"



BILLEAU
AS-10-155 - AS-10-157
165 mm - 6½"

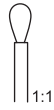

AS-10-155

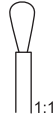

AS-10-156



AS-10-157



LUCAE
AS-10-158 - AS-10-160
140 mm - 5½"



AS-10-158



AS-10-159



AS-10-160



WAGENER
AS-10-161 - AS-10-167
140 mm - 5½"



AS-10-161



AS-10-162



AS-10-163



AS-10-164



AS-10-165



AS-10-166



AS-10-167



1:2



POLITZER
AS-10-168
150 mm -
6"



GERZOG
AS-10-169
160 mm - 6
1/4"



BUCK
AS-10-170
160 mm - 6
1/4"



1:2

1:1

LUCAE
AS-10-171
180 mm -
7"



1:2

1:1

LUCAE
AS-10-172
180 mm -
7"



1:2



LUCAE
AS-10-173
190 mm -
7 1/2"



1:2



POLITZER
AS-10-174
170 mm - 7
3/4"



1:2



1:2



AS-10-176
Needle
horizontal 160
mm - 6 1/4"

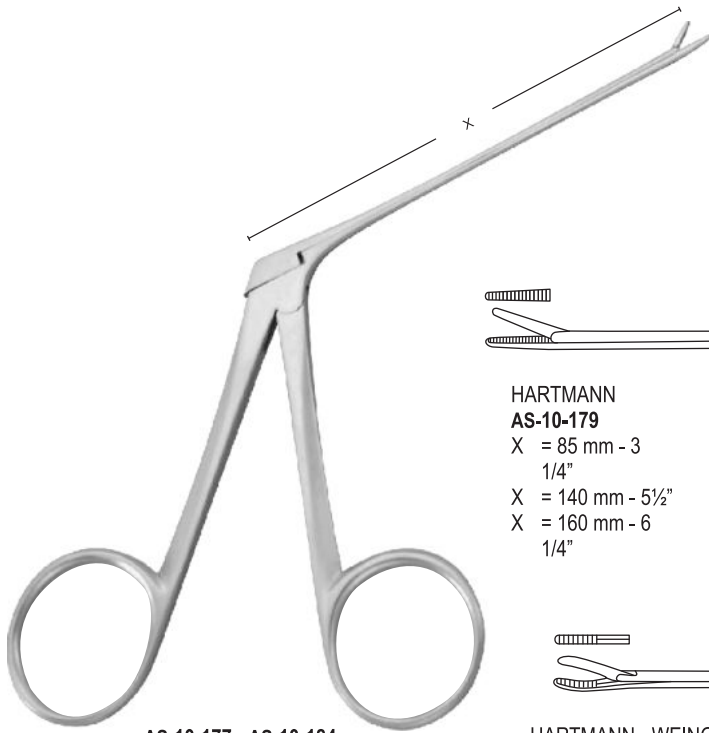

AS-10-177 - AS-10-184

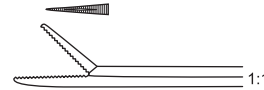

HARTMANN - WULLSTEIN
AS-10-177
X = 85 mm - 3 1/4"



HARTMANN - WULLSTEIN
AS-10-178
X = 85 mm - 3 1/4" 1 mm ϕ



HARTMANN
AS-10-179
X = 85 mm - 3 1/4"
X = 140 mm - 5 1/2"
X = 160 mm - 6 1/4"

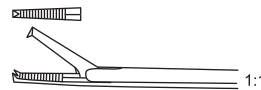

HARTMANN
AS-10-180
X = 85 mm - 3 1/4"
X = 140 mm - 5 1/2"

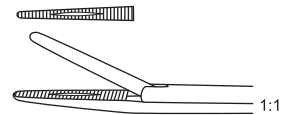

HARTMANN - NOYES
AS-10-181
X = 90 mm - 3 1/2"



HARTMANN - WEINGARTNER
AS-10-182
X = 85 mm - 3 1/4"



HARTMANN
AS-10-183
X = 85 mm - 3 1/4"
2.0 mm ϕ
2.5 mm ϕ
3.0 mm ϕ



STRUEMPEL
AS-10-184
X = 85 mm - 3 1/4"

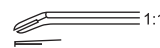

MCGEE
AS-10-185
wire bending
forceps 3.5 mm X
0.8 mm



FULLER
AS-10-186
introducing forceps
for teflon
prosthesis 80 mm -
3 1/4"

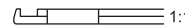

AS-10-187
Up - cutting

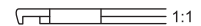

AS-10-188
Down - cutting



AS-10-189
Right - cutting



AS-10-190
Left - cutting

DIETER
AS-10-185 - AS-10-190
malleus nipper
X = 80 mm - 3 1/4"



AS-10-191 - AS-10-195

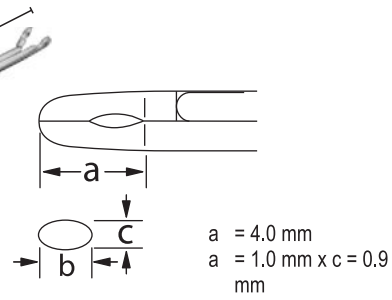

AS-10-191
Straight, oval
X = 75 mm - 3"



AS-10-192
Curved upwards,
oval X = 75 mm - 3"



AS-10-193
Curved to left,
oval X = 75 mm - 3"



AS-10-194
Curved to right,
oval X = 75 mm - 3"



AS-10-195
Curved downwards, oval
X = 75 mm - 3"

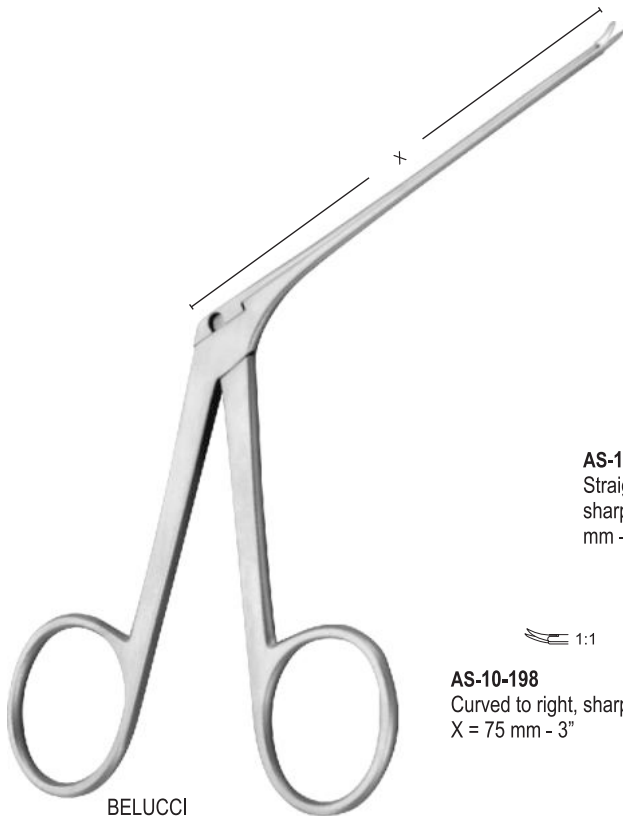

BELUCCI
AS-10-196 - AS-10-200

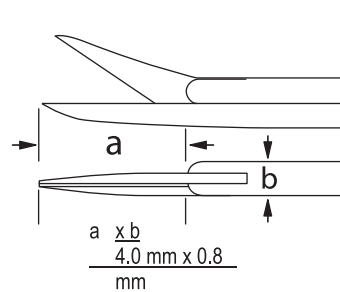

AS-10-196
Straight,
sharp/sharp X = 75
mm - 3"



AS-10-197
Curved upwards,
blunt/blunt X = 75 mm - 3"



AS-10-198
Curved to right, sharp/sharp
X = 75 mm - 3"



AS-10-199
Curved to left,
sharp/sharp X = 75 mm - 3"



AS-10-200
straight,
sharp/blunt
X = 75 mm - 3"



1:1
PLESTER
AS-10-201 - AS-10-206
160 mm - 6 1/4"



1:1
WIRE GUIDE
AS-10-201



1:1
RASPATORY
AS-10-202



1:1
RASPATORY
AS-10-203
1.8 mm



1:1
AS-10-204
Dissector, double
curved right



1:1
AS-10-205
Instrument for
placing wire prothesis



1:1
AS-10-206
Dissector, double
curved left



ROSEN
AS-10-207 - AS-10-213
160 mm - 6 1/4"



1:1
AS-10-207
Circular cutting
knife 1.5 \varnothing mm - 90



1:1
AS-10-208
Tympanum
knife 45

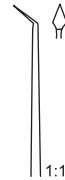

1:1
AS-10-209
Lancet
knife 45



1:1
AS-10-210
Lancet knife



1:1
RASPATORY
AS-10-211
Zollner
1 mm



1:1
AS-10-212
Sickle knife,
slightly
curved



1:1
AS-10-213
discision knife,
straight
curved



1:1
AS-10-214 - AS-10-219



AS-10-214
Needle fine, straight,
sharp 160 mm - 6 1/4"



AS-10-215
Needle, slightly curved,
sharp 160 mm - 6 1/4"

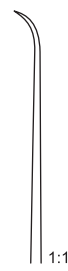

AS-10-216
Needle, strong curved,
sharp 160 mm - 6 1/4"

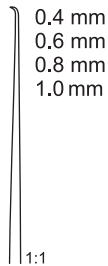

**SHAMBAUGH
AS-10-217**
45° Hook, angled
160 mm - 6 1/4"



**PLESTER
AS-10-218**
0.4 mm - 90°
foot plate hook, angled,
blunt 160 mm - 6 1/4"



**PLESTER
AS-10-219**
0.4 mm - 45°
Antrum hook, angled,
blunt 160 mm - 6 1/4"



1:1
AS-10-220 - AS-10-223



**FISCH
AS-10-220**
Angled to the right
155 mm - 6"



AS-10-221
Angled to the
left 155 mm - 6"

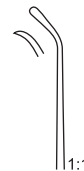

AS-10-222
Angled to the right
155 mm - 6"



AS-10-223
Angled to the left
155 mm - 6"



HOUSE
AS-10-224
spoon, strong curved
spoon, slightly
curves 170 mm - 6
3/4"



SHEA
AS-10-225
straight
160 mm - 6 1/4"
1.5 mm X 2.5
mm



SHEA
AS-10-226
curved
160 mm - 6 1/4"
1.5 mm X 2.5
mm







1:2
CITELLI
AS-10-227 - AS-10-229
 X = 60 mm
 170 mm - 6 3/4"

- | | | |
|---|---|---|
| 
AS-10-227
1.5 mm | 
AS-10-228
2.2 mm | 
AS-10-229
3.0 mm |
|---|---|---|



1:2
AS-10-230 - AS-10-233
 200 mm - 8"
 X = 80 mm

- | | |
|---|---|
| 
AS-10-230
3 X 3 mm | 
AS-10-231
4 X 4 mm |
| 
AS-10-232
5 X 5 mm | 
AS-10-233
6 X 6 mm |

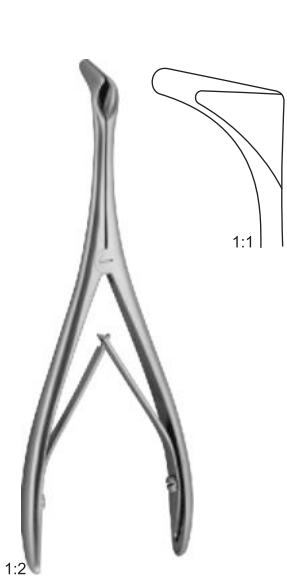

1:2
TIECK - HALLE
AS-10-234
 for babies
 135 mm - 5
 1/4"



1:2
BECKMANN
AS-10-235
 150 mm - 6"



1:2
MOD. WIEN
AS-10-236
 145 mm - 5
 3/4"

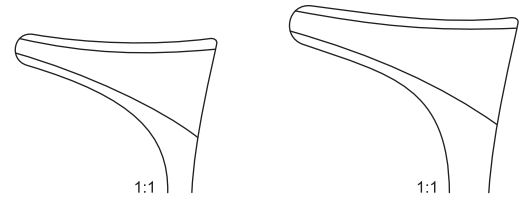

1:1

1:1

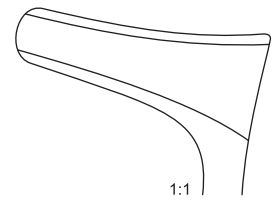

1:1



1:2
AS-10-237 - AS-10-240
KILLIAN
 130 mm - 5"

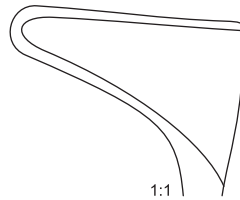

1:1

AS-10-237
 X = 35 mm

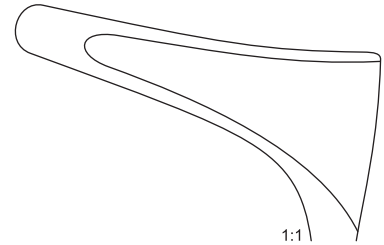

1:1

AS-10-238
 X = 50 mm

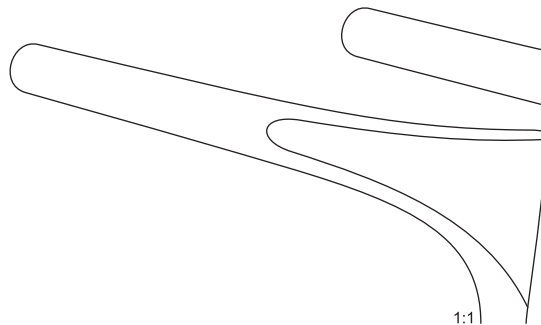

1:1

AS-10-239
 X = 75 mm

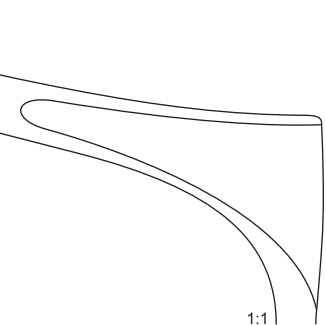

1:1

AS-10-240
 X = 90 mm

NASAL POLYPUS AND SEPTUM FORCEPS



WESTMACOTT
AS-10-241
200 mm - 8"

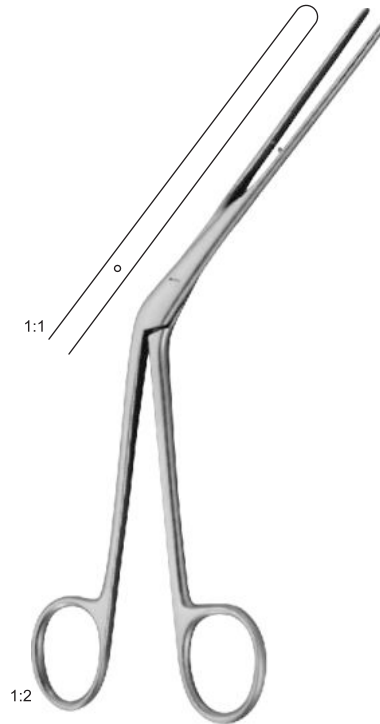

LUBET - BARBON
AS-10-242
200 mm - 8"



HARTMANN
AS-10-243
160 mm - 6
1/4" 200 mm - 8"

NASAL DRESSING FORCEPS

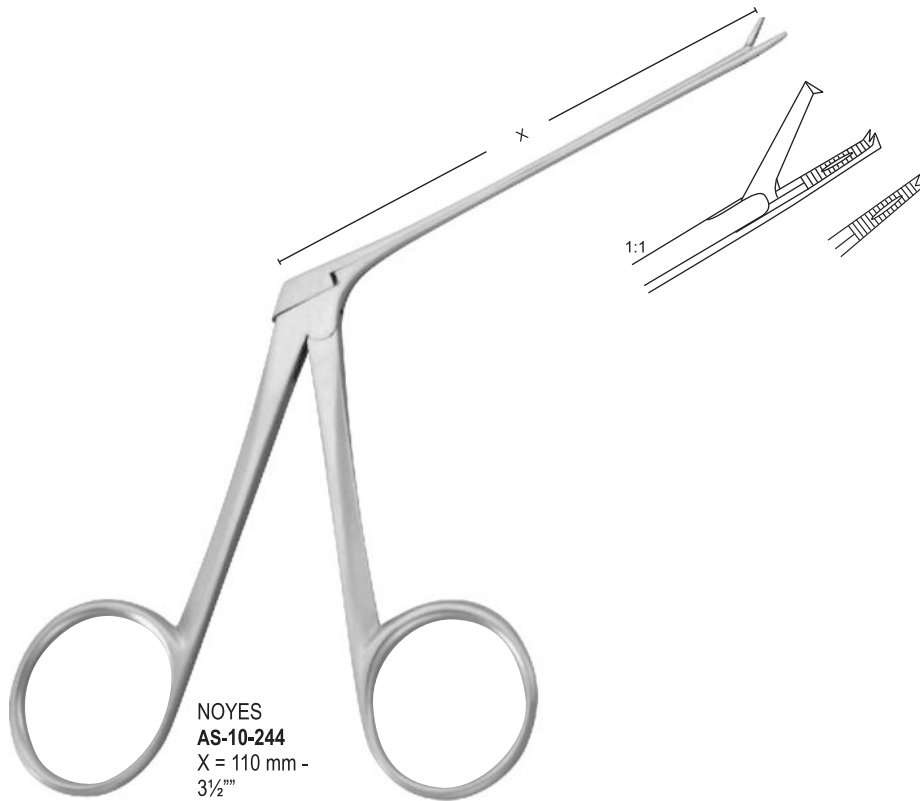

NOYES
AS-10-244
X = 110 mm - 3 1/2"

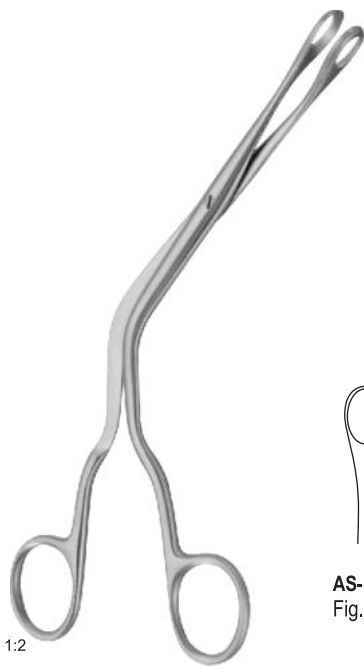

Fenestrated



AS-10-245
Fig.1

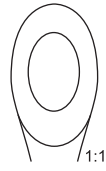

AS-10-246
Fig.2

Plain



AS-10-247
Fig.1



AS-10-248
Fig.2

1:2

LUC
AS-10-245 - AS-10-248
200 mm - 8"

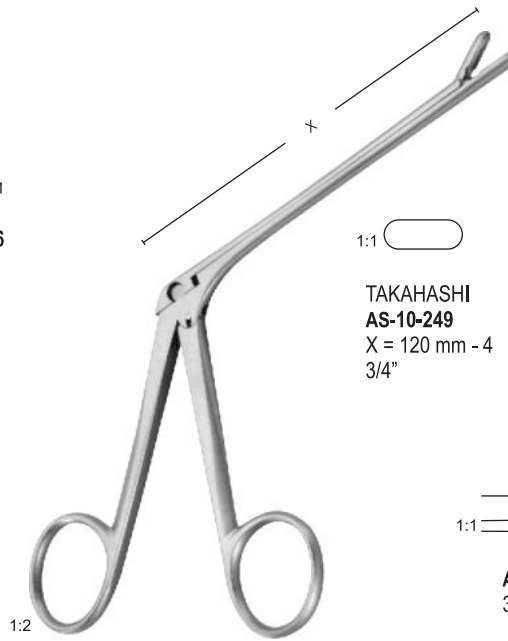

1:1

TAKAHASHI
AS-10-249
X = 120 mm - 4 3/4"

1:1

AS-10-250
3.5 mm X 10 mm

1:1

AS-10-251
3.5 mm X 10 mm

AS-10-249 - AS-10-251

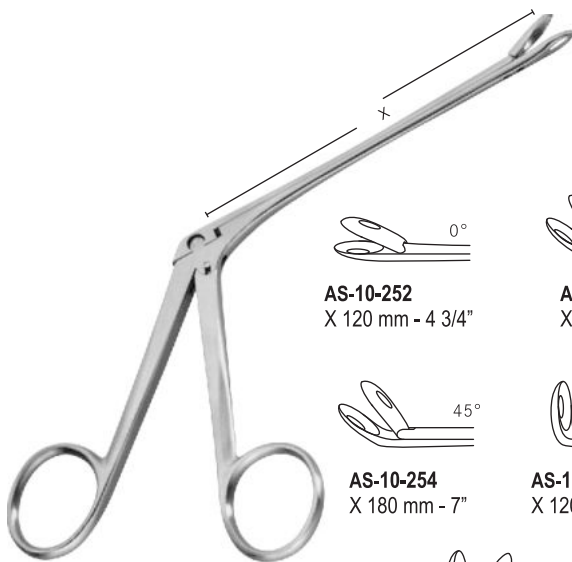

AS-10-252
X 120 mm - 4 3/4"



AS-10-253
X 120 mm - 4 3/4"



AS-10-254
X 180 mm - 7"



AS-10-255
X 120 mm - 4 3/4"

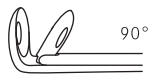

AS-10-256
X 180 mm - 7"

WEIL - BLAKESLEY
AS-10-252 - AS-10-256



HARTMANN



AS-10-257



AS-10-258



AS-10-259

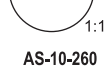

AS-10-260

MYLES



AS-10-261
Fig.1
2.0 X 10.0 mm



AS-10-262
Fig.2
2.5 X 12.0 mm



AS-10-263
Fig.3
3.0 X 14.0 mm

AS-10-257 - AS-10-263
X 120 mm - 4 3/4"

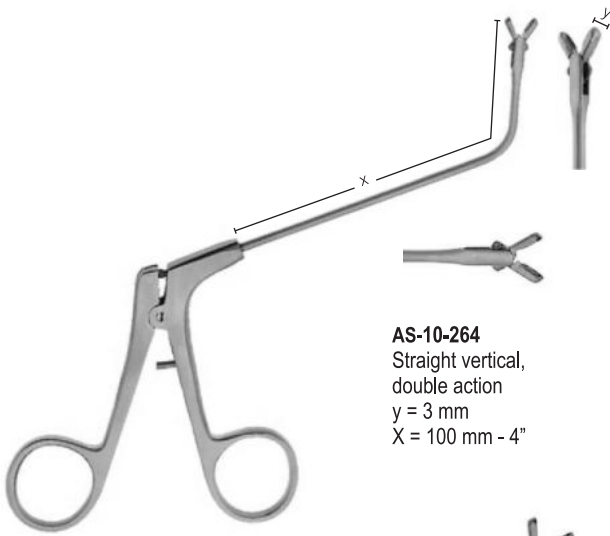

AS-10-264
Straight vertical,
double action
y = 3 mm
X = 100 mm - 4"



AS-10-265
Straight, double action
y = 3 mm
X = 100 mm - 4"



AS-10-266
45° Vertical, double action
y = 3 mm
X = 100 mm - 4"



AS-10-267
45° double action
y = 3 mm
X = 100 mm - 4"

AS-10-264 - AS-10-270



AS-10-268
70° vertical, double
action y = 3 mm
X = 100 mm - 4"



AS-10-269
70° double
action y = 3 mm
X = 100 mm - 4"



AS-10-270
110° double
action y = 3 mm
X = 100 mm - 4"

CIRCULAR FORCEPS AND ANTRUM PUNCH

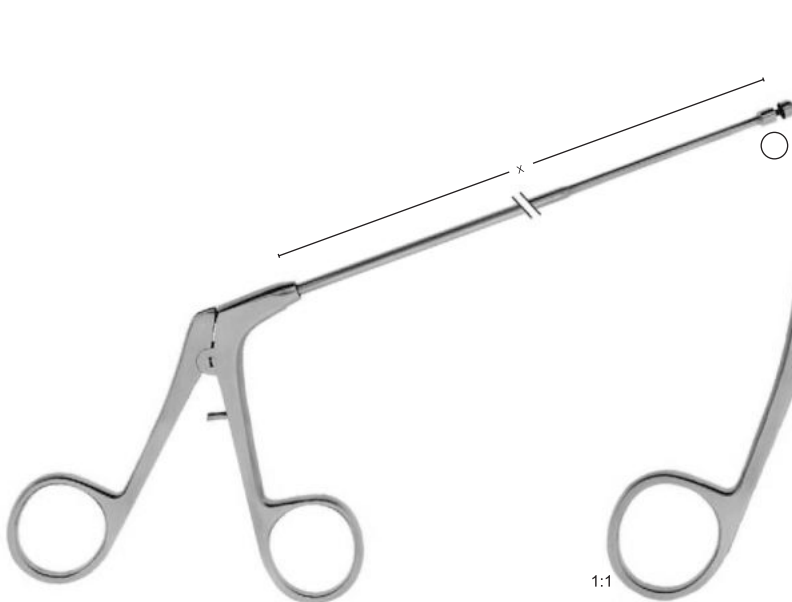

AS-10-271
Straight curved upwards
X = 180 mm - 7"
3.5 mm ø
4.5 mm ø

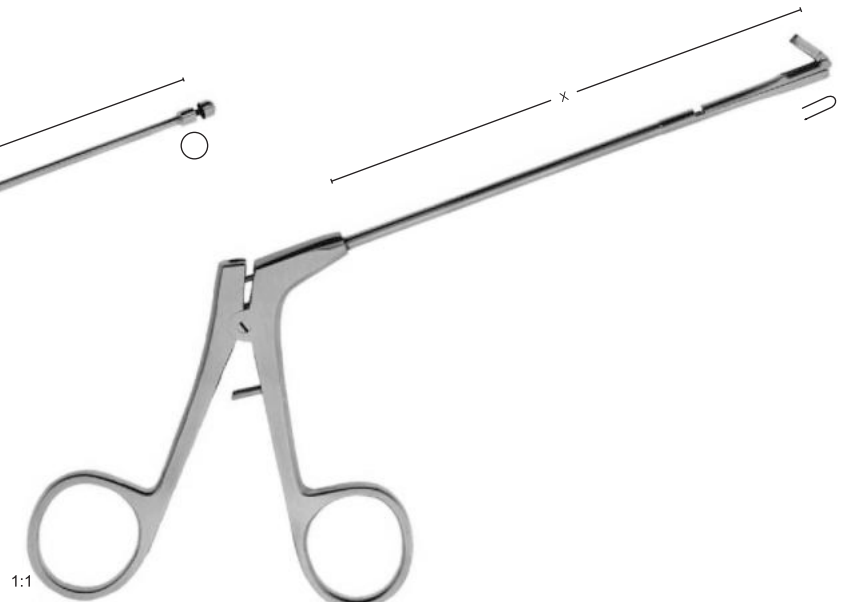

AS-10-272
X = 100 mm
1.5 mm X 4.5 mm
Fig.1 backward, up-cutting
Fig.2 backward, cut to the
right Fig.2 backward, cut to
the left



1:2

FREER
AS-10-273
210 mm - 8 1/4"



1:2

FREER
AS-10-274
210 mm - 8 1/4"



1:2

SICKLE KNIFE
AS-10-275
200 mm - 8"



1:2

BRUNINGS
AS-10-276
230 mm - 9"



1:2

ABRAHAM
AS-10-277
220 mm - 8 3/4"



1:2

FISCHER
AS-10-278
230 mm - 9"



1:2

SHARP
AS-10-279
200 mm - 8"



1:2
LEMPERT
AS-10-280
200 mm - 8"
8" X = 6 mm

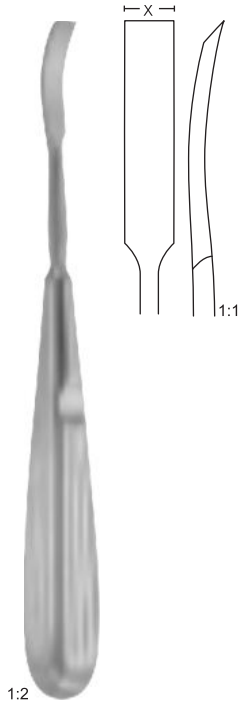

1:2
LEMPERT
AS-10-281
180 mm - 7"



1:2
FREER
AS-10-282
160 mm - 6
1/4" X = 4 mm

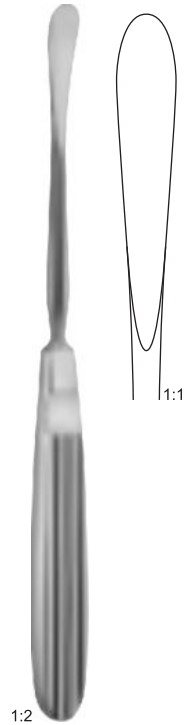

1:2
COTTLE
AS-10-283
sharp
190 mm - 7 1/2"
X = 8 mm

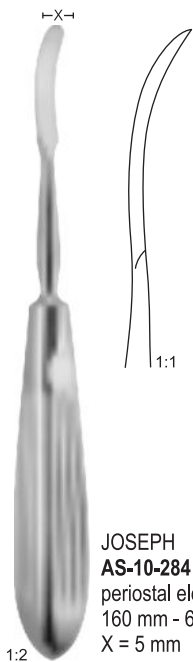

1:2
JOSEPH
AS-10-284
periosteal elevators
160 mm - 6 1/4"
X = 5 mm



1:2
SEWALL
AS-10-285
antrum elevators
200 mm - 8"



1:2
HALLE
AS-10-286
antrum elevators
160 mm - 6 1/4"



MASING
AS-10-287
200 mm - 8"
8"

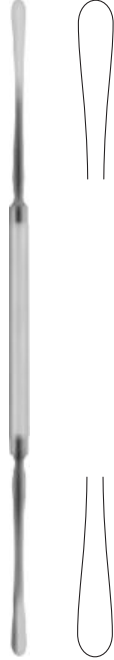

BALLENGER - HAJEK
AS-10-288
190 mm - 7 1/4"
220 mm - 8 3/4"

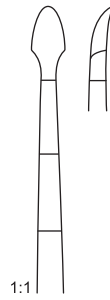

COTTLE
AS-10-289
220 mm - 8 3/4"

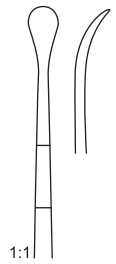

COTTLE
AS-10-290
210 mm - 8 1/4"

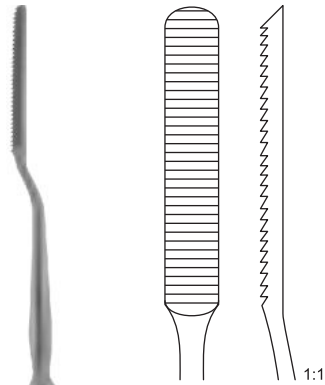

1:2
COTTLE
AS-10-291
 210 mm - 8
 1/4"

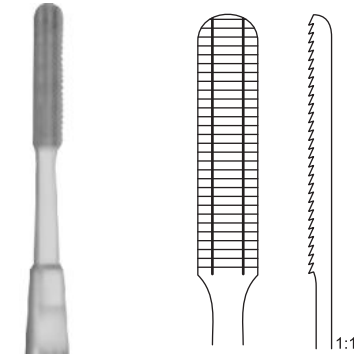

AS-10-292
 Drawing cut
 170 mm - 6 3/4"
 34 mm X 7 mm

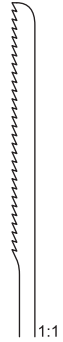

AS-10-293
 Pushing cut
 170 mm - 6 3/4"
 34 mm X 7 mm

1:2
MALTZ
AS-10-292 - AS-10-293

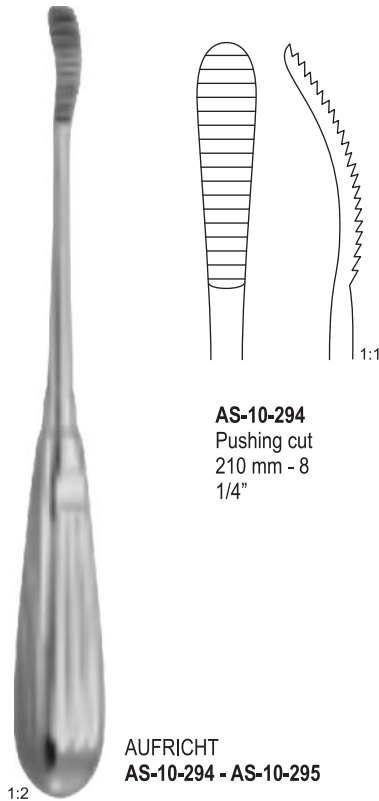

AS-10-294
 Pushing cut
 210 mm - 8
 1/4"

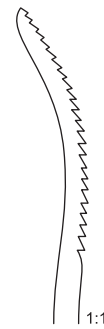

AS-10-295
 Drawing cut
 210 mm - 8
 1/4"

1:2
AUFRICHT
AS-10-294 - AS-10-295

RASPS WITHOUT TUNGSTEN CARBIDE



1:1

AS-10-296 - 205
200 mm - 8"



FOMON
Teeth

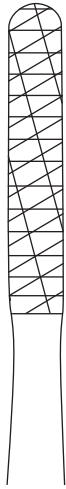

1:1

AS-10-296
Fig.1 12

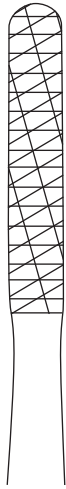

1:1

AS-10-297
Fig.3 16



1:1

AS-10-298
Fig.5 24



1:1

AS-10-299
Fig.7 36

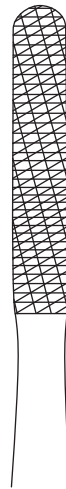

1:1

AS-10-300
Fig.9 52



FOMON TC
Teeth



AS-10-301
Fig.2 14

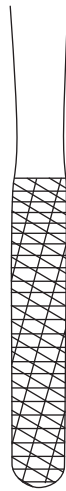

AS-10-302
Fig.4 20

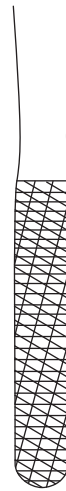

AS-10-303
Fig.6 30

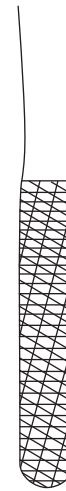

AS-10-304
Fig.8 44

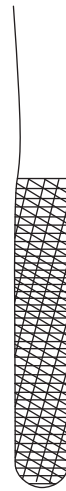

AS-10-305
Fig.10 62



AS-10-306 - AS-10-308

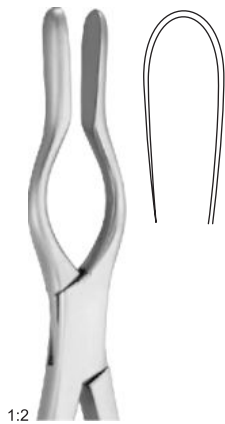

1:2

AS-10-306
Straight



1:2

AS-10-307
Left

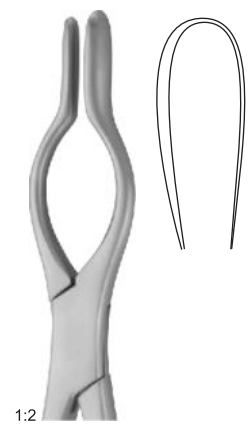

1:2

AS-10-308
Right



1:2

ASCH AS-
10-309 230
mm - 9"

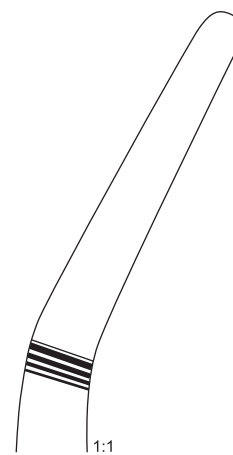

1:1

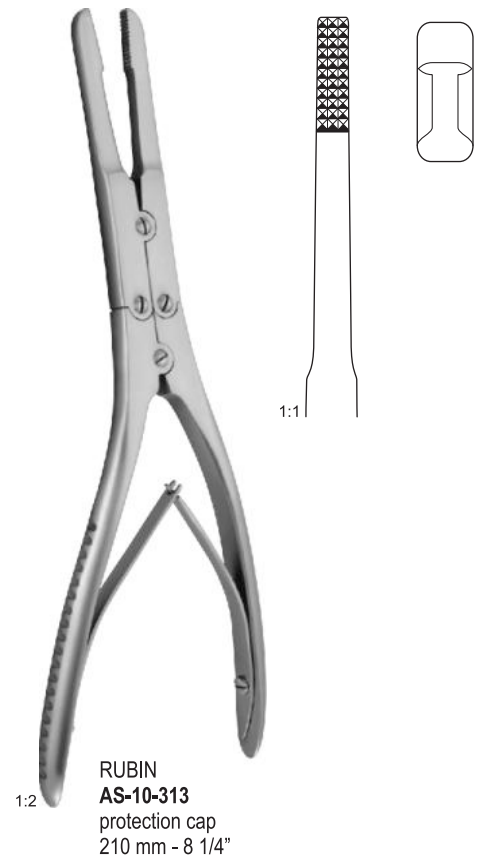
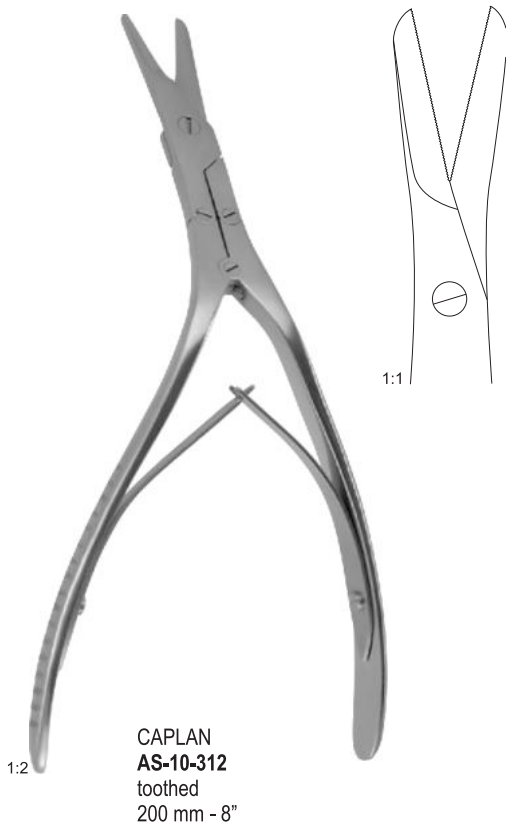
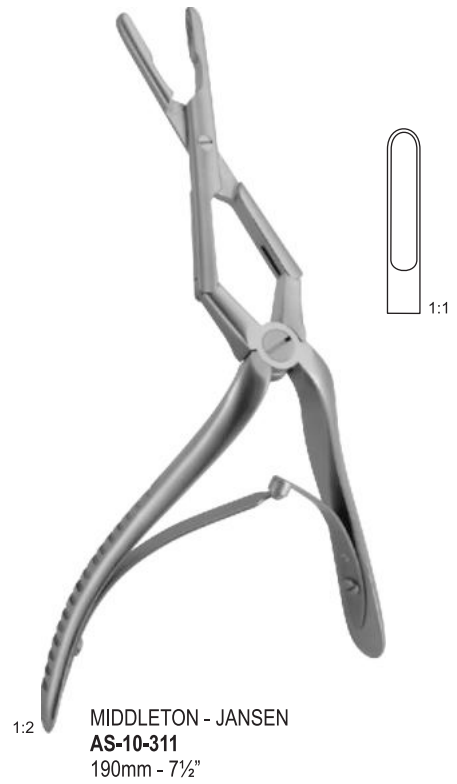

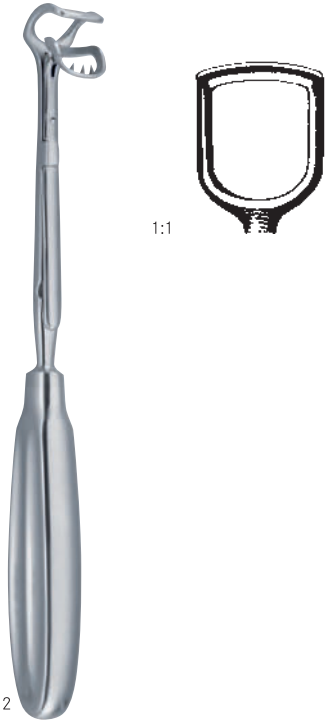

1:2
ST. CLAIR-THOMSON
AS-10-314
 210 mm - 8 1/4"

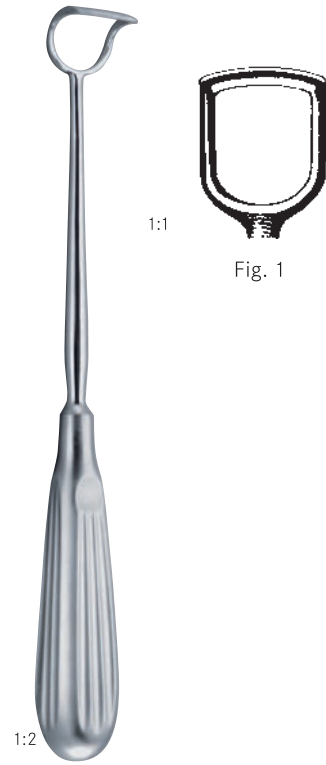

1:2
BARNHILL
AS-10-315
 220 mm - 8 3/4"



BECKMANN
AS-10-316
 Straight Curved
 220 mm - 8 3/4"

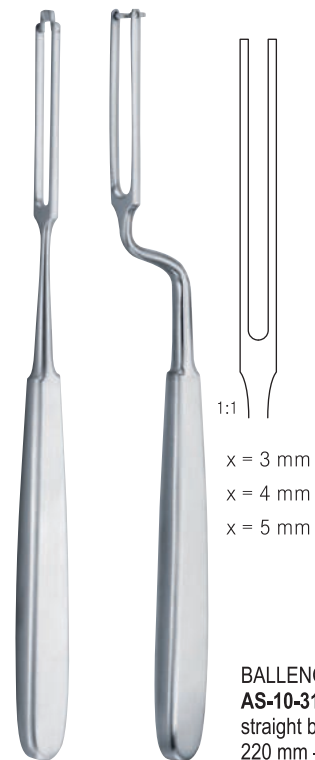

1:1
 x = 3 mm
 x = 4 mm
 x = 5 mm
BALLENGER
AS-10-317
 straight bayonet
 220 mm - 8"



1:2

MOLT
AS-10-318
for children
110 mm - 4 1/4"



1:2

MOLT
AS-10-319
for adults
140 mm - 5 1/2"



1:2

DENHART
AS-10-320
120 mm - 4 3/4"



1:2

FERGUSON - ACKLAND
AS-10-321
145 mm - 5 3/4"



ROSER - KÖNIG
AS-10-322
160 mm - 6 1/4"
190 mm - 7 1/2"



AS-10-33	Fig.00	8 mm	∅
AS-10-324	Fig.0	10 mm	∅
AS-10-325	Fig.1	12 mm	∅
AS-10-326	Fig.2	14 mm	∅
AS-10-327	Fig.3	16 mm	∅
AS-10-328	Fig.4	18 mm	∅
AS-10-329	Fig.5	20 mm	∅
AS-10-330	Fig.6	22 mm	∅
AS-10-331	Fig.7	24 mm	∅
AS-10-332	Fig.8	26 mm	∅
AS-10-333	Fig.9	28 mm	∅
AS-10-333	Fig.10	30 mm	∅

AS-10-323 - AS-10-333



1:2
AS-10-334
100 mm - 4"



AS-10-335	Fig.00	8 mm	∅
AS-10-336	Fig.0	10 mm	∅
AS-10-337	Fig.1	12 mm	∅
AS-10-338	Fig.2	14 mm	∅
AS-10-339	Fig.3	16 mm	∅
AS-10-340	Fig.4	18 mm	∅
AS-10-341	Fig.5	20 mm	∅
AS-10-342	Fig.6	22 mm	∅
AS-10-343	Fig.7	24 mm	∅
AS-10-344	Fig.8	26 mm	∅
AS-10-345	Fig.9	28 mm	∅
AS-10-346	Fig.10	30 mm	∅

AS-10-335 - AS-10-346



AS-10-347	10 mm	∅
AS-10-348	12 mm	∅
AS-10-349	14 mm	∅
AS-10-350	16 mm	∅
AS-10-351	18 mm	∅

MICHEL
AS-10-347 - AS-10-351
moveable mirror
250 mm - 9 3/4"



1:2
EVES
AS-10-352
280 mm - 11"



1:2
EVES
AS-10-353
280 mm - 11"



1:2
BRUENINGS
AS-10-354
280 mm - 11"



AS-10-355
10 mm - 3/8"
0.3 mm Ø
0.4 mm Ø

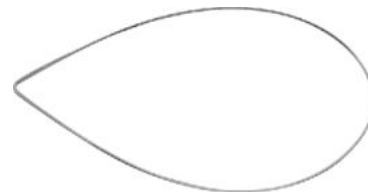

AS-10-356
Package of 100 pieces
40 mm
50 mm



COLVER
AS-10-357
straight
curved 190
mm - 7½"



WHITE
AS-10-358
180 mm - 7"
230 mm - 9"

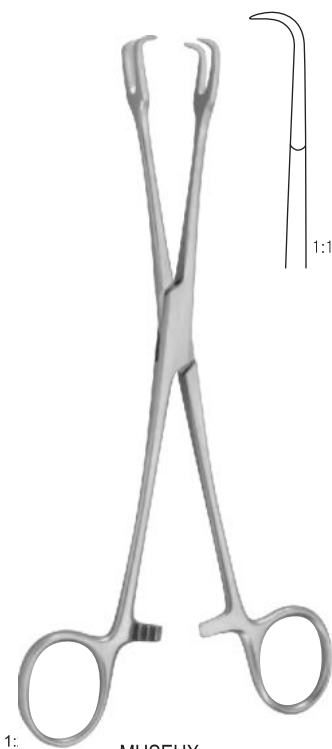

MUSEUX
AS-10-359
tonsil holding
forceps 200 mm - 8"



JACKSON
AS-10-360
laryngeal forceps
220 mm - 8½"

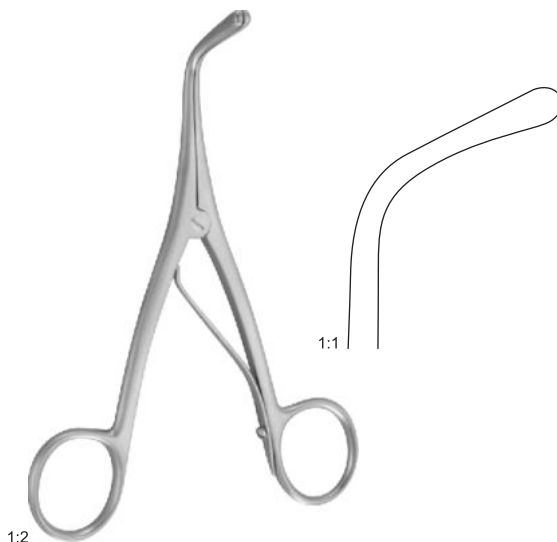

TROUSSEAU
AS-10-361
140 mm - 5½"

TRACHEA DILATOR

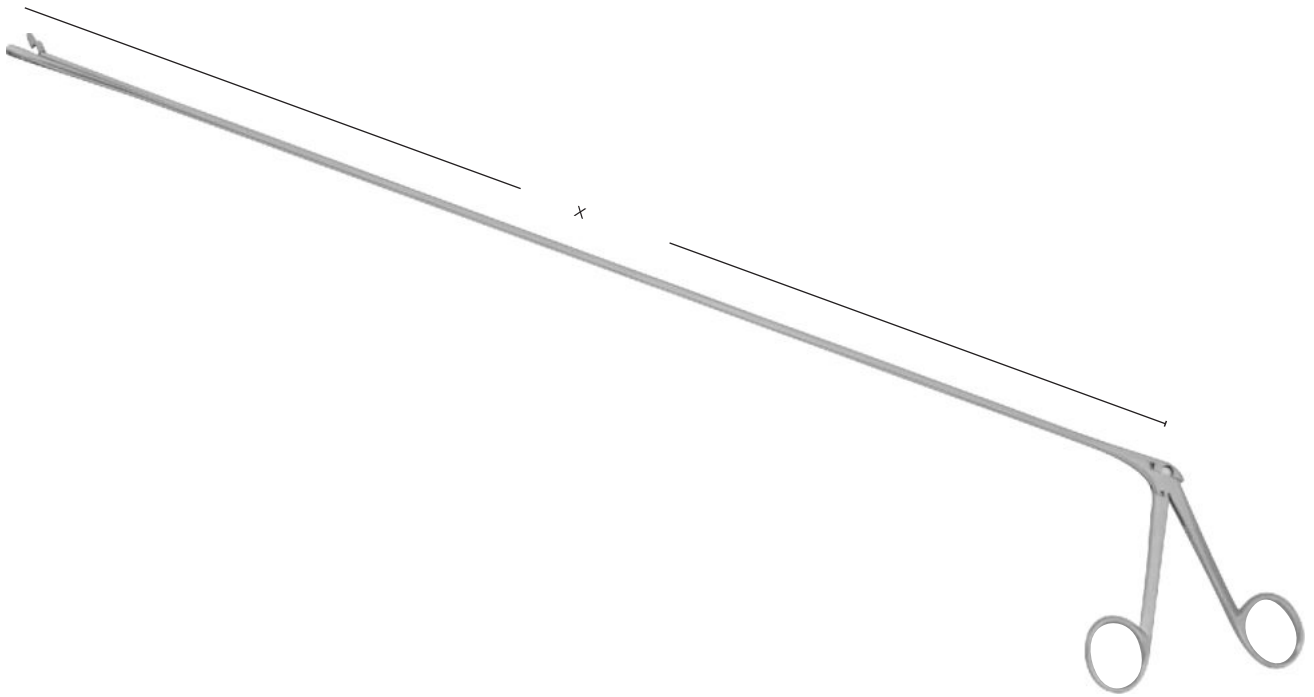

CHEVALIER - JACKSON
AS-10-32 - AS-10-368
X = 300 mm - 12"
X = 400 mm - 16"
X = 500 mm - 20"
X = 600 mm - 23½"



AS-10-362



AS-10-363



AS-10-364



AS-10-365



AS-10-366



AS-10-367



AS-10-368

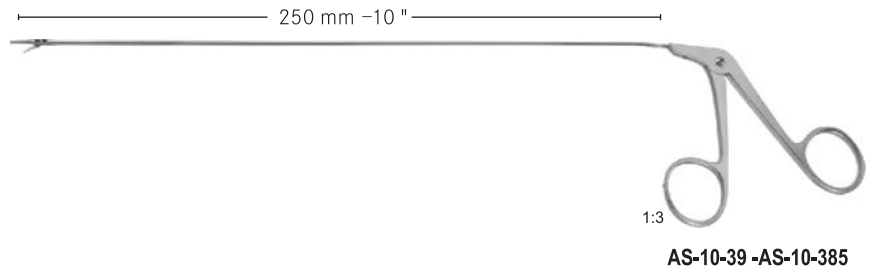

AS-10-39 -AS-10-385

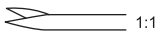

AS-10-369
Straight



AS-10-370
Straight horizontal



AS-10-371
Angled up horizontal

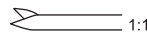

AS-10-372
Curved right

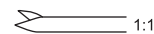

AS-10-373
Curved left



AS-10-374
Angled up



AS-10-375
Straight, serrated



AS-10-376
Straight horizontal



AS-10-377
Angled up horizontal



AS-10-378
Curved right



AS-10-379
Curved left

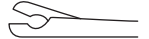

AS-10-380
Straight



AS-10-381
Angled up
02,5 mm

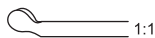

AS-10-382
Angled up horizontal



AS-10-383
Curved right



AS-10-384
Curved left

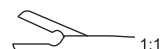

AS-10-385
Oval
03,5 mm



1/2

DAVIS-BOYLE
AS-10-386 - AS-10-388
 complete, consisting of frame
 and 5 tongue depressors no. 1-
 5

AS-10-386
 Frame for Mouth Gag

AS-10-387
 14.5 cm
 Frame for Mouth Gag with
 joint
AS-10-388
 14.5 cm
 Silicone
 inlay



1/2

Fig. 1
AS-10-389 - AS-10-392
 110 X 28 mm



Fig. 2
AS-10-389 95 X 27 mm



Fig. 3
AS-10-390 80 X 27 mm



Fig. 4
AS-10-391 65 X 26 mm



Fig. 5 **AS-10-392**
 without suction
 tube 30 X 20 mm



NEUKAM
AS-10-393 - 297
complete, with frame
and 3 tongue depressors

NEUKAM
AS-10-393
Frame for Mouth Gag,
only



AS-10-394
Tongue Depressor

fenestrated blade for
suction

Fig. 1
AS-10-395

Fig. 2
AS-10-396

Fig. 3
AS-10-397



KILNER-DOUGHTY
AS-10-38 - AS-10-304
complete, with frame, 3 tongue depressors,
2 toothplates and 1 palate plate



AS-10-399
Palate plate

KILNER-DOUGHTY
AS-10-400
14.5 cm
Frame for Mouth Gag

KILNER-DOUGHTY
AS-10-401
Tongue Depressor

fenestrated blade for suction 1/2



Fig. 1 **AS-10-402**
68 X 30 mm

Fig. 2 **AS-10-403**
77 X 34 mm

Fig. 3 **AS-10-404**
82 X 39 mm

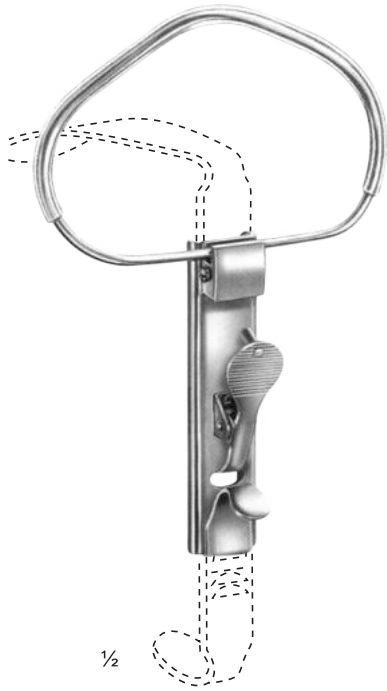

MCLVOR
AS-10-405 - 309
complete, with 3 tongue depressors

MCLVOR AS-10-405
Frame for Mouth
Gag

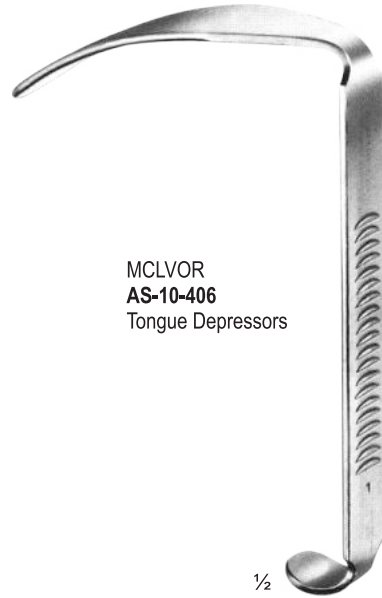

MCLVOR
AS-10-406
Tongue Depressors

Fig. 1 AS-10-407
100 X 25 mm

Fig. 2 AS-10-408
85 X 25 mm

Fig. 3 AS-10-409
75 X 25 mm

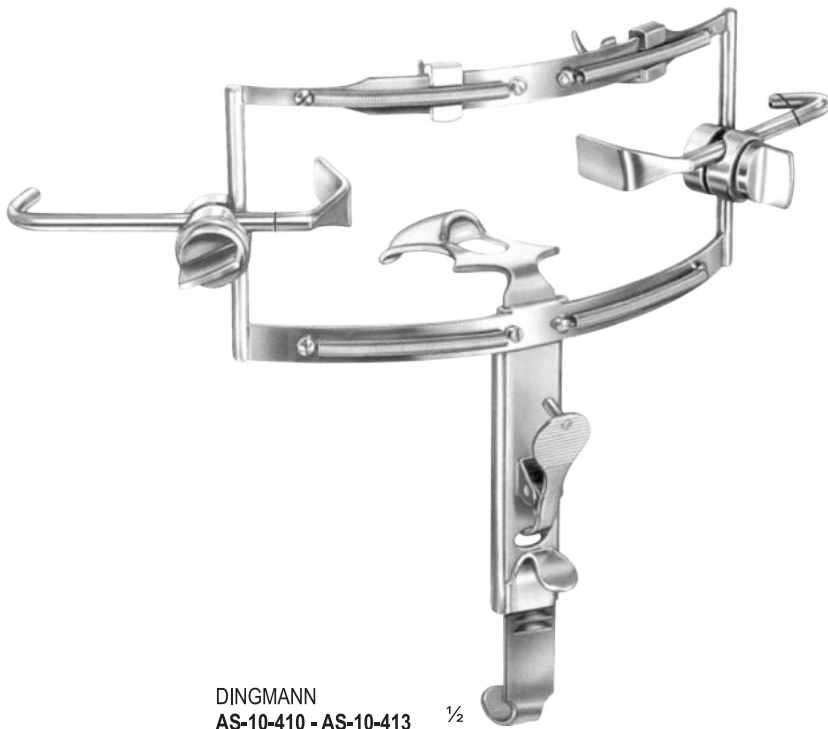

DINGMANN
AS-10-410 - AS-10-413 1/2
complete, with frame, 3 tongue depressors,
and 2 adjustable lateral blades

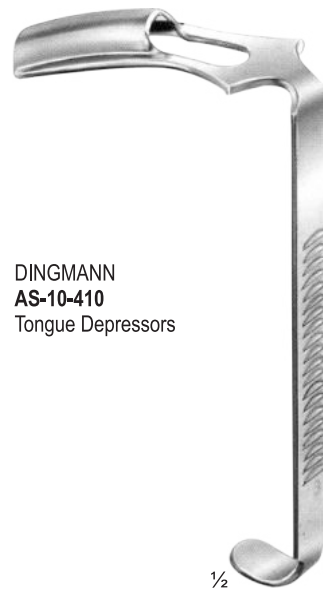

DINGMANN
AS-10-410
Tongue Depressors

Fig. 1
AS-10-4 11 62 X
26 mm

Fig. 2
AS-10-412 65 X
30 mm

Fig. 3
AS-10-413 78 X
32 mm



AS-10-414 Fig.1
20 mm X 70 mm



AS-10-415 Fig.2
30 mm X 80 mm



AS-10-416 Fig.3
33 mm X 95 mm



AS-10-417
Handle

NEGUS
AS-10-414 - AS-10-417
complete handle

TONSIL INSTRUMENTS

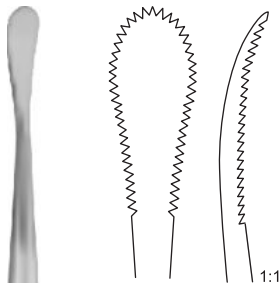

1:1

1:2

HENKE
AS-10-418
tonsil dissector
230 mm - 9"

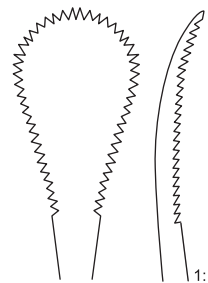

1:1

1:2

HENKE
AS-10-419
tonsil dissector
230 mm - 9"

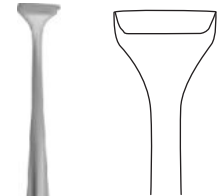

1:2

HURD
AS-10-420
tonsil dissector
225 mm - 8 3/4"



JENNINGS
AS-10-421 - AS-10-424
AS-10-421 10.5 cm
AS-10-422 12.5 cm
AS-10-423 14.5 cm
AS-10-424 16.5 cm

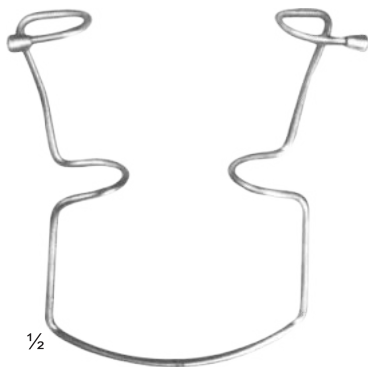

ORINGER
AS-10-425 - AS-10-427
 9.5 cm
 self retaining, for children

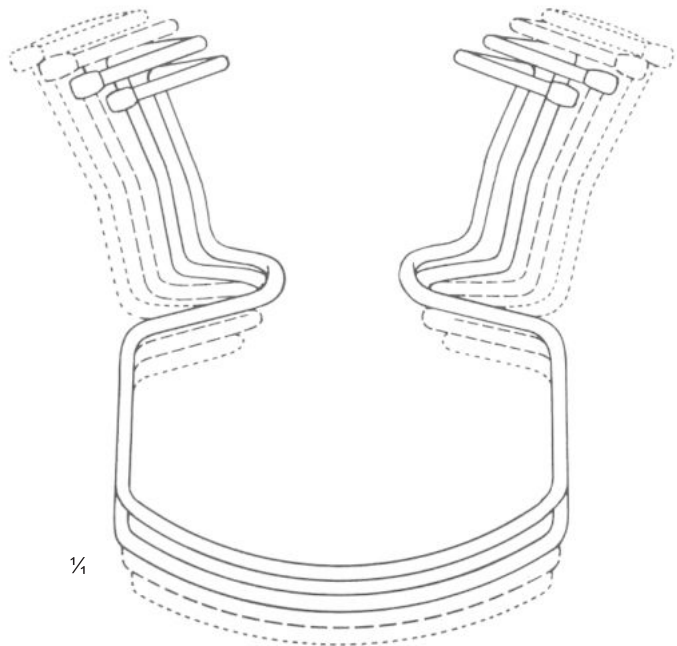
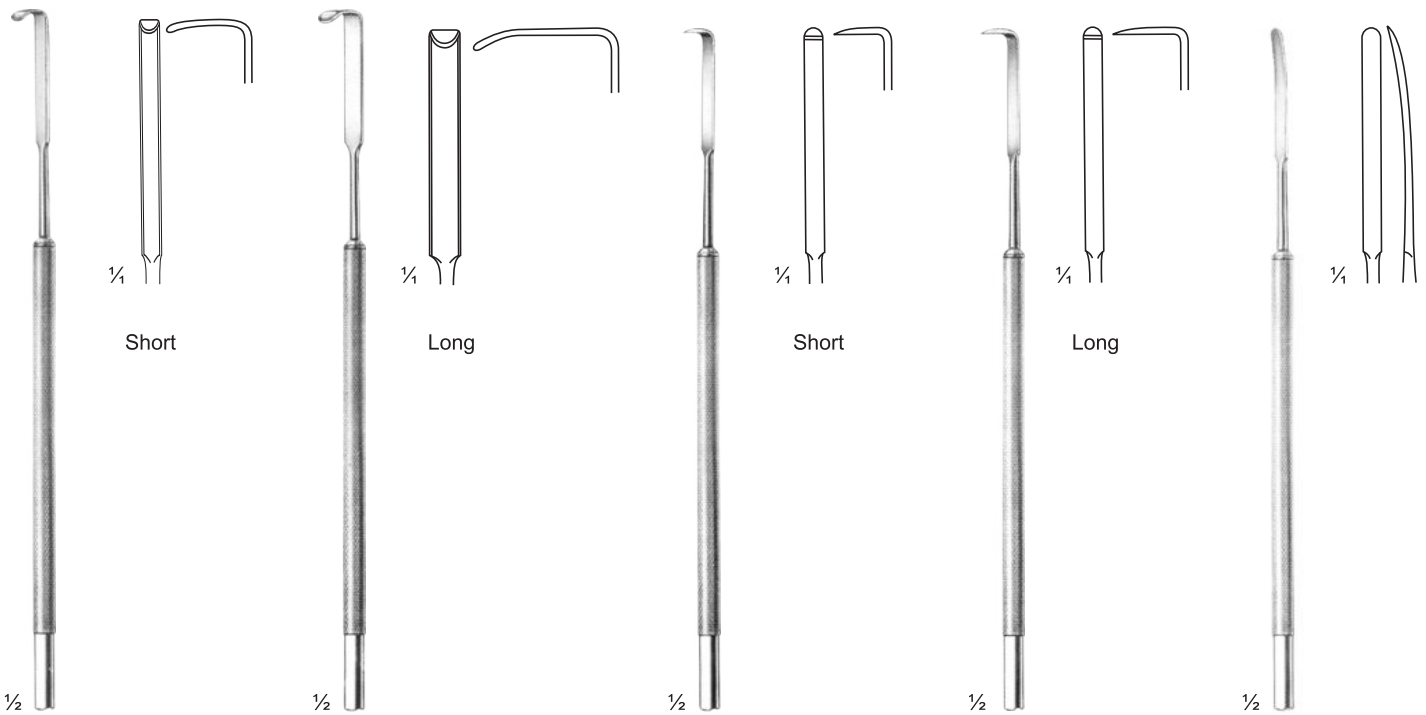

Fig. 1
AS-10-425
 10 cm

Fig. 2
AS-10-426
 10.5 cm

Fig. 3
AS-10-427
 11 cm



SALYER
AS-10-428
185 mm
Cleft Palate
Hooklets

SALYER
AS-10-429
185 mm
Cleft Palate
Hooklet

SALYER
AS-10-430
180 mm
Cleft Palate
Dissector

SALYER
AS-10-431
180 mm
Cleft Palate
Dissector

SALYER
AS-10-432
180 mm
Cleft Palate
Instruments

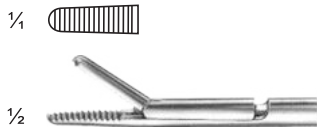

FRAENKEL **AS-10-433**
for interchangeable tubes

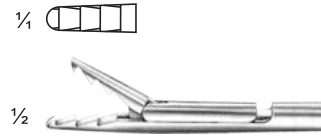

SEIFFERT **AS-10-434**
for interchangeable tubes

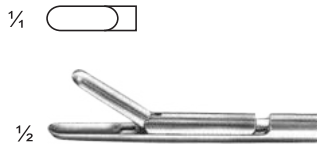

FRAENKEL **AS-10-435**
for interchangeable tubes

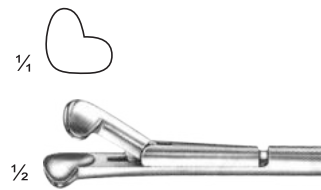

SCHEINMANN **AS-10-436**
for interchangeable tubes

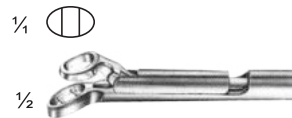

SCHEINMANN **AS-10-437**
for interchangeable tubes



BRÜNINGS
AS-10-438 - AS-10-439
for interchangeable
tubes

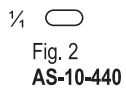
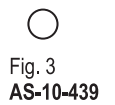
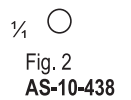

BRÜNINGS
AS-10-440 - AS-10-441
for interchangeable tubes



LANGE **AS-10-442**
for interchangeable tubes

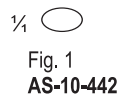



Fig. 1
AS-10-443



Fig. 2
AS-10-444



KRAUSE
AS-10-443 - AS-10-444
for interchangeable tubes



¼



KRAUSE AS-10-445
for interchangeable tubes



Fig. 1
AS-10-446



Fig. 2
AS-10-447



Fig. 3
AS-10-448



Fig. 4
AS-10-449

¼



CORDES
AS-10-446 - AS-10-449
for interchangeable tubes



¼



SCHUMACHER
AS-10-450
for interchangeable tubes



Fig. 1
AS-10-451



Fig. 2
AS-10-452

¼



CORDES
AS-10-451 - AS-10-452
for interchangeable tubes



¼



CORDES AS-10-453
for interchangeable tubes

¼



ROSENBERG
AS-10-454
for interchangeable tubes



ASAMAR
SURGICAL 

PAGE

223-241

ELEVATORS
BONE LEVERS
RASPATORIES
BONE FILES
BONE CURETTES

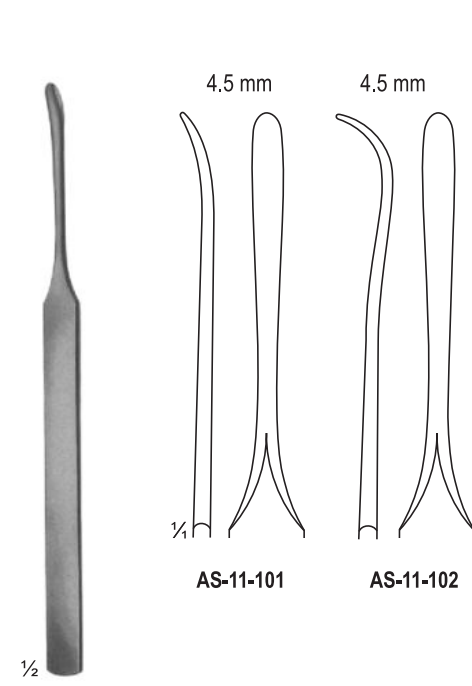

AS-11-101 - AS-11-102
KONIG
155 mm

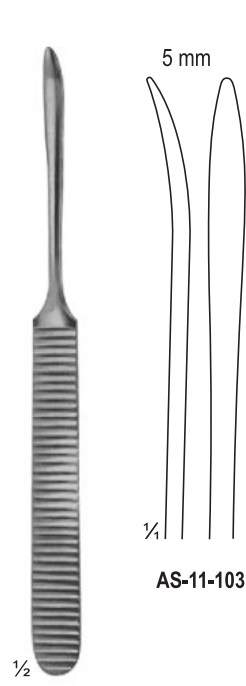

RS-003
WILLIGER
165 mm

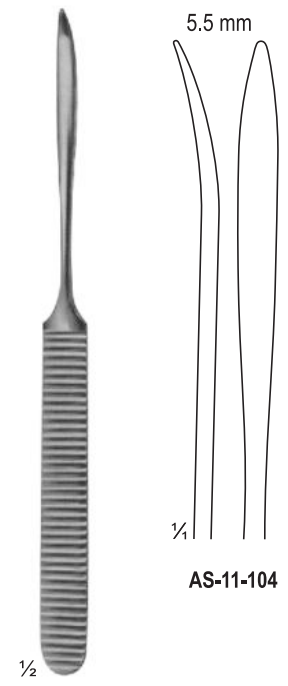

AS-11-104
WILLIGER
170 mm

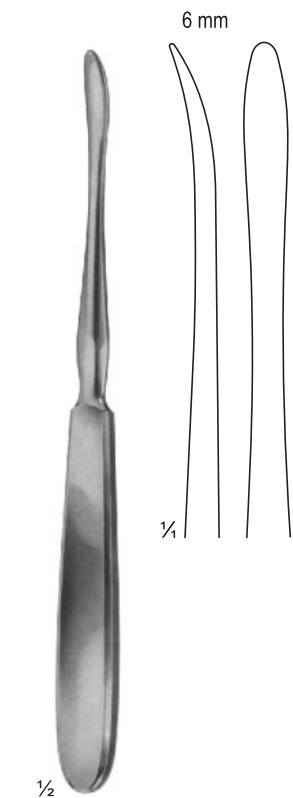

AS-11-105
QUERVAIN
195 mm

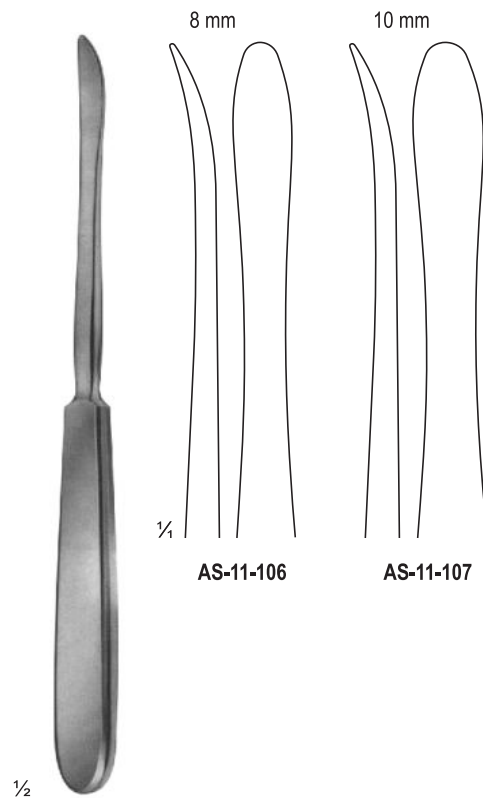

AS-11-106 - AS-11-107
LANGENBECK
195 mm

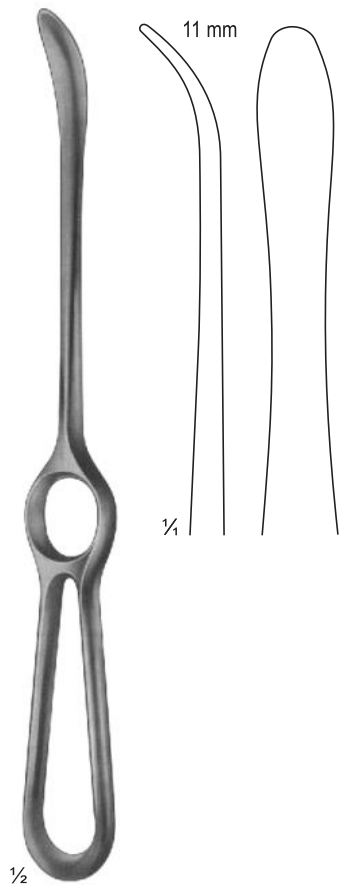

AS-11-108
LANGENBECK
230mm

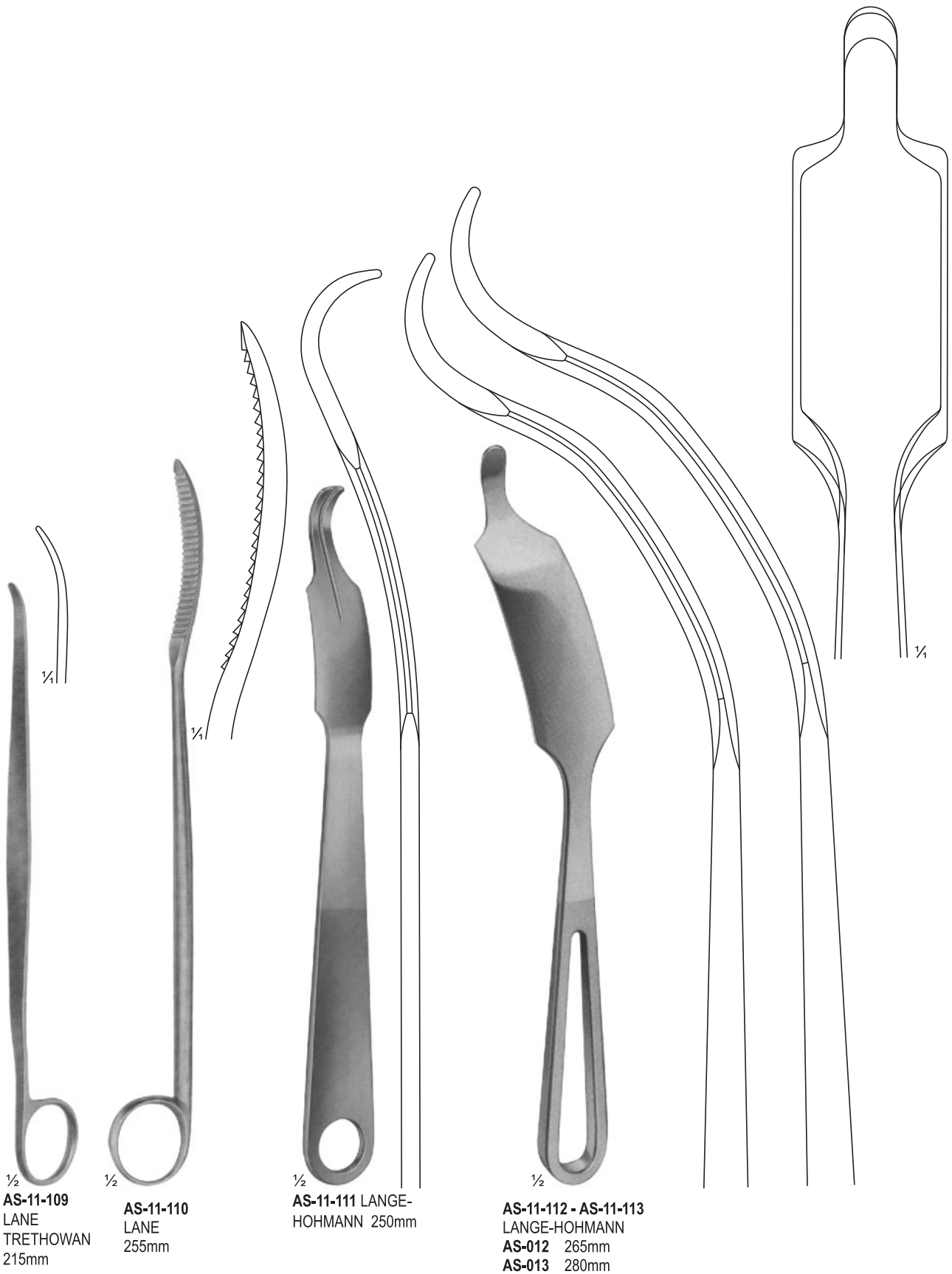

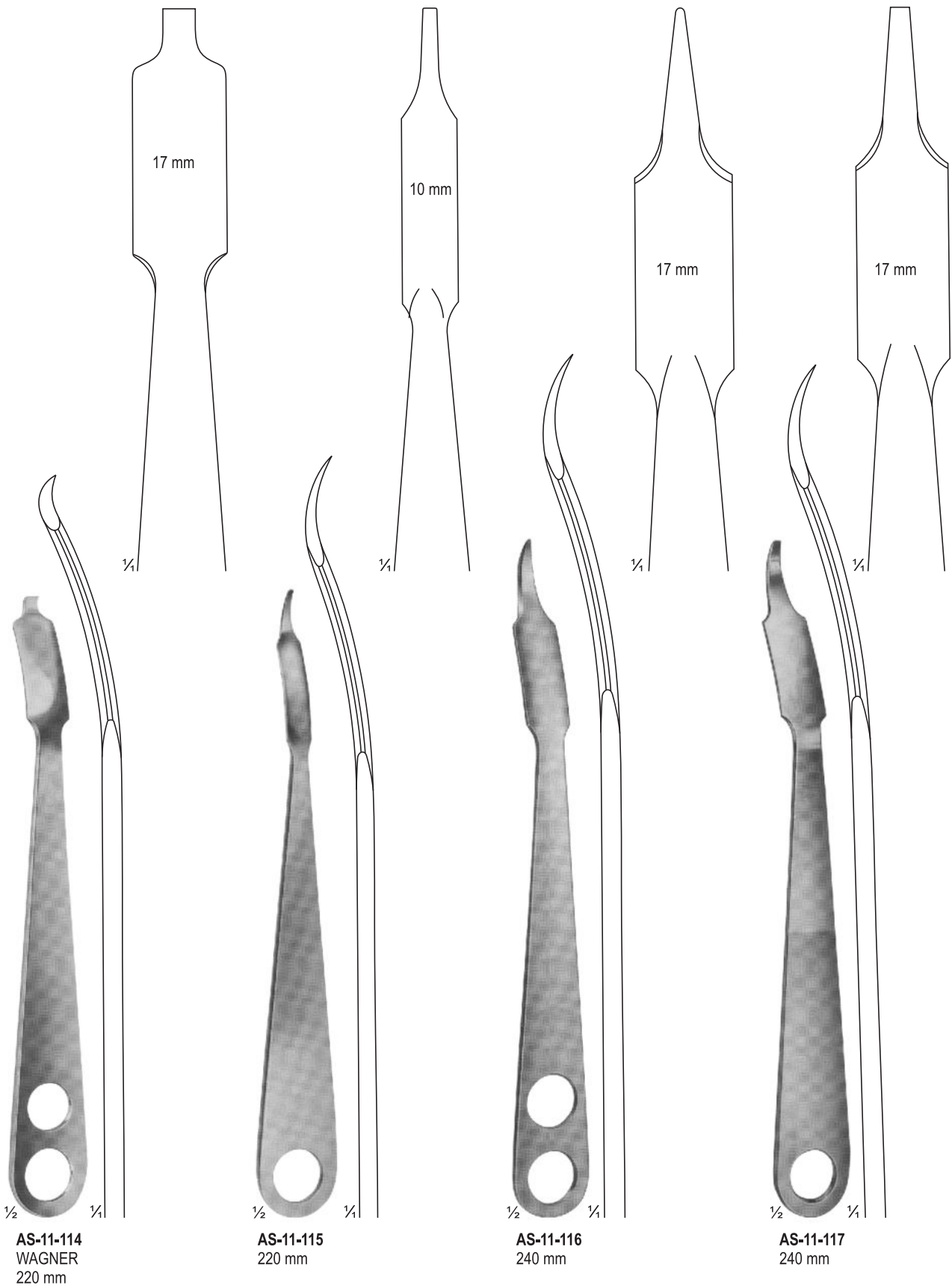

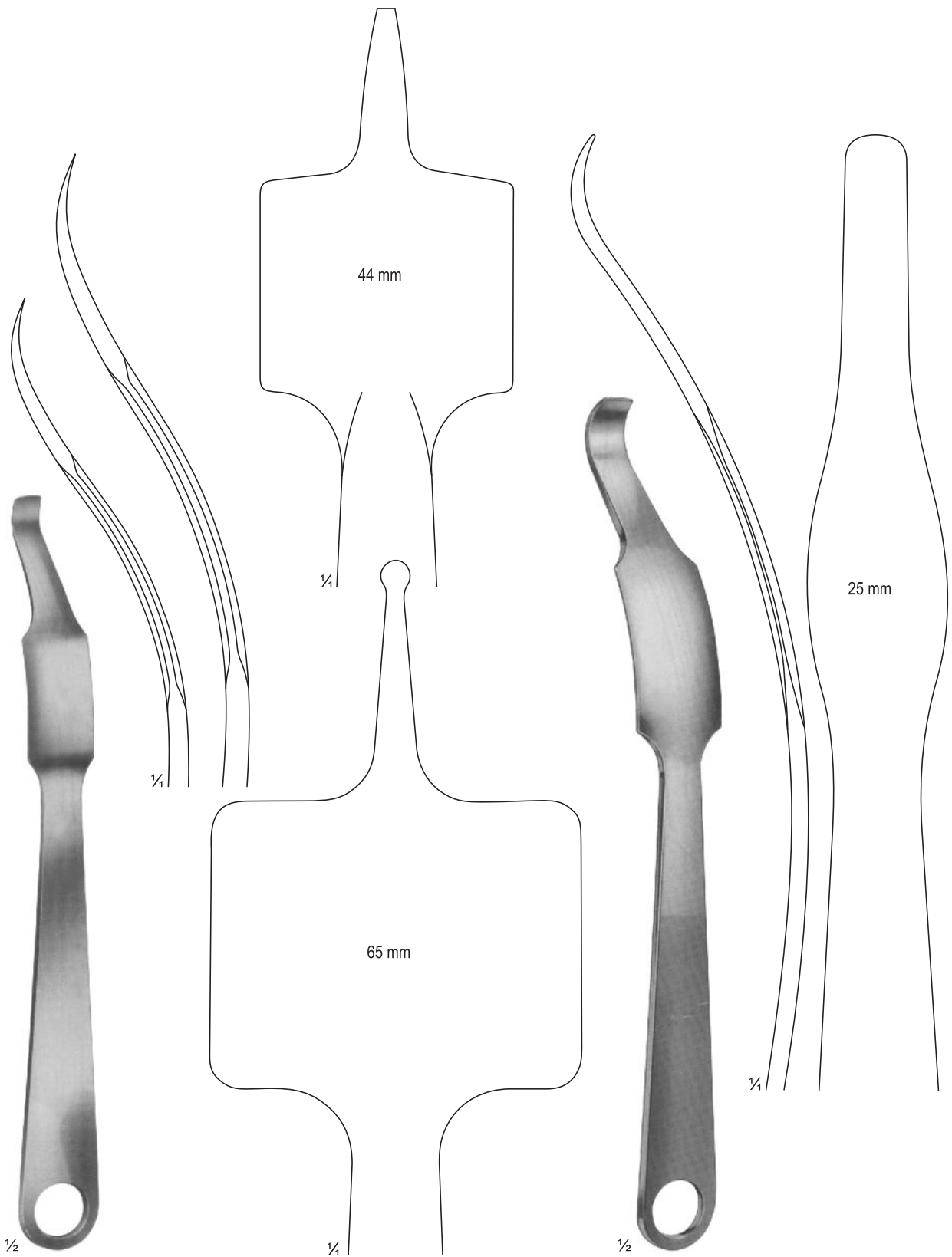

AS-11-118 - AS-11-119
VERBRUGGE-MULLER
AS-11-118 240 mm
AS-11-119 255 mm

AS-11-120
260 mm

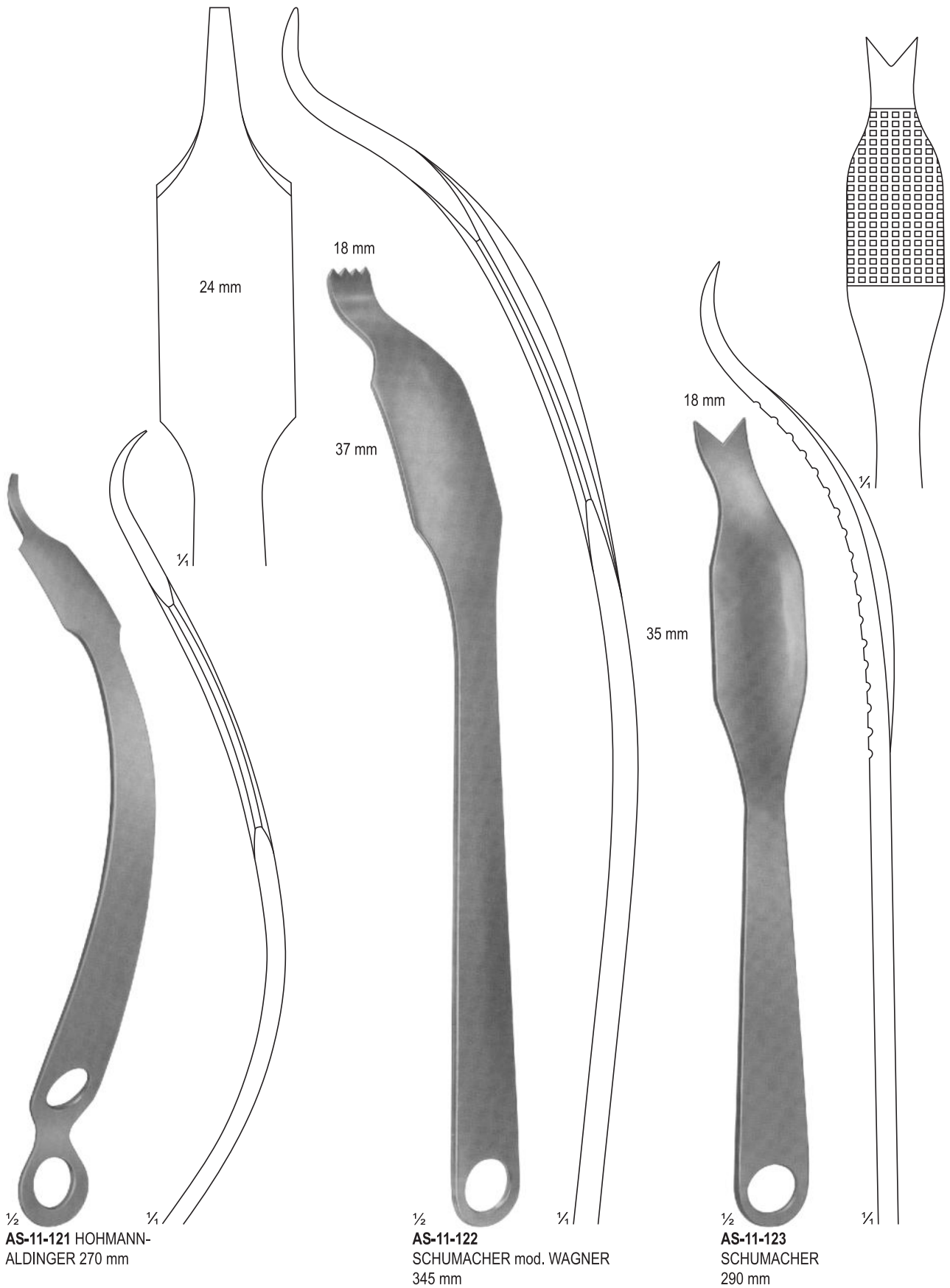

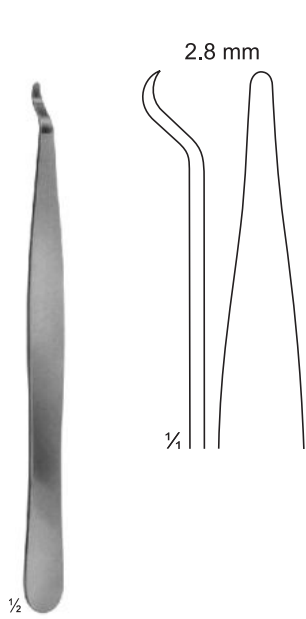

AS-11-124
140 mm

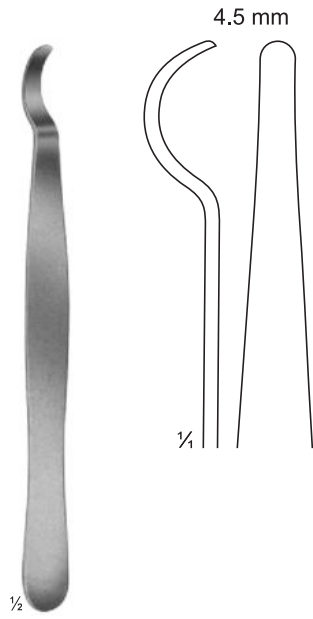

AS-11-125
150 mm

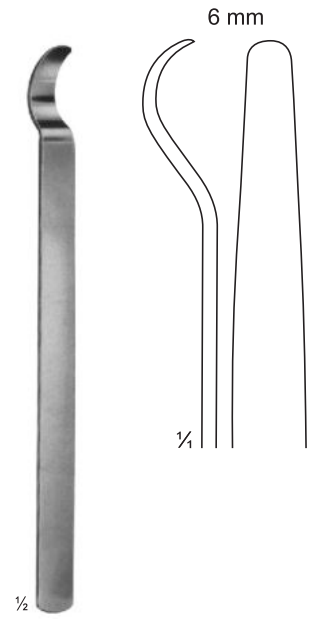

AS-11-126
150 mm

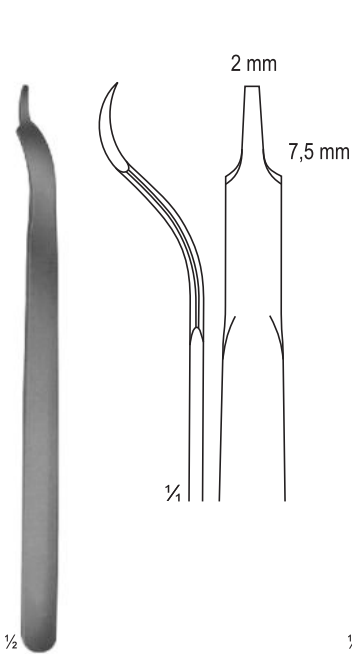

BUCK-GRAMCKO AS-11-127
150 mm

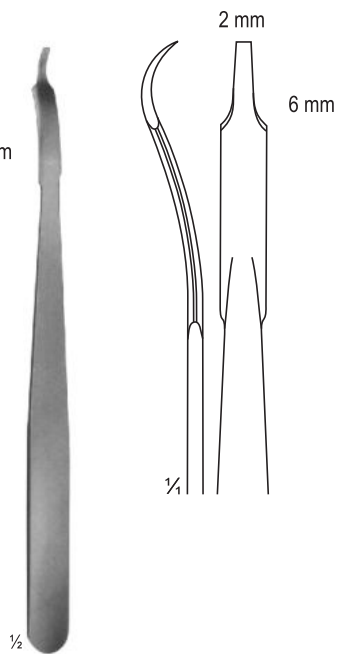

AS-11-128
160 mm

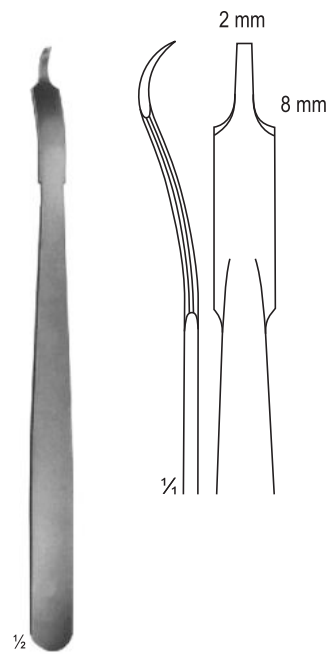

AS-11-129
160 mm

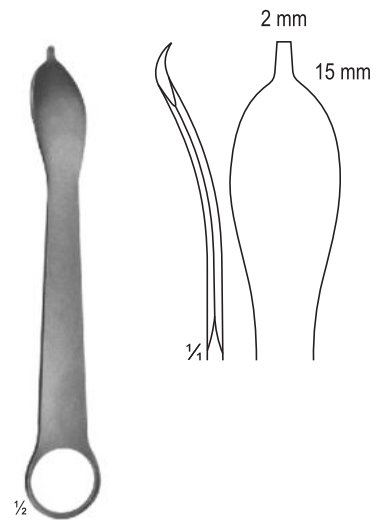

AS-11-130
125 mm

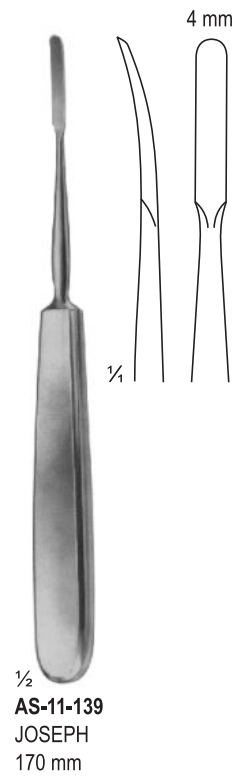
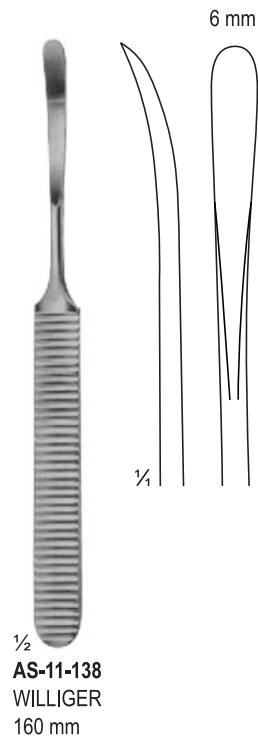
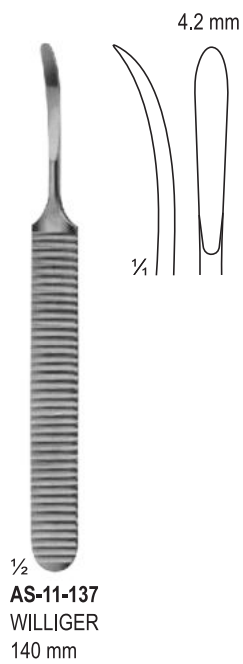
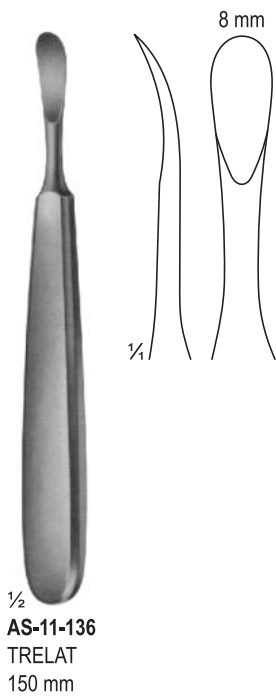
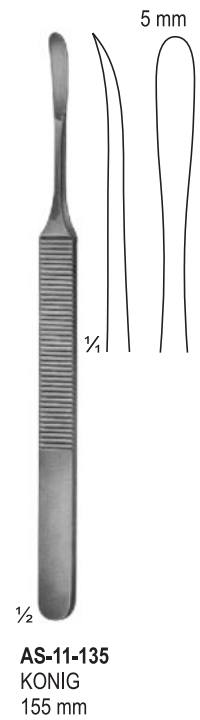
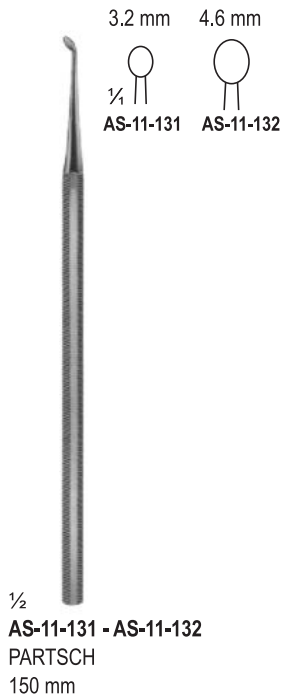

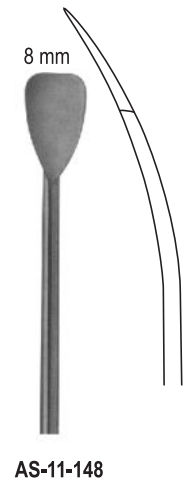
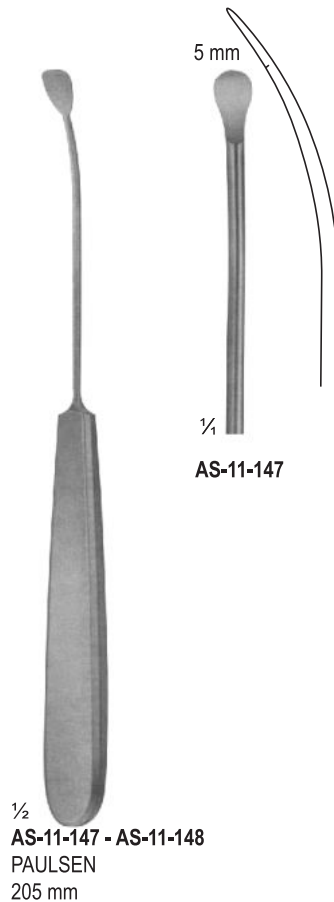
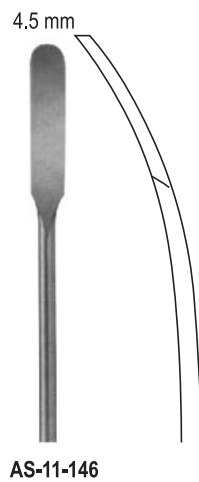
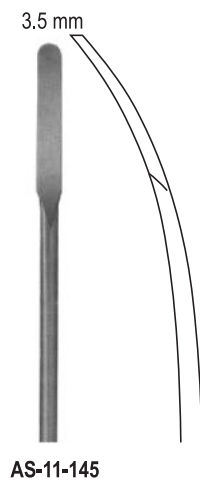
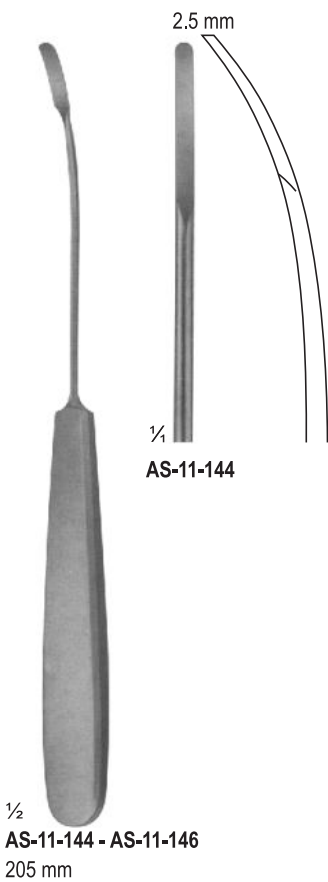
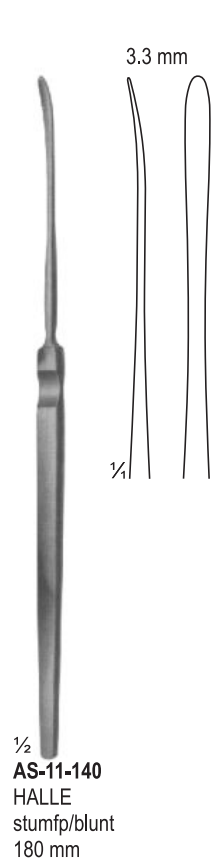

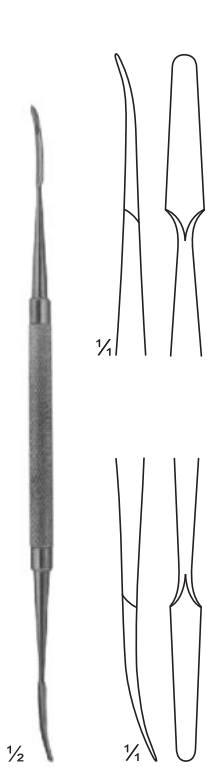

1/2
AS-11-149
KILLIAN
sharp/blun
t 185 mm

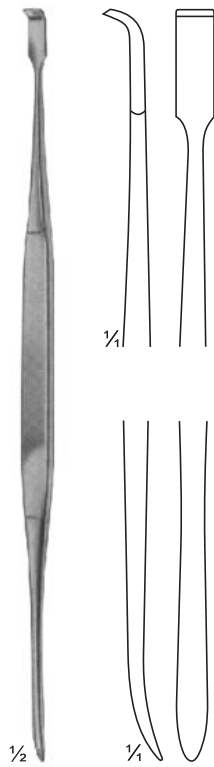

1/2
AS-11-150
HOWARTH
sharp/blunt
215 mm

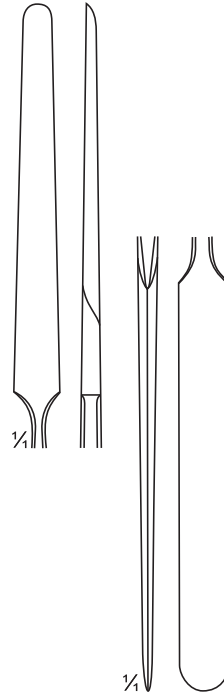

1/2
AS-11-151
KILLIAN
sharp/blun
t 185 mm

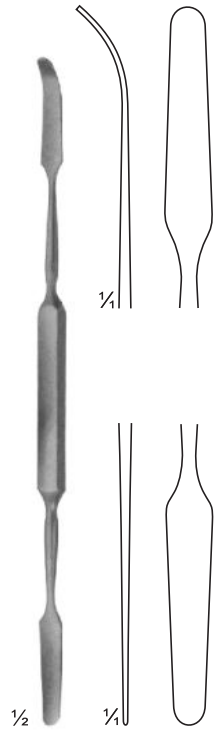

1/2
AS-11-152
MAC DONALD
blunt/blunt
185 mm

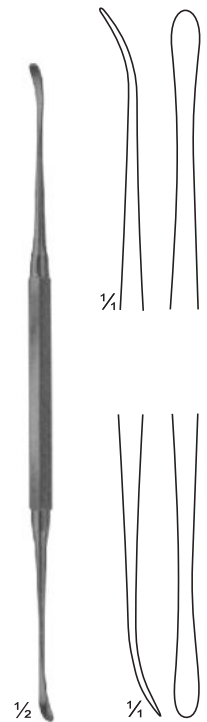

1/2
AS-11-153
FREER
sharp/blun
t 185 mm

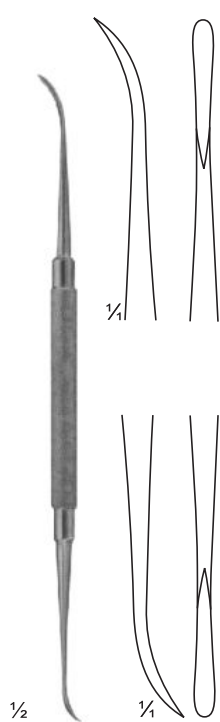

1/2
AS-11-154
FREER-YASARGIL
sharp/sharp
185 mm

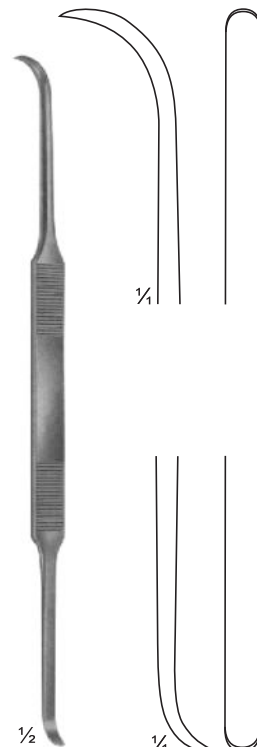

1/2
AS-11-155
COTTLE
sharp/shar
p 200 mm

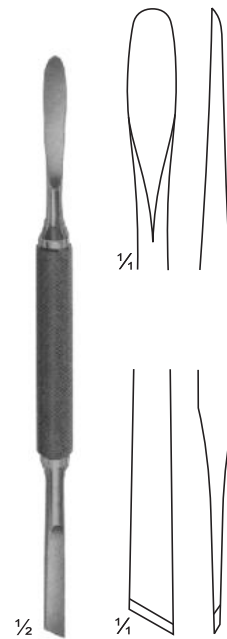

1/2
AS-11-156
MEAD
sharp/shar
p 165 mm

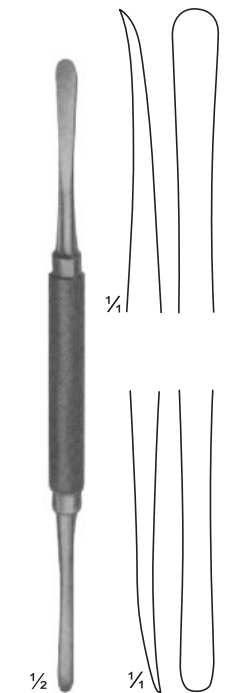

1/2
AS-11-157
MOLT
sharp/shar
p 180 mm



AS-11-158 - AS-11-171
MANNERFET
155 mm



AS-11-158
4 mm



AS-11-159
7 mm

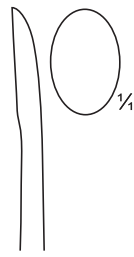
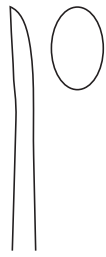

AS-11-160
9 mm



AS-11-163
6 mm



AS-11-164
6 mm

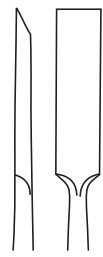

AS-11-165
8 mm



AS-11-161
3 mm

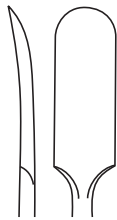

AS-11-162
6 mm

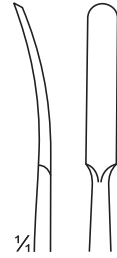

AS-11-166
4 mm



AS-11-167
5 mm



AS-11-168
6 mm



AS-11-169
4 mm 90°



AS-11-170
6 mm
90°



AS-11-171
3,5 mm
45°

6 mm

8 mm



AS-11-172 - AS-11-173
165 mm

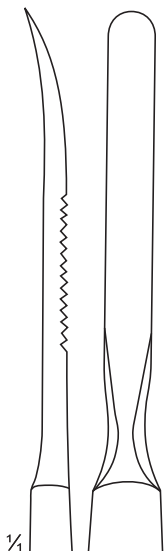

AS-11-172

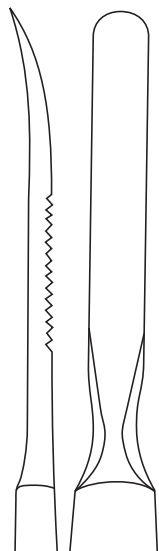

AS-11-173



AS-11-174 - AS-11-177
ADSON
170 mm

8 mm

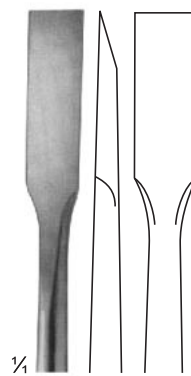

AS-11-174

7 mm

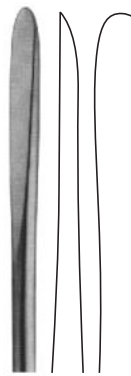

AS-11-175

7 mm

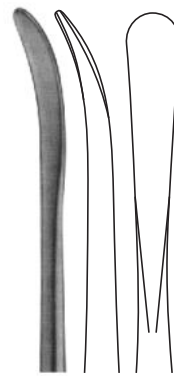

AS-11-176

7 mm

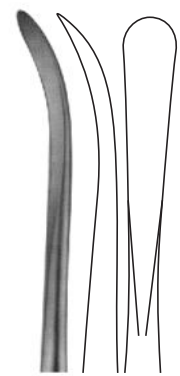

AS-11-177

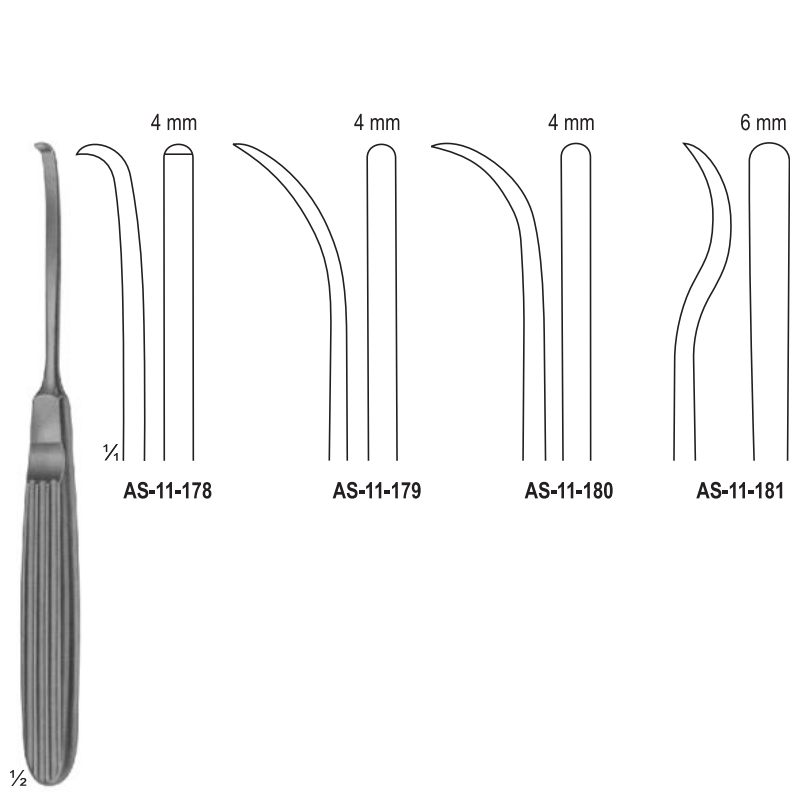

AS-11-178 - AS-11-181
MUHLING
170 mm

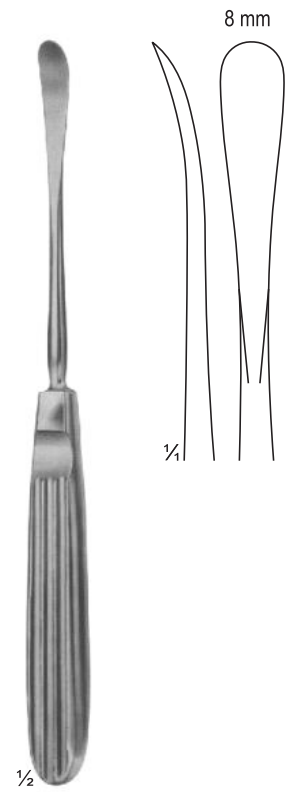

AS-11-182
COTLE
175 mm

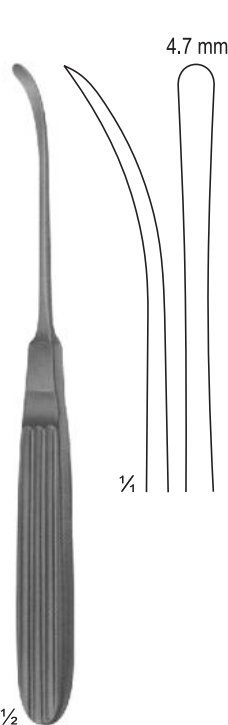

AS-11-183
LANDOT
175 mm

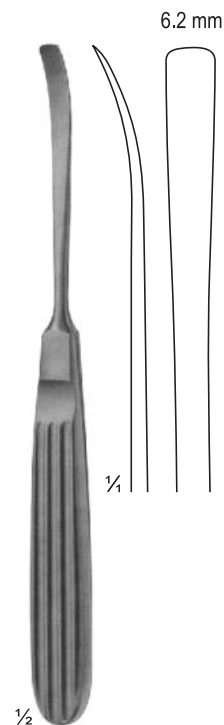

AS-11-184
CASPER
180 mm

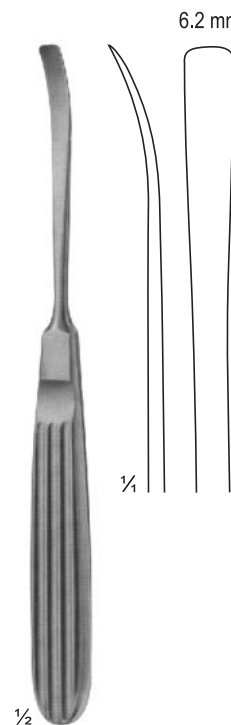

AS-11-185
CASPER
180 mm

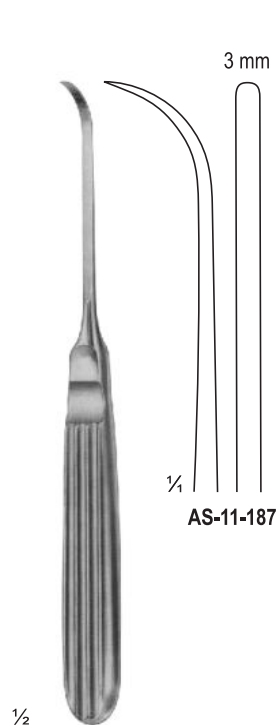

AS-11-186 - AS-11-188
170 mm

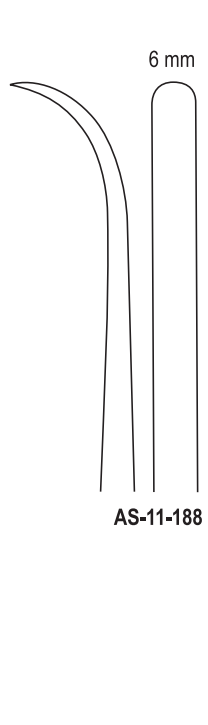

AS-11-188

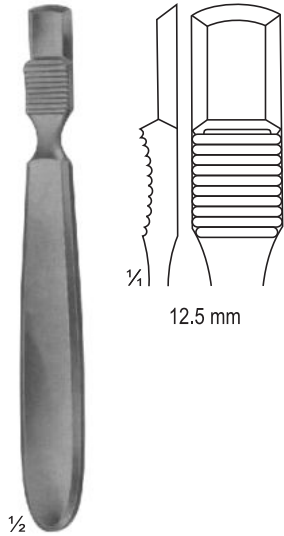

AS-11-189
FARABEU
140 mm

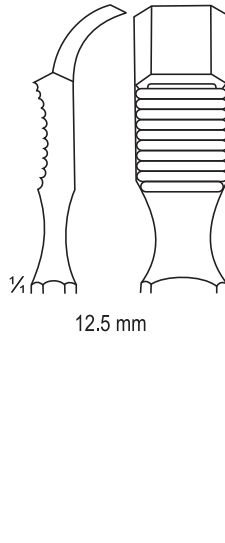

AS-11-190
FARABEU
140 mm

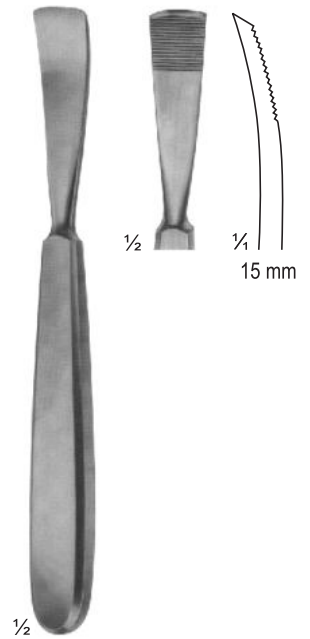

AS-11-191
JANSEN
165 mm

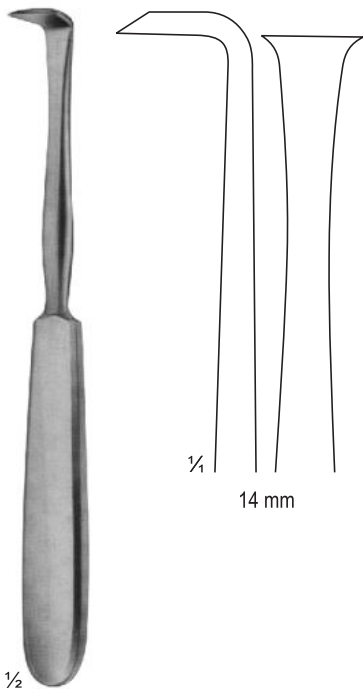

AS-11-192
LANGENBECK
180 mm

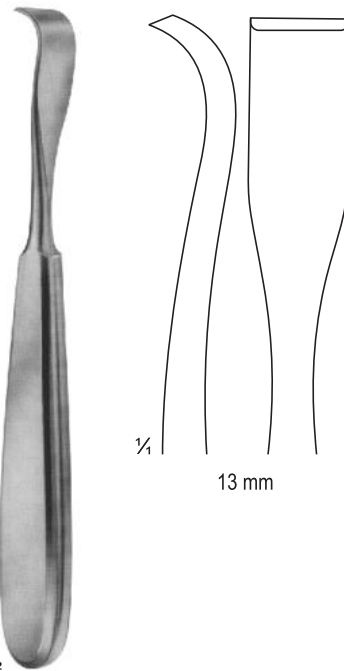

AS-11-193
SCHNEIDER
175 mm

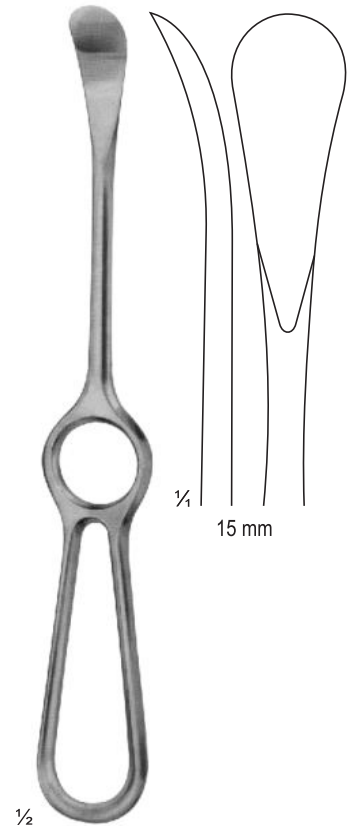

AS-11-194
SEDILLOT
215 mm

RASPATORIES WITH HARTPRESS-HANDLE



ASAMAR
SURGICAL

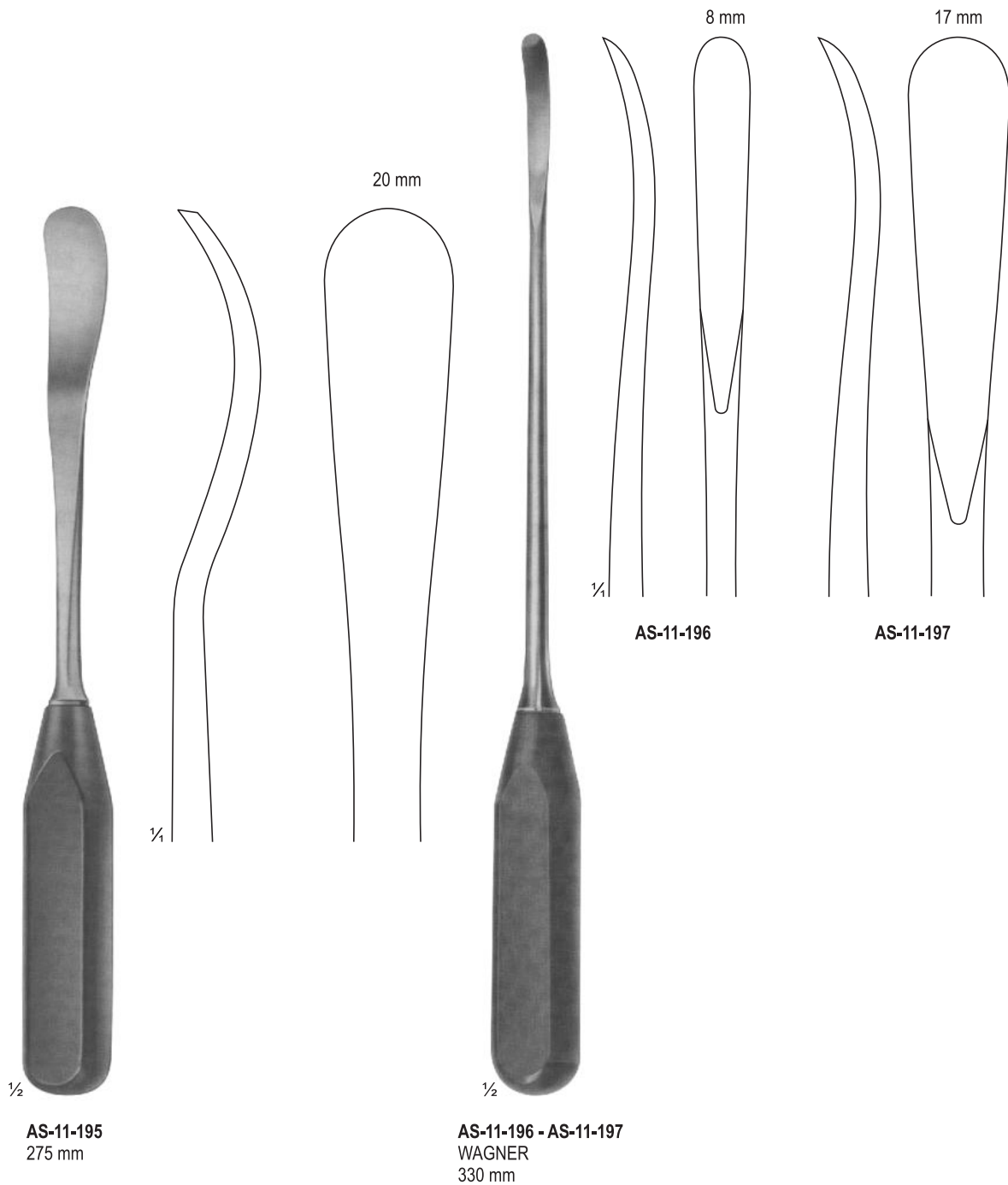

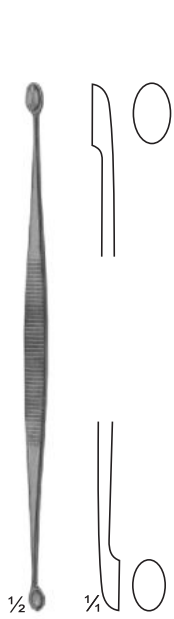

AS-11-198
JACOBSON
140 mm

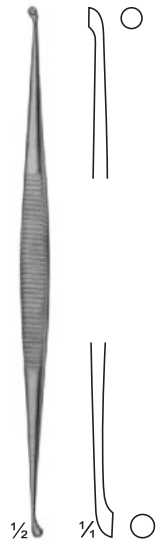

AS-11-199
MARTINI
140 mm

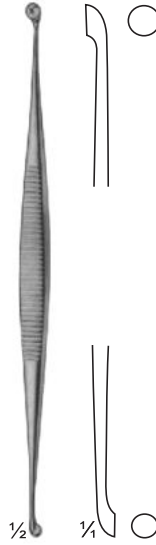

AS-11-200
MARTINI
140 mm



AS-11-201
WILLIGER
145 mm



AS-11-202
JANSEN
160 mm



AS-11-203
BARTH
180 mm

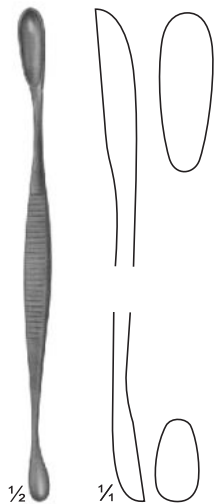

AS-11-204
VOLKMANN
130 mm

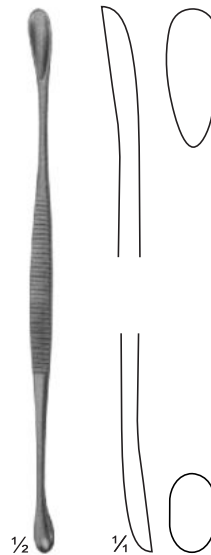

AS-11-205
VOLKMANN
145 mm

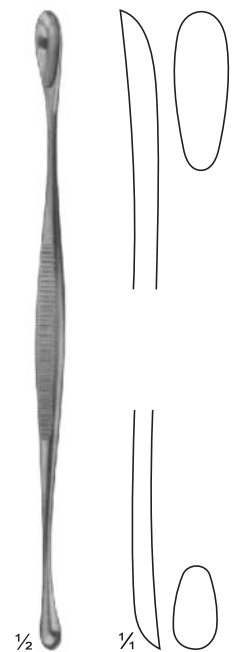

AS-11-206
VOLKMANN
170 mm



AS-11-207
JANSEN
160 mm



AS-11-208
HEMINGWAY
170 mm

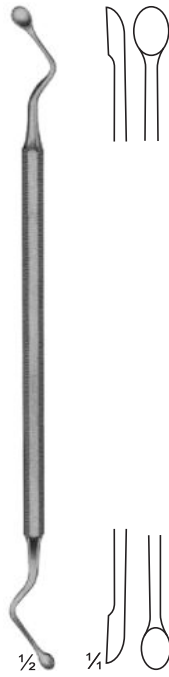

AS-11-209
HEMINGWAY
175 mm

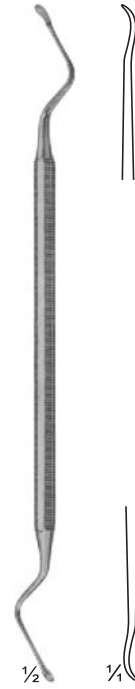

AS-11-210
LUCAS 180
mm

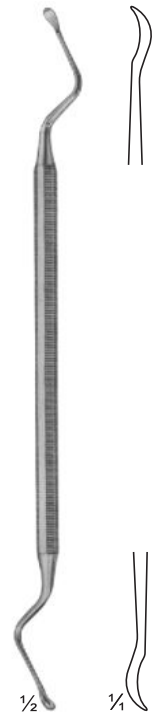

AS-11-211
LUCAS 185
mm

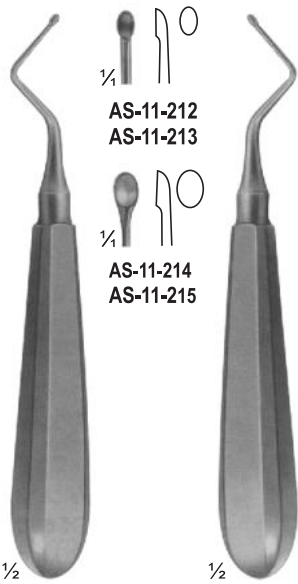

AS-11-212 - AS-11-213
KERPEL
145 mm



AS-11-214 - AS-11-215
KERPEL
145 mm

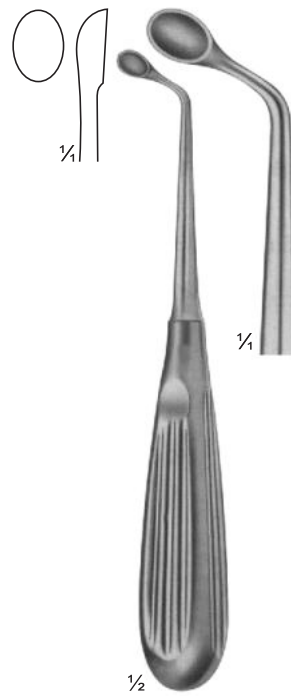

AS-11-216
UFFENDORDE
170 mm



AS-11-217
UFFENDORDE
170 mm

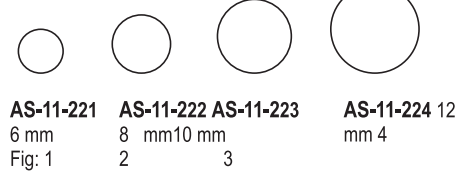
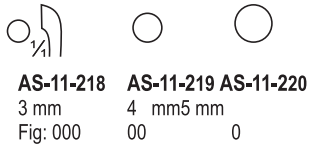

AS-11-218 - AS-11-224
 BRUNS
 165 mm

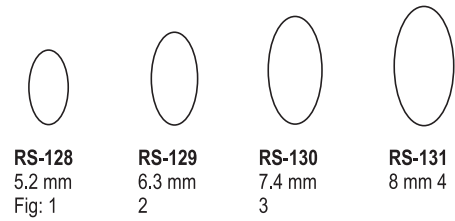
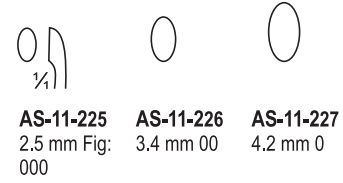

AS-11-225 - AS-11-231
 SCHEDE
 170 mm

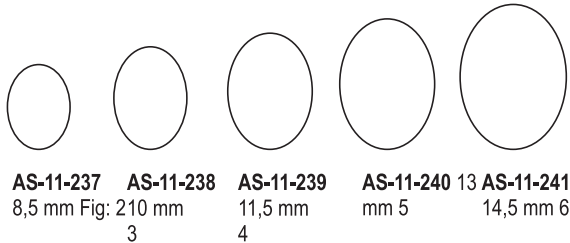
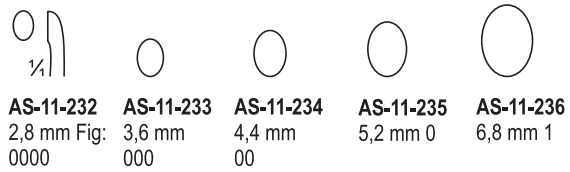

AS-11-232 - AS-11-241
 VOLKMANN
 170 mm

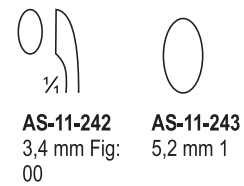

AS-11-242 - AS-11-243
 WILLIGER
 170 mm



-  **AS-11-244**
1.8 mm
-  **AS-11-245**
2 mm
-  **AS-11-246**
2.4 mm
-  **AS-11-247**
2.6 mm
-  **AS-11-248**
2.8 mm

1/2

AS-11-244 - AS-11-248
LEMPERT
215 mm







-  **AS-11-249**
4.4 mm Fig:
00
-  **AS-11-250**
5.2 mm Fig:
0
-  **AS-11-251**
6.8 mm Fig:
1

1/2

AS-11-249 - AS-11-251
HALLE
215 mm



-  **AS-11-252**
4.4 mm Fig:
0000
-  **AS-11-253**
5.2 mm Fig:
000
-  **AS-11-254**
5.2 mm Fig:
00
-  **AS-11-255**
6.8 mm Fig:
0

1/2

AS-11-252 - AS-11-255
DAUBENSPECK
200 mm



AS-11-256
3.6 mm
Fig: 000

AS-11-257
4.4 mm Fig:
00

AS-11-258
5.2 mm Fig:
0

AS-11-259
6.8 mm Fig:
1

1/2

AS-11-256 - AS-11-259
250 mm



AS-11-260
3.6 mm
Fig: 000

AS-11-261
4.4 mm Fig:
00



AS-11-262
5.2 mm Fig:
0

AS-11-263
6.8 mm Fig:
1

1/2

AS-11-260 - AS-11-263
250 mm



AS-11-264
3 mm

AS-11-265
4 mm

AS-11-266
5 mm

1/2

AS-11-264 - AS-11-266
BUSHE
250 mm

$\frac{1}{4}$ O
Fig. 1 AS-11-267

$\frac{1}{4}$ O
Fig. 1 AS-11-273

$\frac{1}{4}$ O
Fig. 1 AS-11-2179

O
Fig. 2 AS-11-268

O
Fig. 2 AS-11-274

O
Fig. 2 RS-1SF-11-2

O
Fig. 3 AS-11-269

O
Fig. 3 AS-11-275

O
Fig. 3 RS-1SF-11-2

O
Fig. 4 AS-11-270

O
Fig. 4 RS-1SF-11-2

O
Fig. 4 AS-11-282



O
Fig. 5 AS-11-271

O
Fig. 5 AS-11-277

O
Fig. 5 AS-11-283

O
Fig. 6 AS-11-272

O
Fig. 6 AS-11-278

O
Fig. 6 AS-11-284



MODELL USA
Oval, With Hollow
Handle AS-11-267 - AS-11-272 165 mm

MODELL USA
Oval, With Hollow Handle
AS-11-273 - AS-11-278
165 mm

MODELL USA
Oval, With Hollow Handle
AS-11-279 - AS-11-284
16 mm



ASAMAR
SURGICAL 

PAGE
242
TROCARS



AS-12-101
KLIMA ROSEGGER
35 X 1,8 mm
Sternal puncture needle

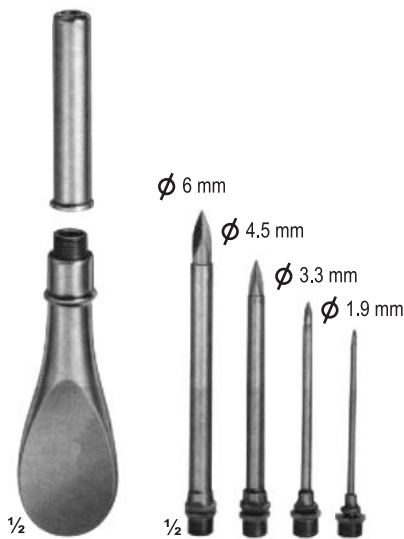

AS-12-102
Universal trocar with 4 tips



AS-12-103 - AS-12-107
Inside dime, Outside dime
AS-12-103 2,2 mm 3,0 mm
AS-12-104 3,0 mm 4,0 mm
AS-12-105 4,0 mm 5,0 mm
AS-12-106 5,0 mm 6,0 mm
AS-12-107 5,5 mm 6,5 mm
 for hydrocele and abdominal puncture



AS-12-108 - AS-12-111
Inside dime, Outside dime
AS-12-108 2,2 mm 3,0 mm
AS-12-109 3,0 mm 4,0 mm
AS-12-110 4,0 mm 5,0 mm
AS-12-111 5,0 mm 6,0 mm for abdominal puncture, with stop-cock and lateral drain

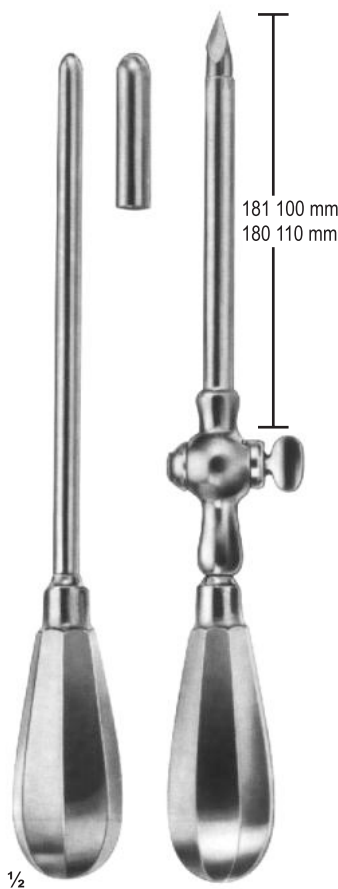

AS-12-112 - AS-12-113
Inside dime, Outside dime
AS-12-112 6.5 mm 8 mm
AS-12-113 9 mm 10 mm
 Empyema trocar

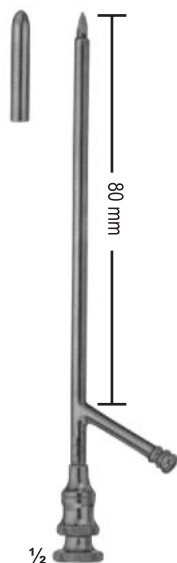

AS-12-114 - AS-12-117
Inside dime, Outside dime
AS-12-114 3 mm 4 mm
AS-12-115 3.6 mm 4.6 mm
AS-12-116 4.3 mm 5.3 mm
AS-12-117 5 mm 6 mm
 Gall bladder trocars



AS-12-118
PIERCE
Antrum trocar
4 mm



AS-12-119
COAKLEY
Antrum trocar
3 mm



ASAMAR
SURGICAL 

PAGE
243-253
VAGINAL SPECULA

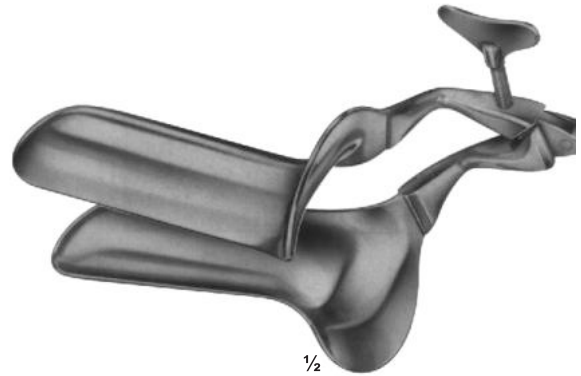

AS-13-102 - AS-13-105 COLLIN
 AS-13-102 100/90mm 28 mm
 AS-13-103 100/90mm 32 mm
 AS-13-104 105/95mm 35 mm
 AS-13-105 115/105mm 40 mm
 mm Total length/working length

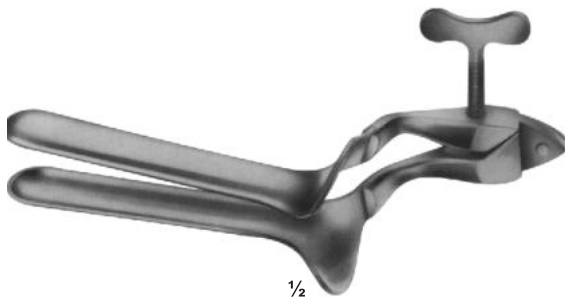

AS-13-106
 COLLIN
 for virgins
 95/85 x 18 mm



AS-13-107
 CUSCO
 for virgins
 75 x 17 mm



AS-13-108
 CUSCO
 for virgins
 75 x 17 mm



AS-13-109 - AS-13-111
 CUSCO
 AS-009 92x23-25 mm
 AS-010 100x25-27 mm
 AS-011 110x27-30 mm



1/2

AS-13-112 - AS-13-115
CUSCO STANDARD
AS-13-112 80X24 mm
AS-13-113 80X32 mm
AS-13-114 90X36 mm
AS-13-115 110X37 mm



1/2

AS-13-116 - AS-13-119
CUSCO
AS-13-116 80X24 mm
AS-13-117 80X32 mm
AS-13-118 90X36 mm
AS-13-119 110X37 mm



1/2

AS-13-120 - AS-13-122
CUSCO
AS-13-120 80X24 mm
AS-13-121 80X32 mm
AS-13-122 115X36 mm



1/2

AS-13-123 - AS-13-124
SEYFFERT
AS-13-123 100X24 mm
AS-13-124 110X32 mm
230 mm



1/2

AS-13-125
SEMM
for children
and virgins
180 mm



AS-13-126 - AS-13-128
GRAVE
AS-13-126 75X20 mm
AS-13-127 95X30 mm
AS-13-128 105X33 mm



AS-13-129 - AS-13-130
AS-13-129 100X22 mm
AS-13-130 120X25 mm



AS-13-131 - AS-13-132 BRIESKY
AS-13-131 72X25 mm / 77X30 mm
AS-13-132 75X30 mm / 92X38 mm
170 mm



AS-13-133 - AS-13-134
BREISKY
AS-13-133 100X22 mm
77 X30 mm
140 mm
AS-13-134 120X25 mm
92 X38 mm
170 mm



AS-13-135 - AS-13-137
SEIDL
AS-13-135 80X8 mm
AS-13-136 80X10 mm
AS-13-137 90X14 mm
For children and infants
170 mm



AS-13-138
KRISTELLER
70X15 mm, (170 mm)
For children



AS-13-139 - AS-13-141 SIMS
AS-13-139 70X26 mm 75 X30 mm
125 mm
AS-13-140 75X30 mm 80 X85 mm
150 mm
AS-13-141 80X36 mm 90 X40 mm
175 mm

VAGINAL SPECULA, UPPER & LOWER BLADES



ASAMAR
SURGICAL



AS-13-147 75X10 mm
175 mm

AS-13-151 70X15 mm
175 mm

AS-13-148 75X23 mm
180 mm

AS-13-152 70X27 mm
180 mm

AS-13-149 80X25 mm
180 mm

AS-13-153 75X30 mm
180 mm

AS-13-150 100X32 mm
185 mm

AS-13-154 90X36 mm
185 mm

AS-13-142 - AS-13-146
KRISTELLER
AS-13-142 110X18 mm
AS-13-143 110X20 mm
AS-13-144 110X27 mm
AS-13-145 110X30 mm
AS-13-146 110X36 mm
220 mm

AS-13-147 - AS-13-150
KRISTELLER
Upper blades

AS-13-151 - AS-13-154
KRISTELLER
Lower blades

VAGINAL SPECULA, UPPER & LOWER BLADES



ASAMAR
SURGICAL

AS-13-155 115X14 mm
215 mm

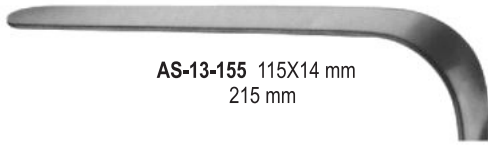

AS-13-156 115X23 mm
215 mm

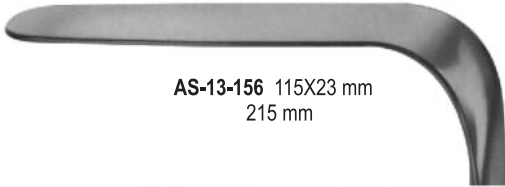

AS-13-157 115X16 mm
220 mm

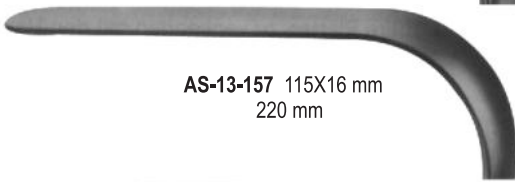

AS-13-158 115X26 mm
220 mm

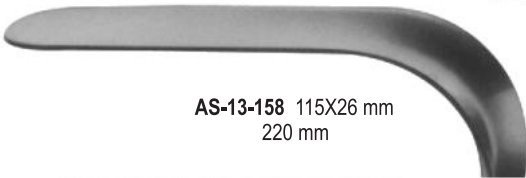

AS-13-159 120X30 mm
225 mm



AS-13-160 110X18 mm
215 mm



AS-13-161 110X27 mm
215 mm

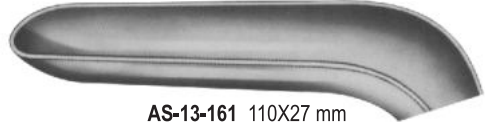

AS-13-162 110X20 mm
220 mm



AS-13-163 110X30 mm
220 mm



AS-13-164 110X36 mm
225 mm



AS-13-155 - AS-13-159
KRISTELLER
Upper blades



VAGINAL SPECULA, UPPER & LOWER BLADES



ASAMAR
SURGICAL 

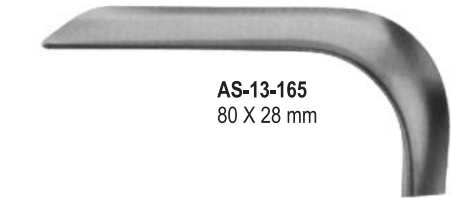

AS-13-165
80 X 28 mm



AS-13-166
85 X 35 mm

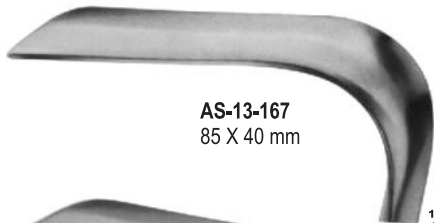

AS-13-167
85 X 40 mm



Slightly Concave

AS-13-165 - AS-13-167
KRISTELLER
205 mm



AS-13-168
76 X 38 mm



AS-13-169
89 X 38 mm

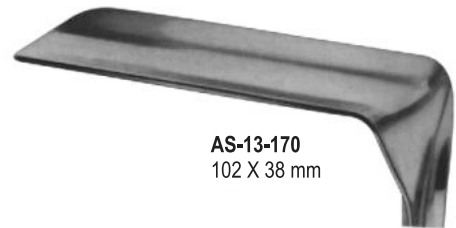

AS-13-170
102 X 38 mm



Slightly Concave

AS-13-168 - AS-13-170
JACKSON
175 mm



1/2
AS-13-171
BRAUN 180
mm



1/2
AS-13-172
BRAUN 180
mm



AS-13-173
MATHIEU
For
children
and virgins
210 mm



AS-13-174
MATHIEU
for children and
virgins fitting
210 mm



AS-13-175
Handle with cold light
carrier for upper
blades 280 mm

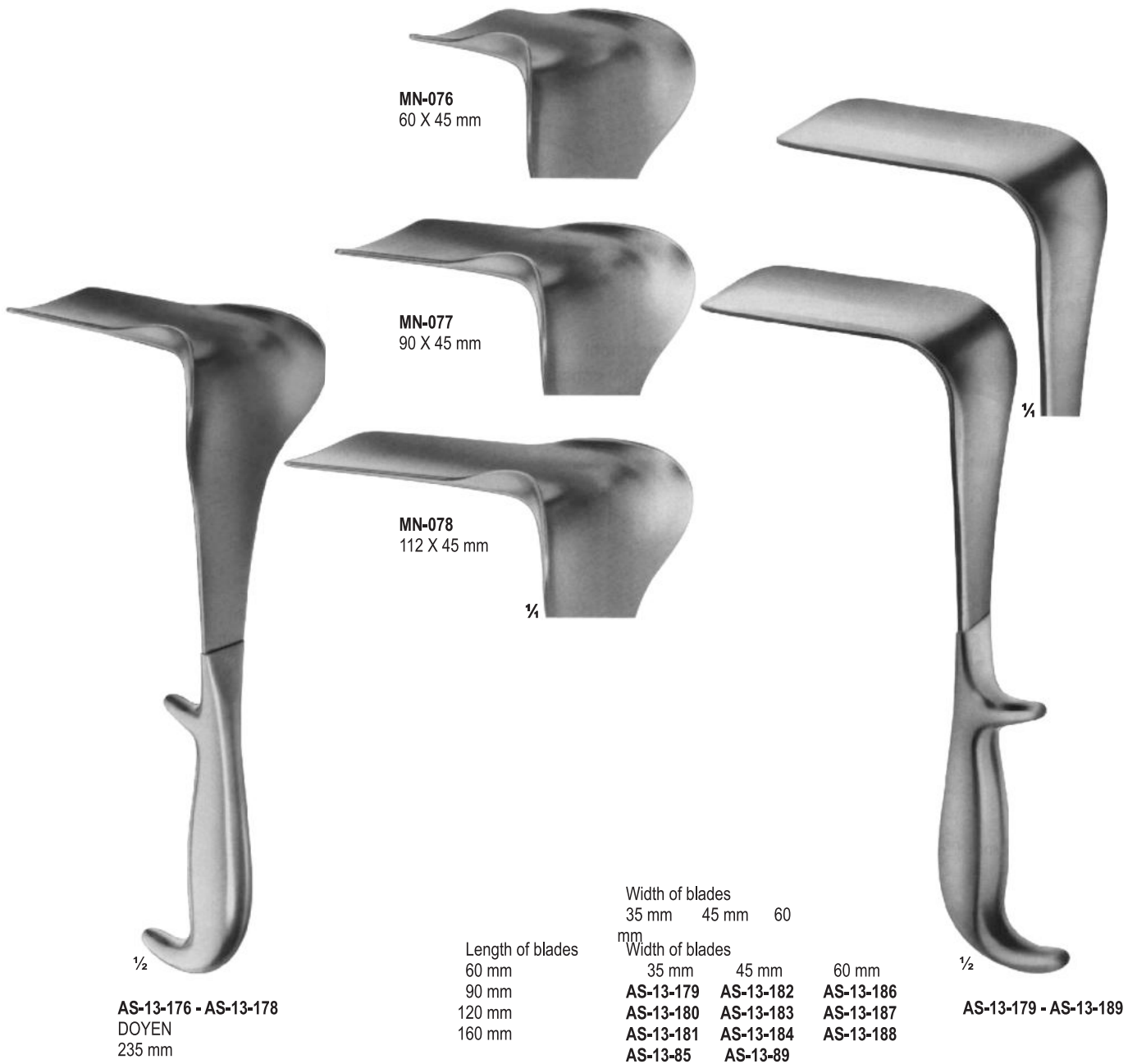



1/2

AS-13-190 - AS-13-194
BREISKY
WIENER MODELL/
VIENNA PATTERN
AS-13-190 100 X 20 mm
AS-13-191 100 X 25 mm
AS-13-192 100 X 30 mm
AS-13-193 100 X 35 mm
AS-13-194 100 X 40 mm
300 mm



1/2

AS-13-195 - AS-13-199
BREISKY
WIENER MODELL/
VIENNA PATTERN
AS-13-195 130 X 20 mm
AS-13-196 130 X 25 mm
AS-13-197 130 X 30 mm
AS-13-198 130 X 35 mm
AS-13-199 130 X 40 mm
320 mm



1/2

AS-13-200
DOYEN
lateral
speculum 80 x
30 mm
250 mm



1/2

AS-13-201
SIMON
115 X 22
mm 275 mm



1/2

AS-13-202 AUVARD
65 X 38 mm - 28
mm 1,530 kg
with fixed weight
230 mm



1/2

AS-13-203 - AS-13-204
AUVARD
AS-13-203 75 X 42 mm
(40 mm)
AS-13-204 105 X 43
mm (40 mm)
with detachable wight
230 mm



AS-13-205
80 X 30

AS-13-208
55 X 40 - 60 mm

AS-13-206
85 X 35

AS-13-209
70 X 45 - 70 mm

AS-13-207
85 X 40



AS-13-210
80 X 30 mm



AS-13-214
65 X 30 mm



AS-13-211
85 X 33 mm



AS-13-215
75 X 35 mm



AS-13-212
100 X 38 mm



AS-13-216
85 X 35 mm



AS-13-213
110 X 42 mm



AS-13-217
95 X 35 mm

SCHERBACK
AS-13-210 - AS-13-217
Set consisting of:
2 handle
2 blades





ASAMAR
SURGICAL 

PAGE
254-288
WOUND
RETRACTORS

FINE WOUND RETRACTORS (DURA- AND SKIN RETRACTORS)



ASAMAR
SURGICAL

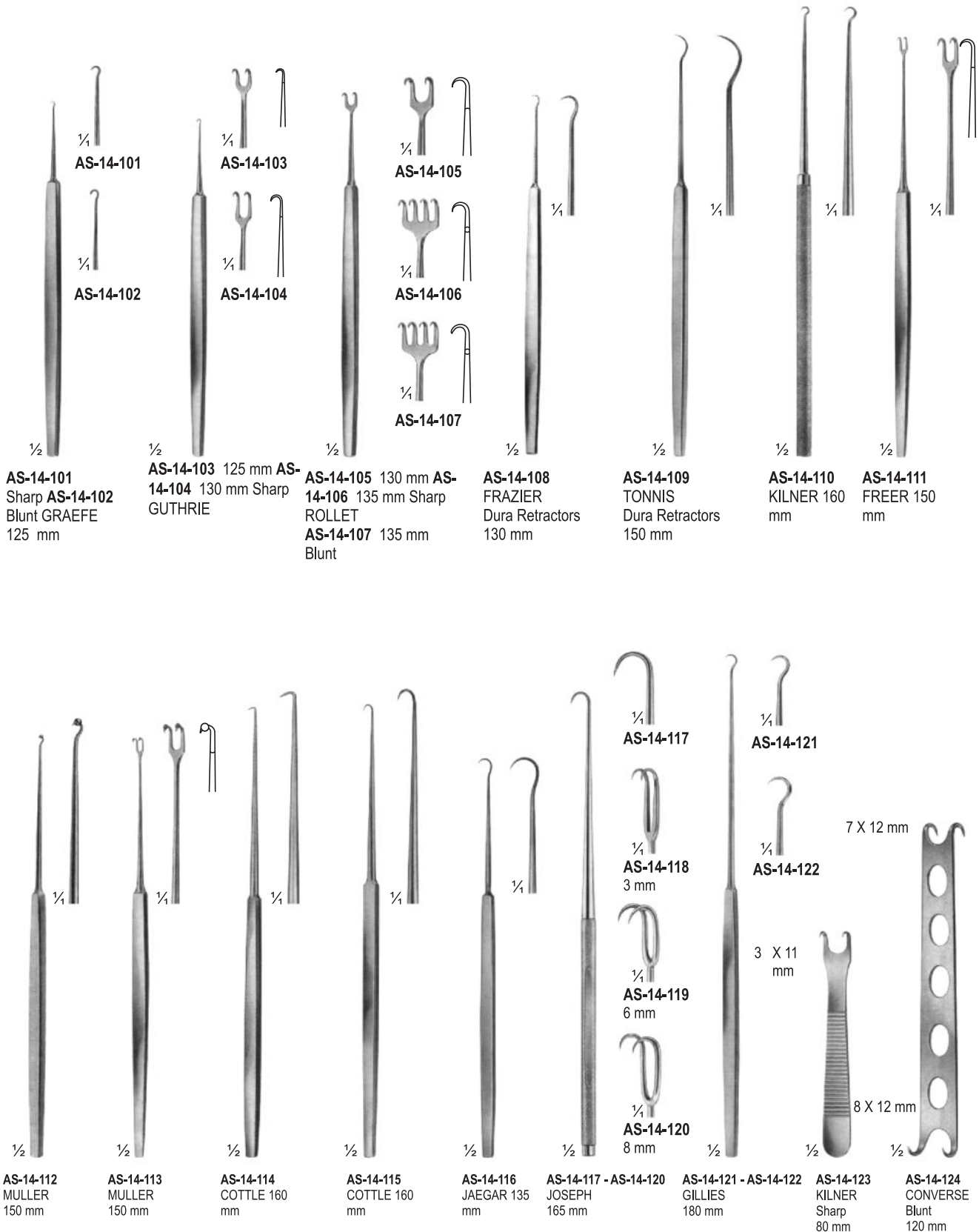

WOUND - TRACHEA RETRACTORS

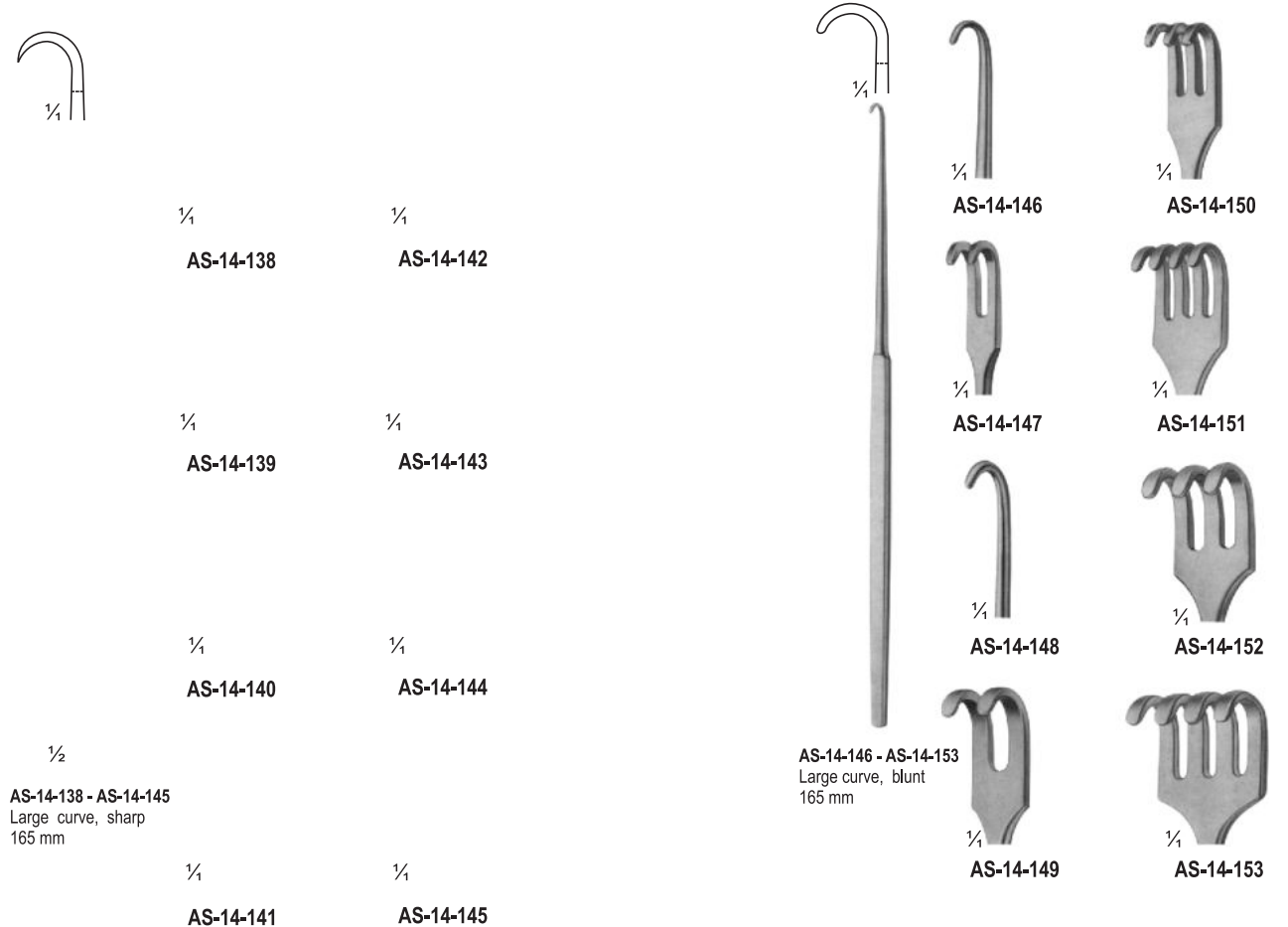
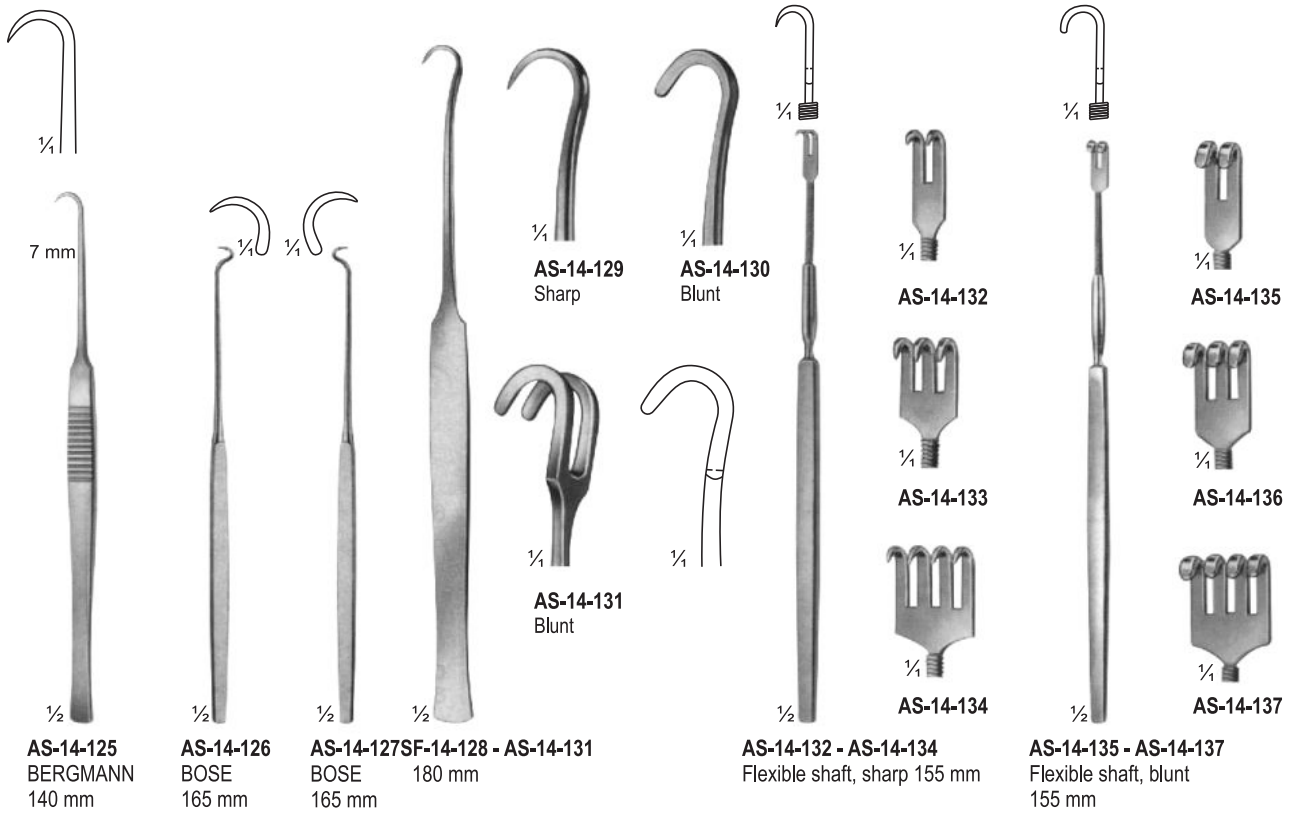

RETRACTORS WITH TREANGLE HANDLE



ASAMAR
SURGICAL

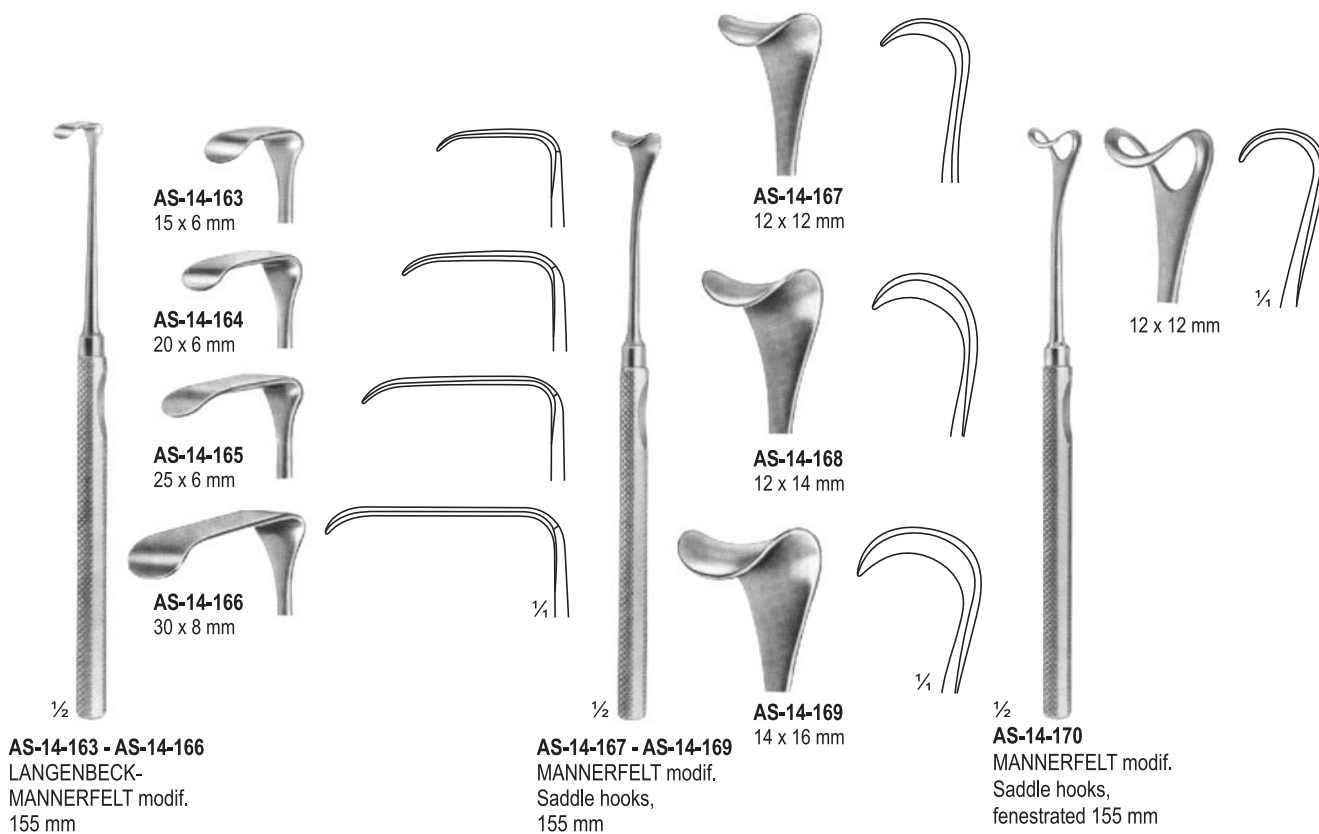
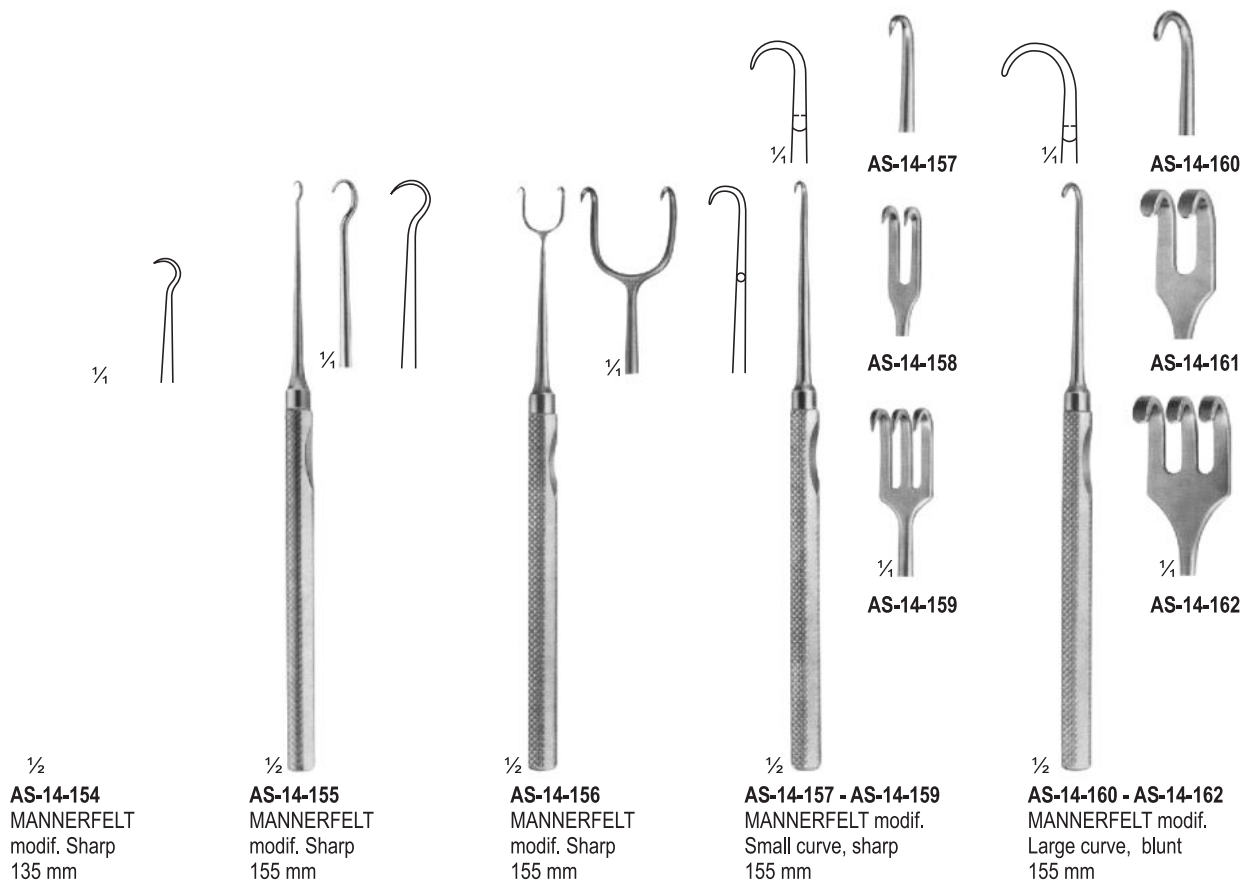

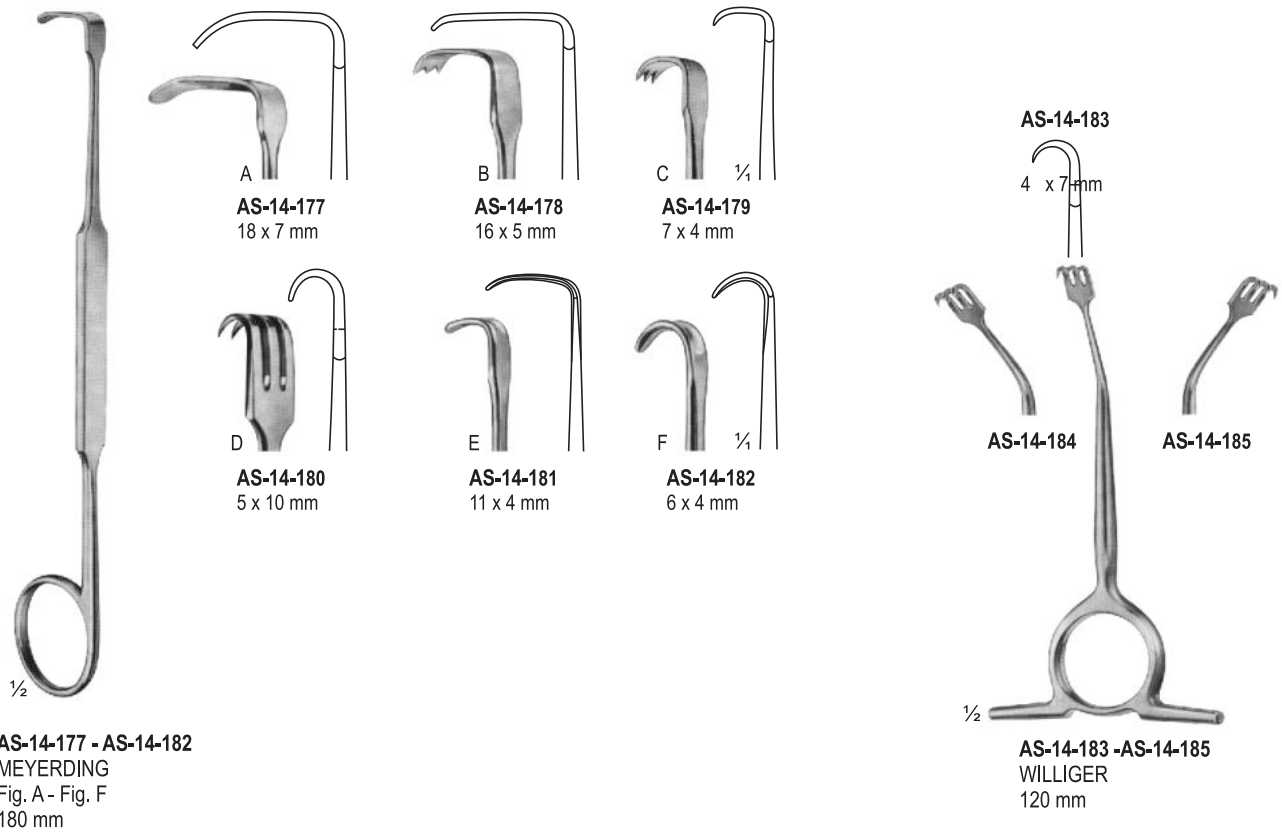
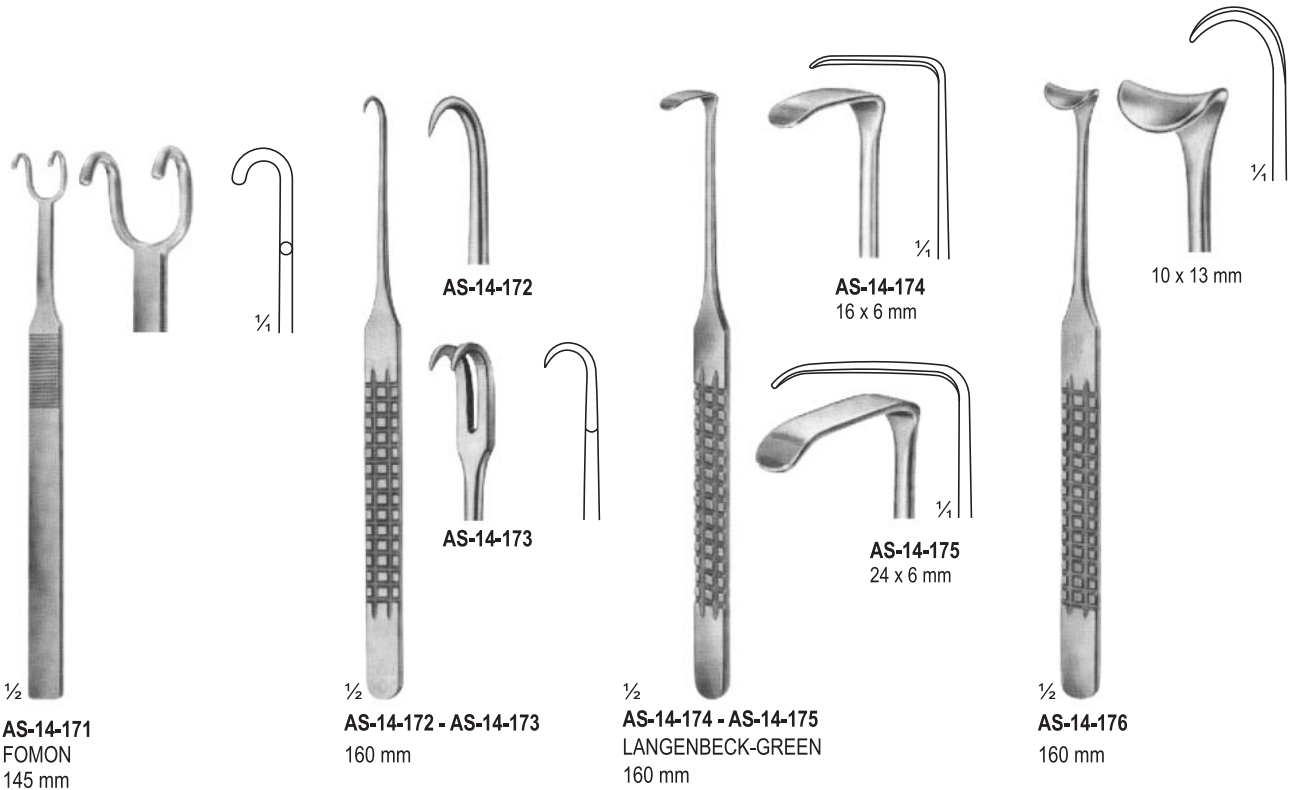



1/2
AS-14-186
EMMET
Fistula
hook 220
mm



1/2
AS-14-187
SIMON
Fistula
hook 220
mm

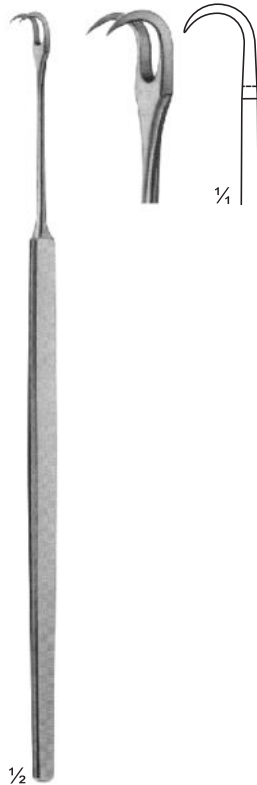

1/2
AS-14-188
SIMON
Fistula hook
220 mm



1/2
AS-14-189
LANGE
Fistula hook
230 mm

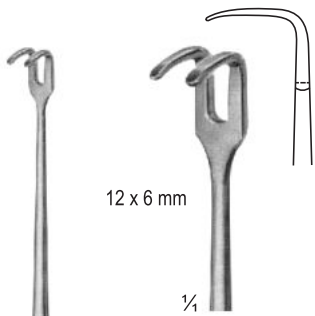

12 x 6 mm

1/4

AS-14-190

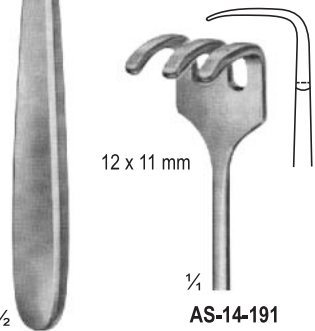

12 x 11 mm

1/4

AS-14-191

AS-14-190 - AS-14-191
Tendon hooks
175 mm

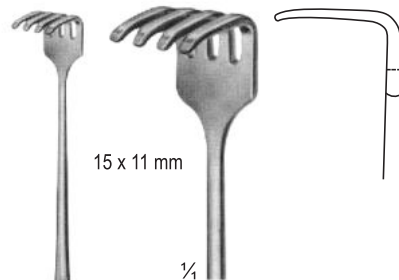

15 x 11 mm

1/4

1/2
AS-14-192
KLAPP Tendon
hooks 175 mm

WOUND AND VEIN RETRACTORS

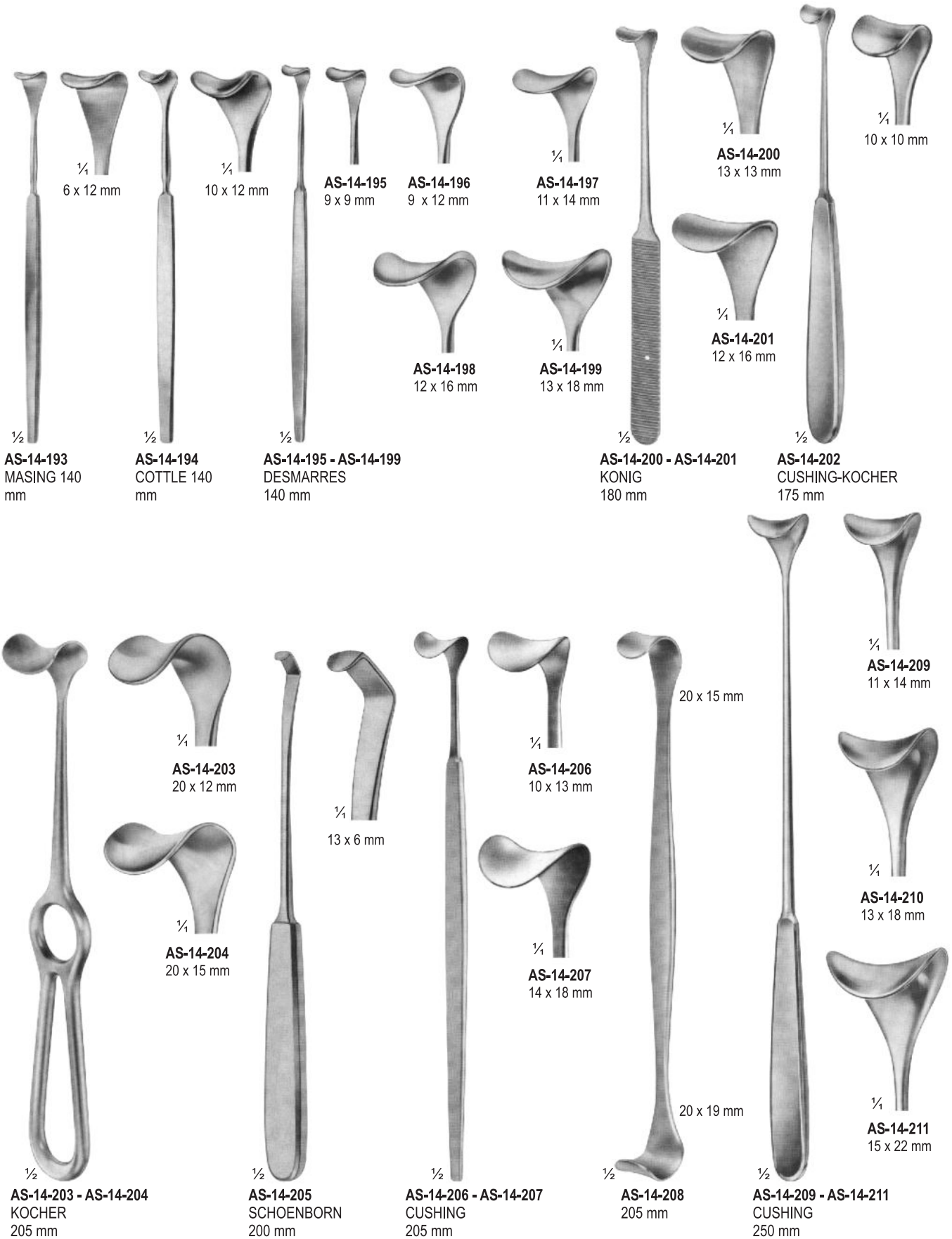

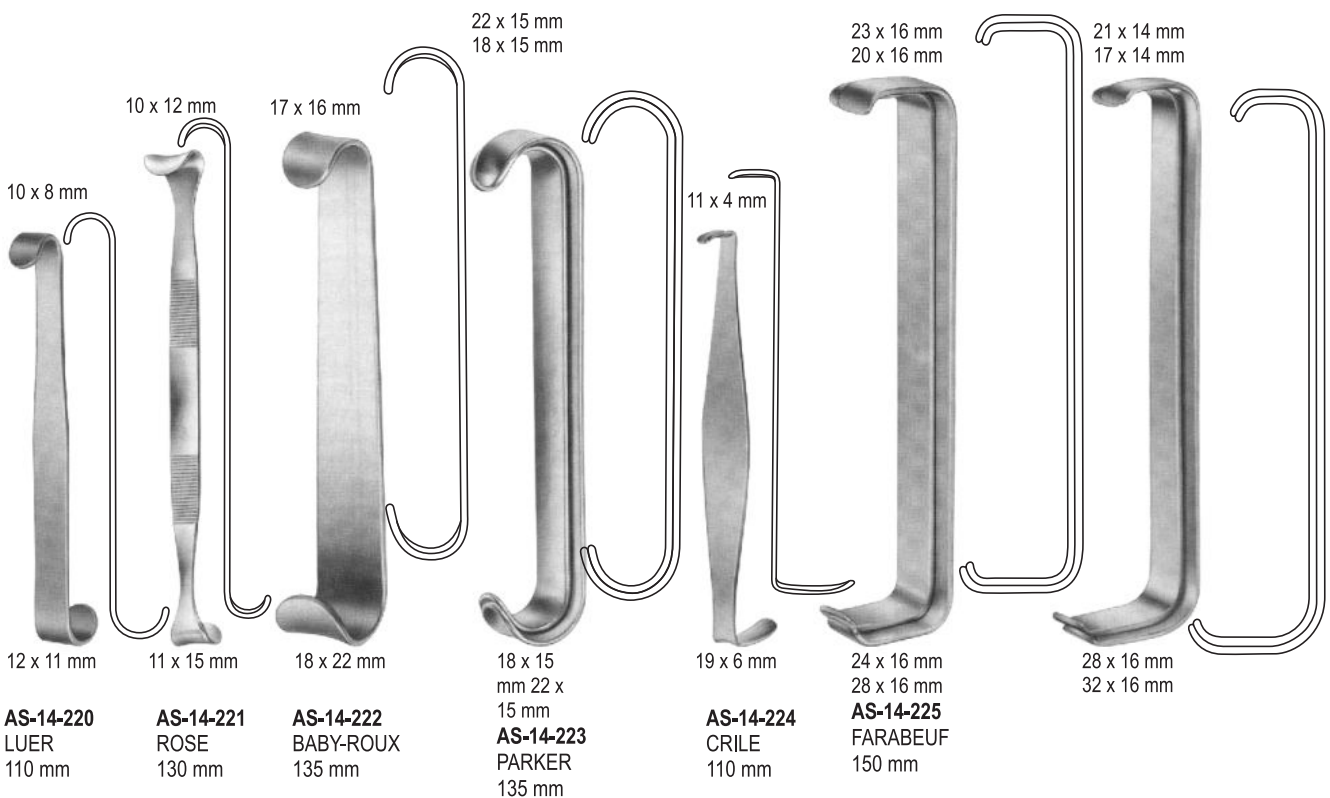
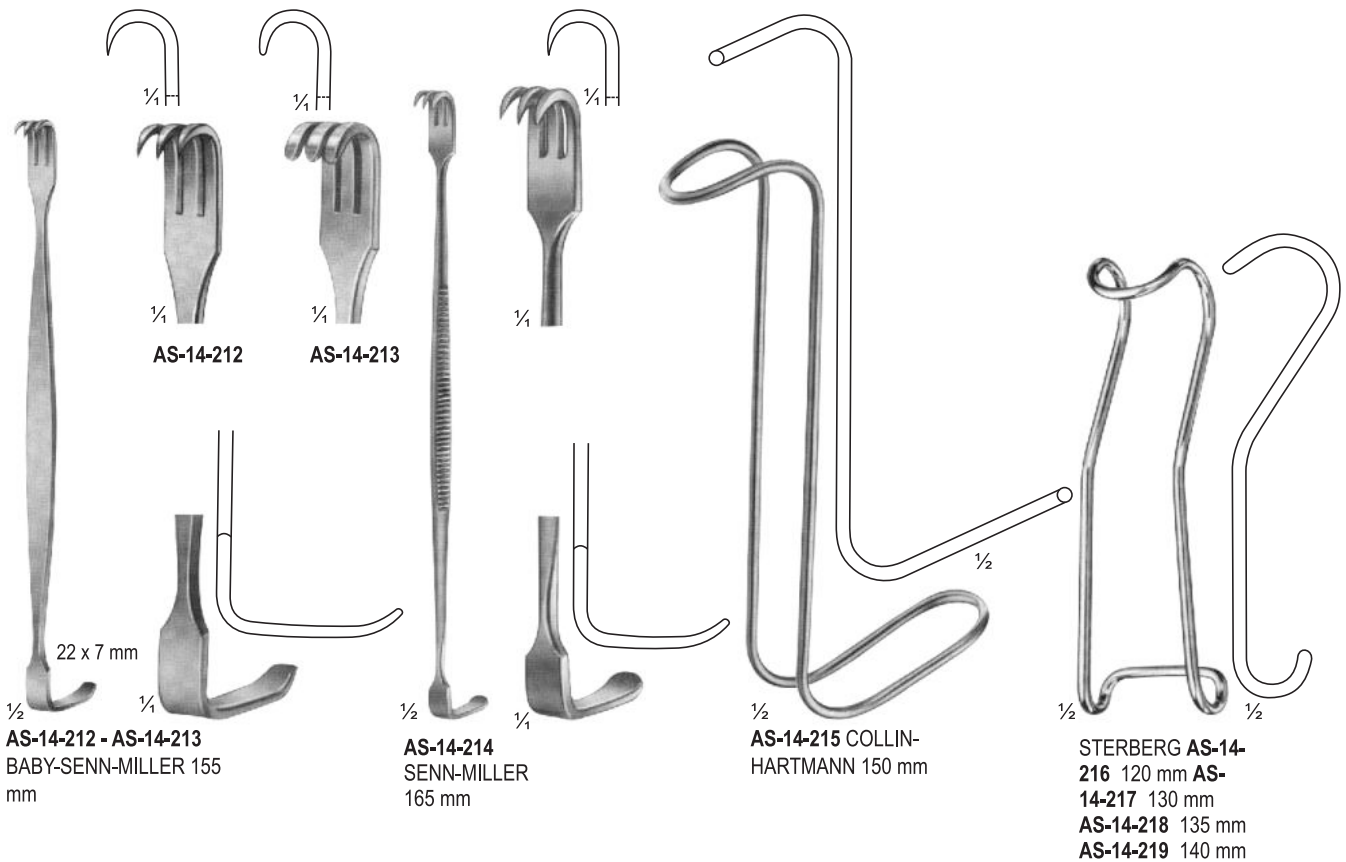

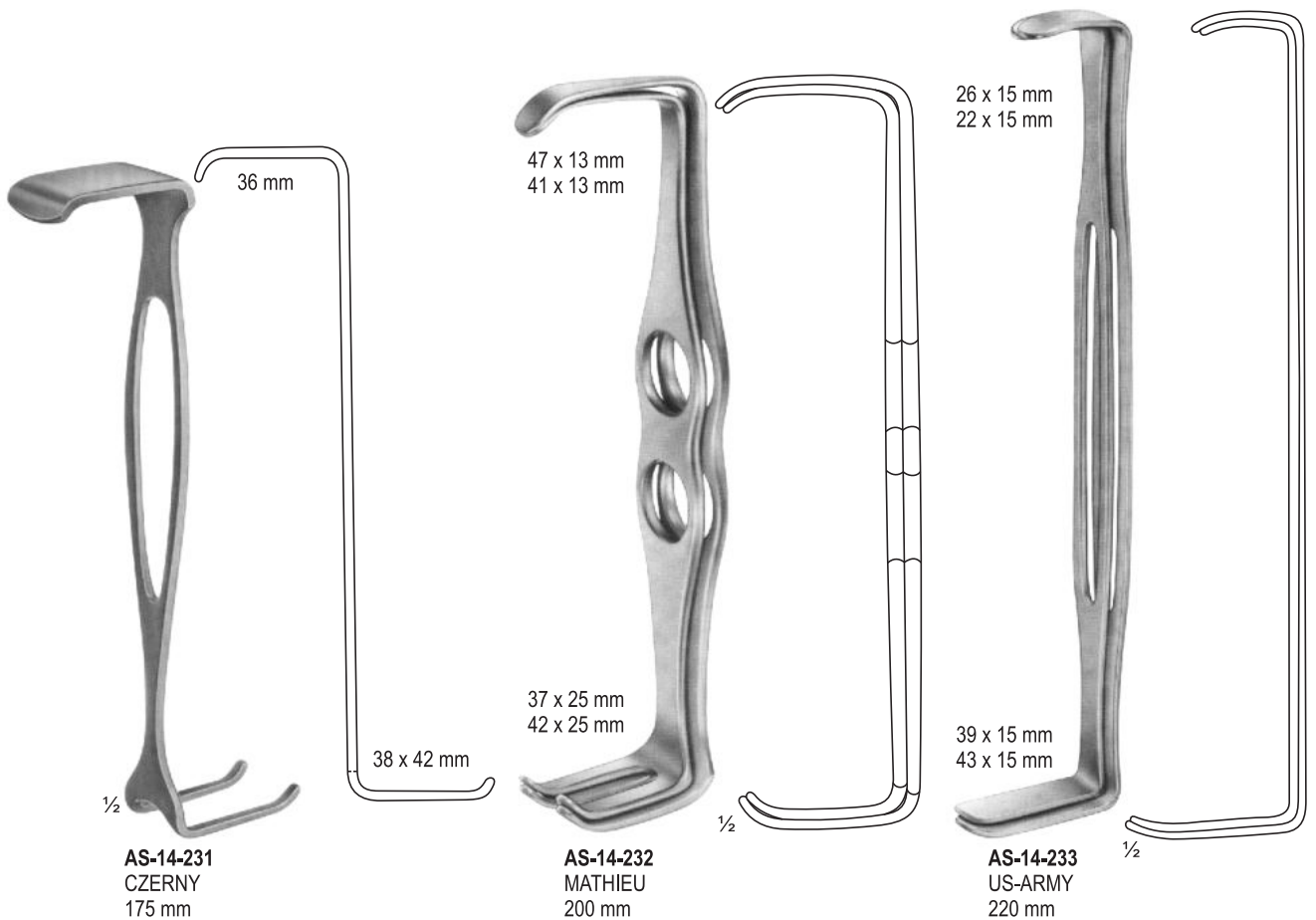
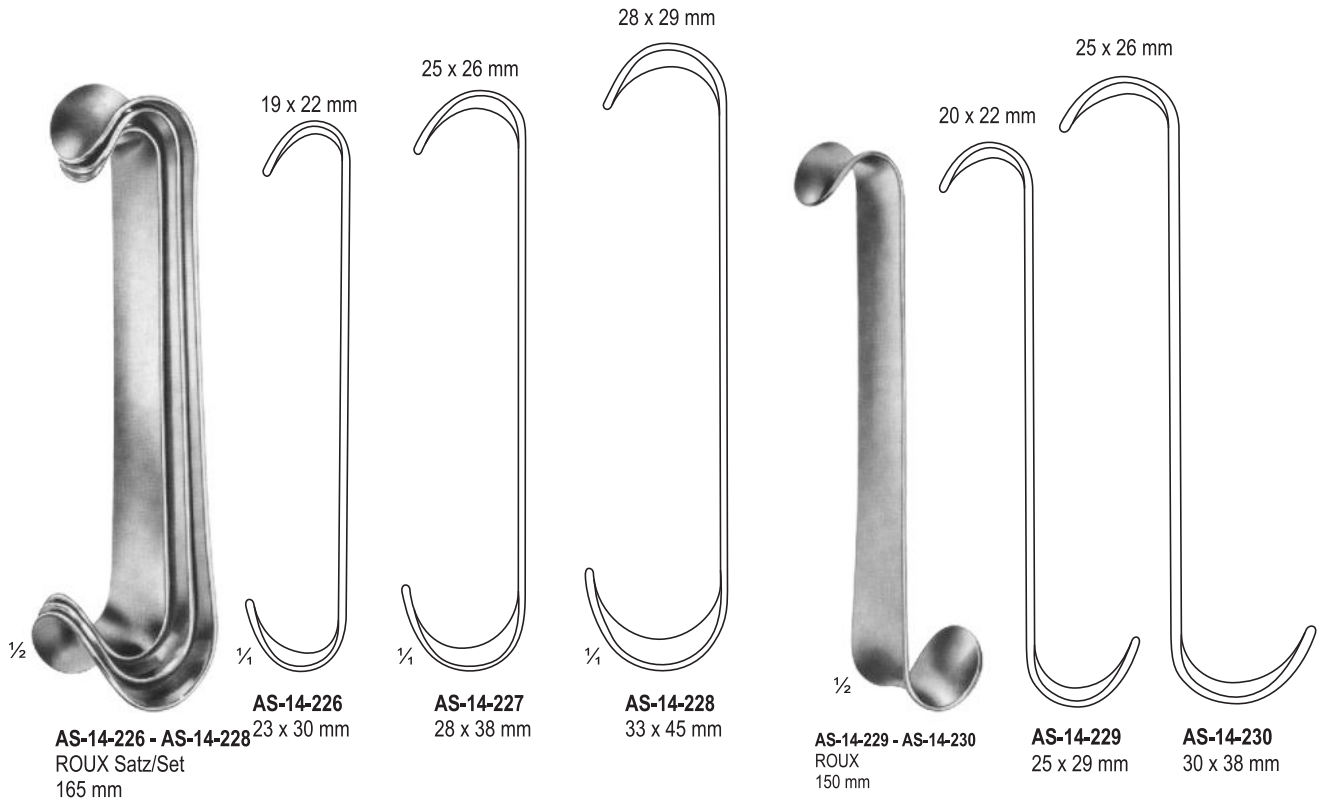



AS-14-234
KOCHER
Sharp
205 mm



AS-14-235
KOCHER
Sharp
220 mm



AS-14-236
KOCHER
Blunt
220 mm



AS-14-237
VOLKMANN
Sharp
220 mm



AS-14-238
VOLKMANN
Sharp
220 mm



AS-14-239 - AS-14-246
VOLKMANN
225 mm

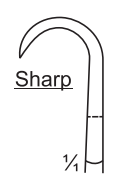

AS-14-239
9 x 8 mm



AS-14-240
9 x 13 mm



AS-14-241
9 x 19 mm



AS-14-242
9 x 29 mm

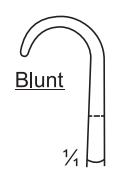

AS-14-243
8,5 x 8 mm



AS-14-244
8,5 x 13 mm



AS-14-245
8,5 x 19 mm



AS-14-246
8,5 x 29 mm

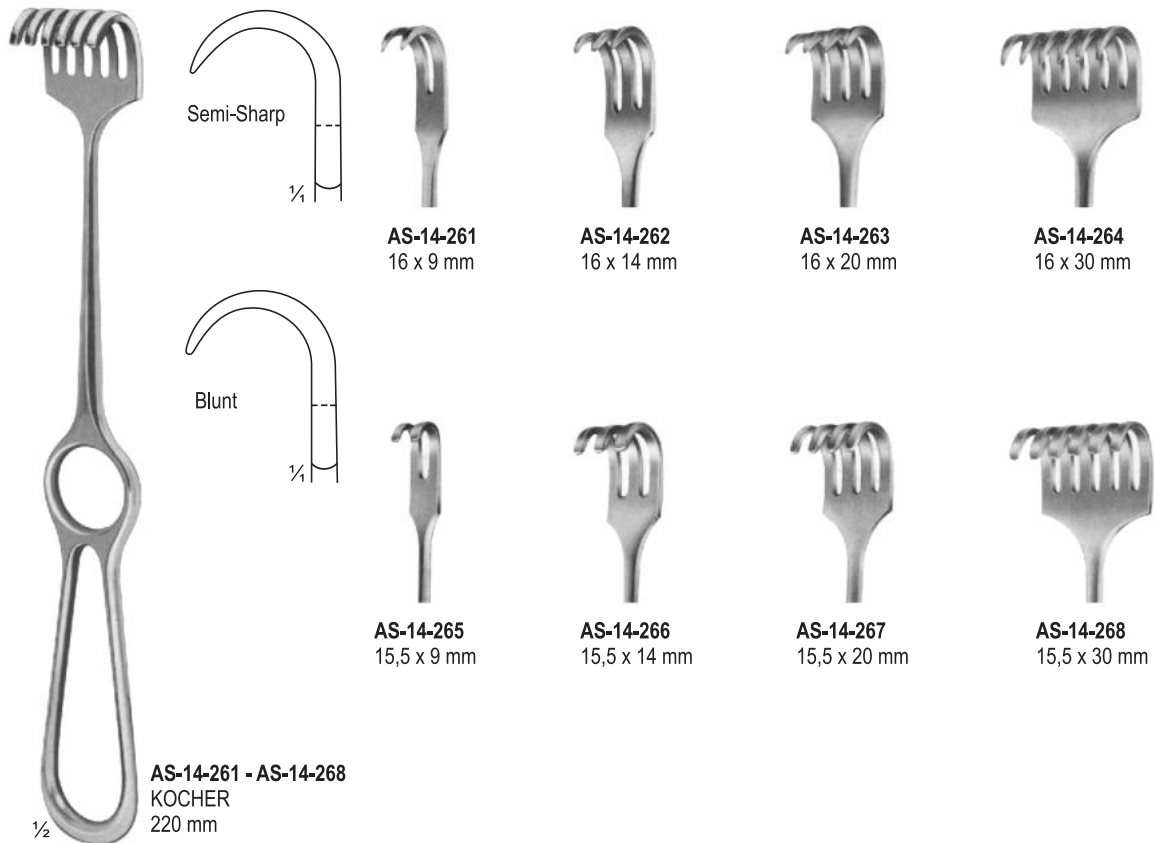
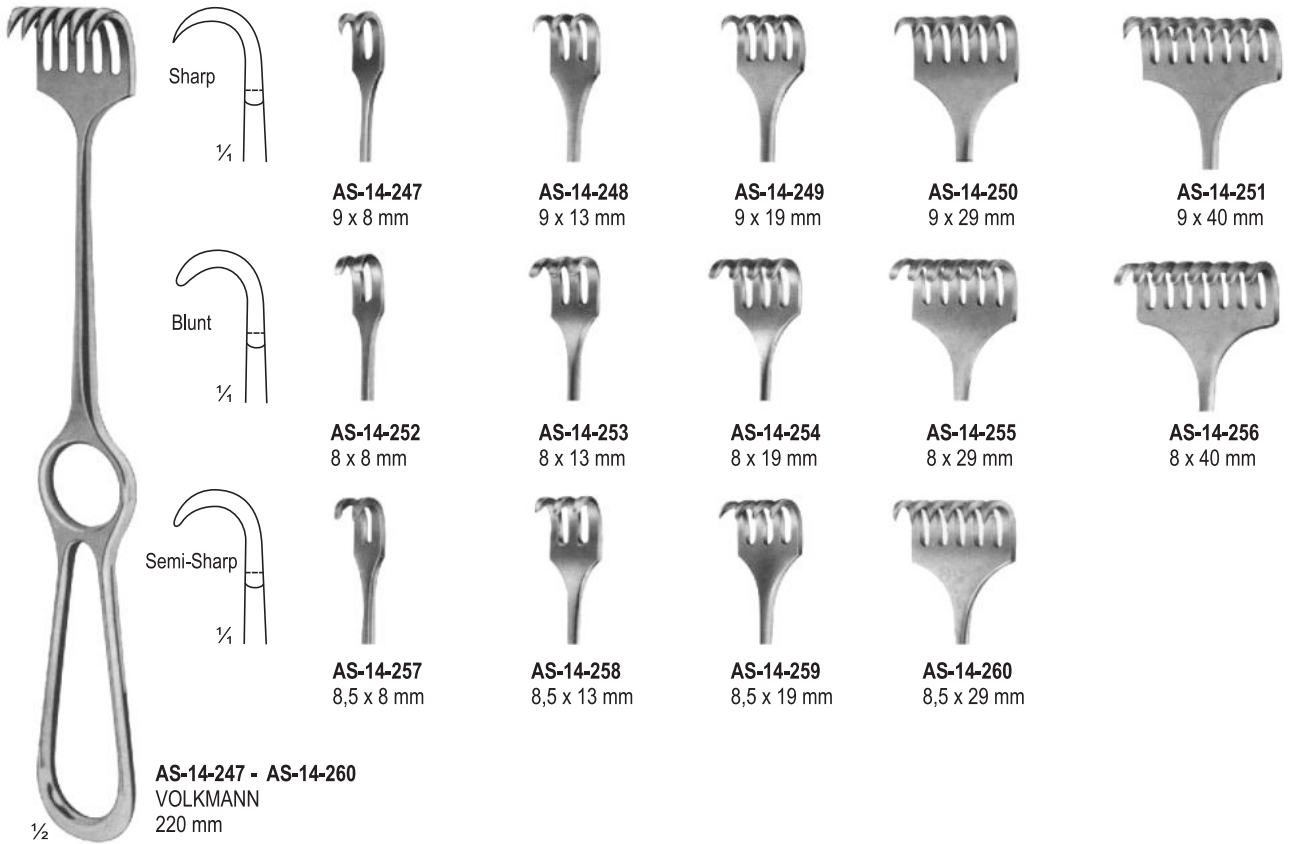



AS-14-268 - AS-14-270
KORTE
240 mm



AS-14-269
8 Prongs, blunt



AS-14-270
8 Prongs, sharp



AS-14-271 - AS-14-274
ISRAEL
255 mm

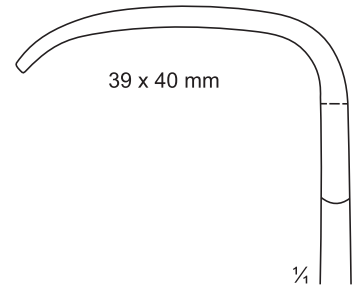

AS-14-271
4 Prongs, blunt

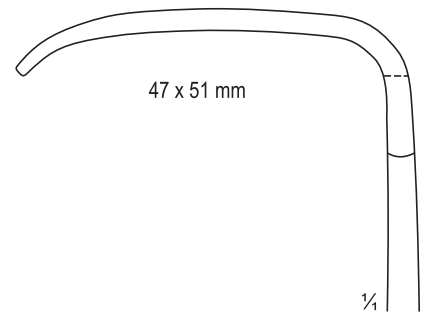

AS-14-272
5 Prongs, blunt

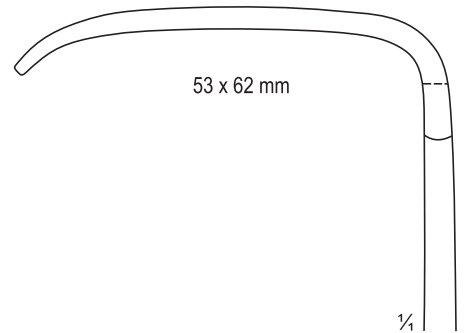

AS-14-273
6 Prongs, blunt

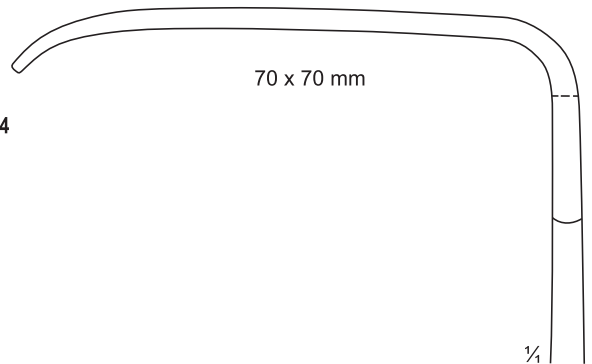

AS-14-274
6 Prongs, blunt

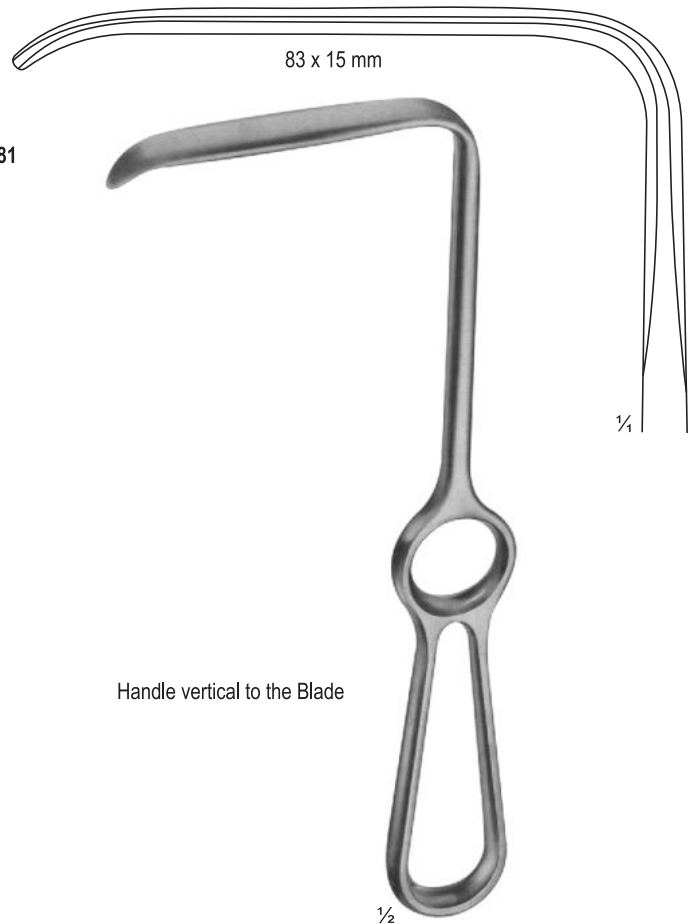

AS-14-275 - AS-14-280
LANGENBECK
210 mm

AS-14-275 28 x 10 mm
AS-14-276 28 x 14 mm
AS-14-277 33 x 14 mm
AS-14-278 28 x 16 mm
AS-14-279 40 x 10 mm
AS-14-280 40 x 13 mm

AS-14-281 - AS-14-287
KOCHER-LANGENBECK
215 mm

AS-14-281 25 x 6 mm
AS-14-282 35 x 8 mm
AS-14-283 35 x 11 mm
AS-14-284 35 x 15 mm
AS-14-285 41 x 11 mm
AS-14-286 55 x 11 mm
AS-14-287 70 x 14 mm

AS-14-288
LANGENBECK
215 mm



AS-14-289 - AS-14-293
KOCHER
230 mm

1/2

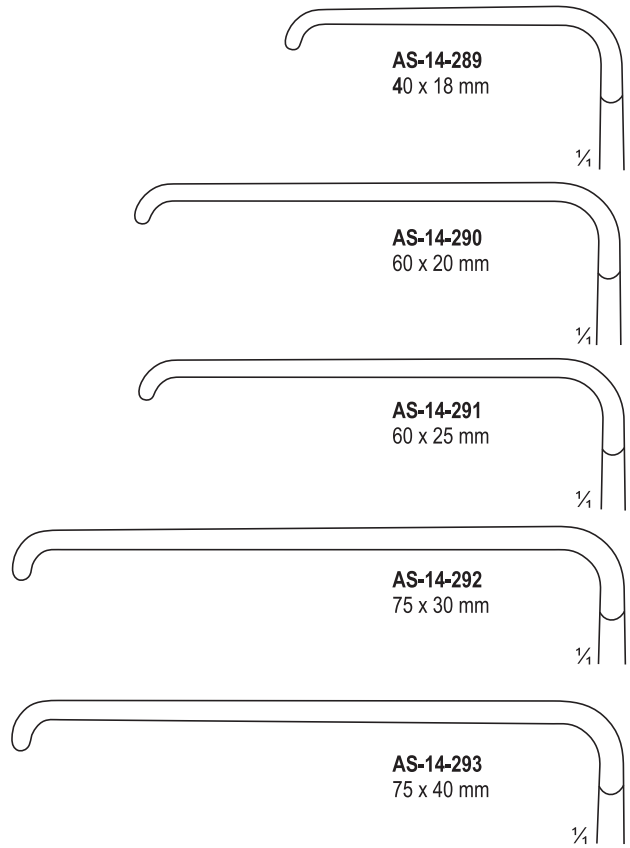

AS-14-294 - AS-14-296
SAUERBRUCH
225 mm

1/2

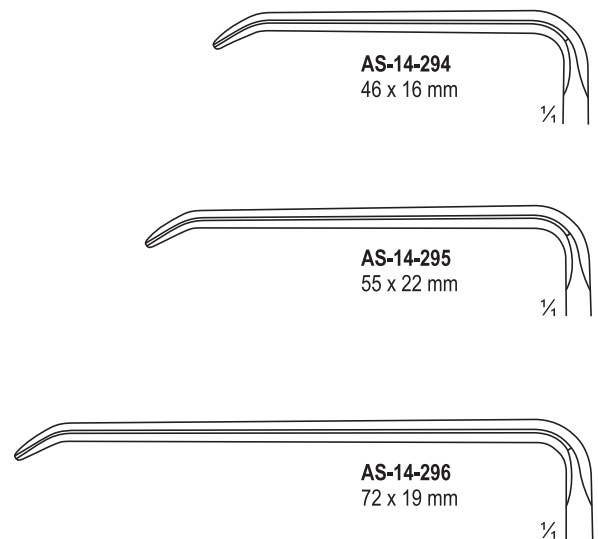



1/2
AS-14-297
15 x 15 mm
220 mm

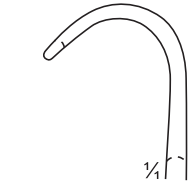

1/4



1/2
AS-14-298
20 x 22 mm
215 mm

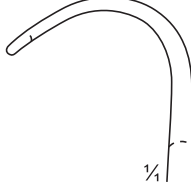

1/4



1/2
AS-14-299
28 x 28 mm
235 mm

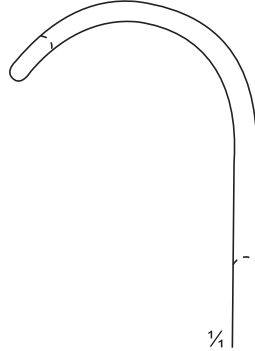

1/4

1/2
AS-14-297 -AS-14-299
MIDDELDORPF

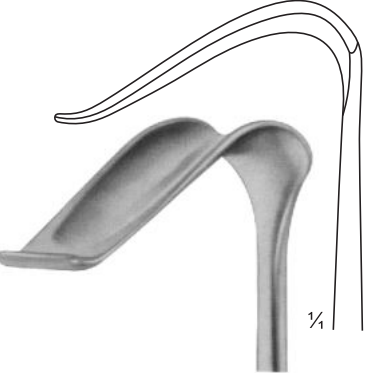

38 x 18 mm

AS-14-300
BUCHS 205
mm

1/2

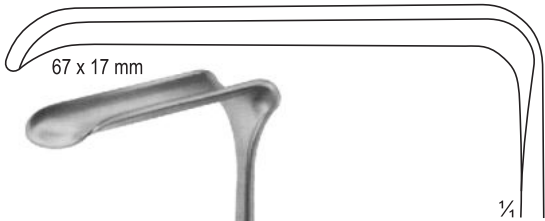

67 x 17 mm

1/4



AS-14-301
CASPAR
210 mm

1/2

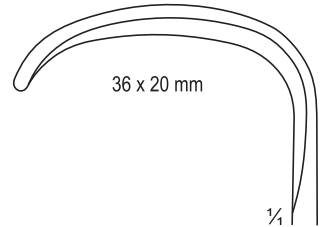

36 x 20 mm

1/4

AS-14-302
KOCHER
230 mm

1/2



1/2

AS-14-303 - AS-14-308
HOSEL
250 mm

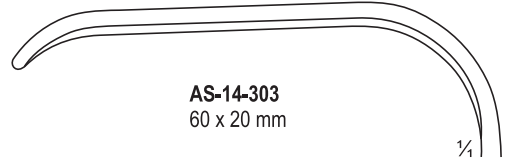

AS-14-303
60 x 20 mm

1/4

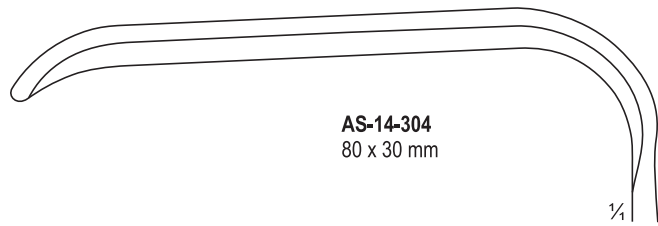

AS-14-304
80 x 30 mm

1/4

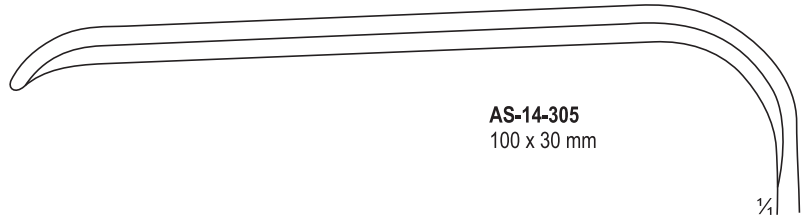

AS-14-305
100 x 30 mm

1/4

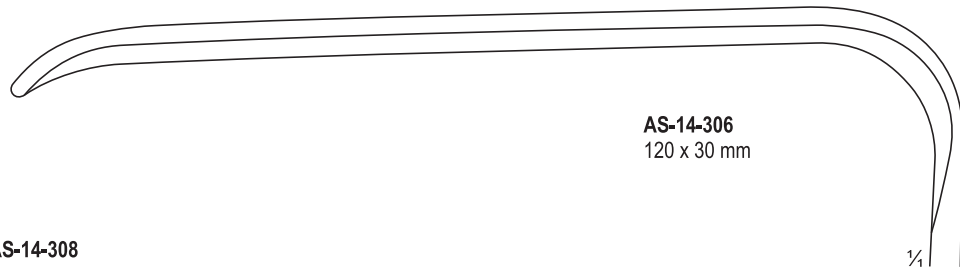

AS-14-306
120 x 30 mm

1/4

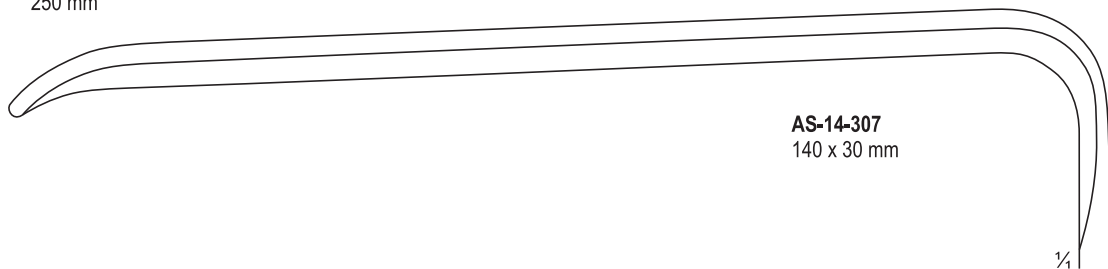

AS-14-307
140 x 30 mm

1/4

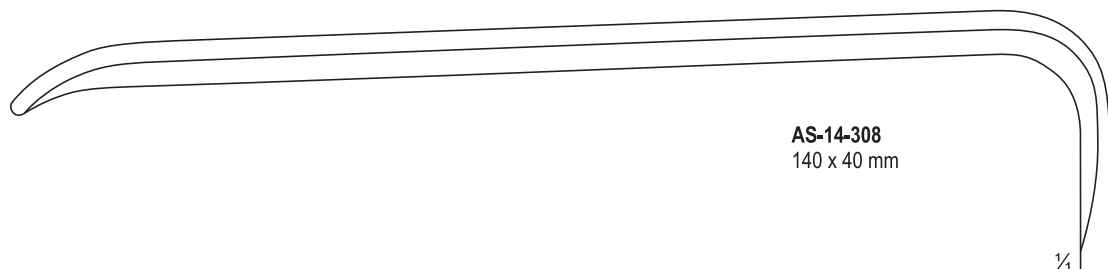

AS-14-308
140 x 40 mm

1/4

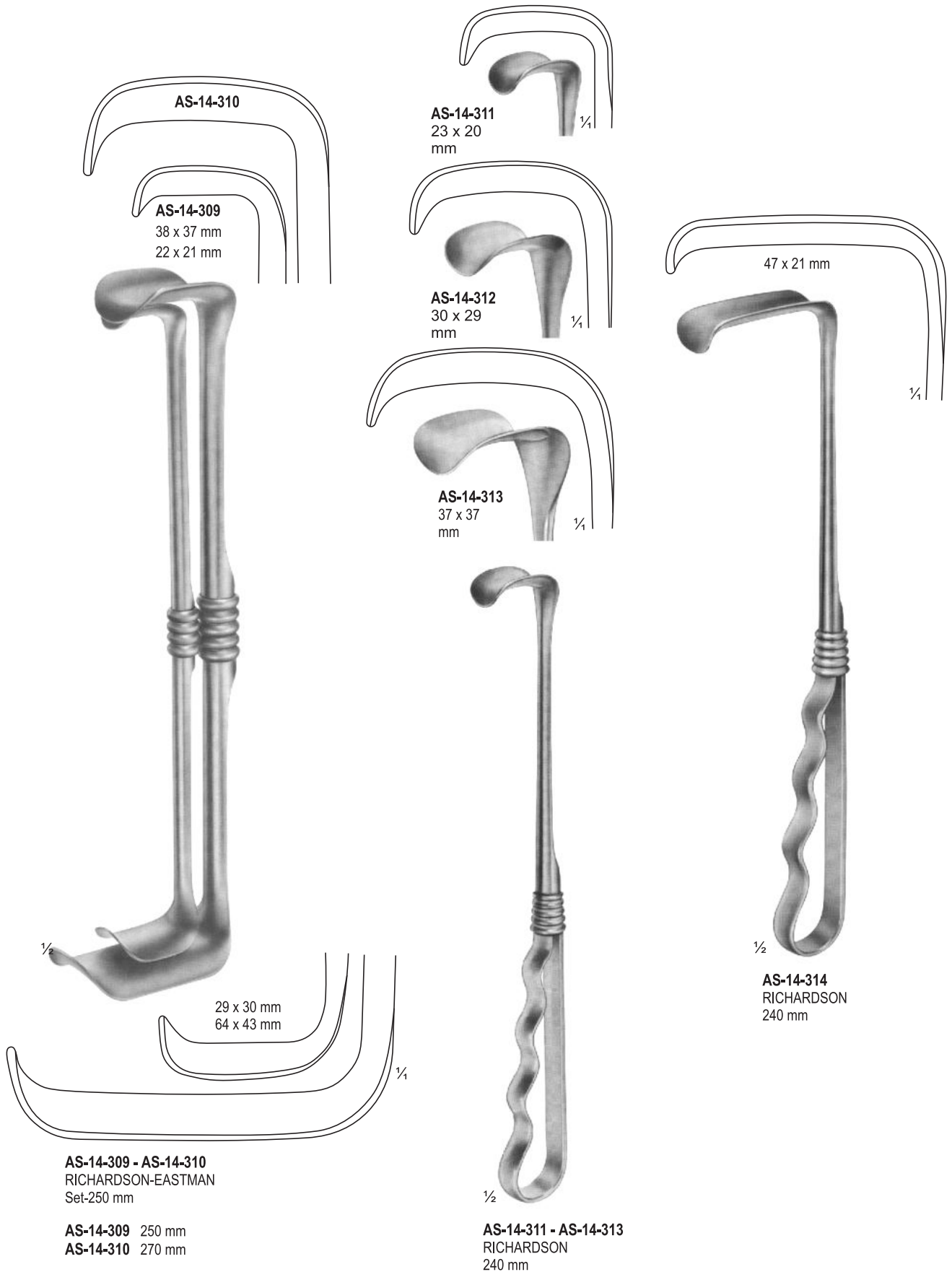

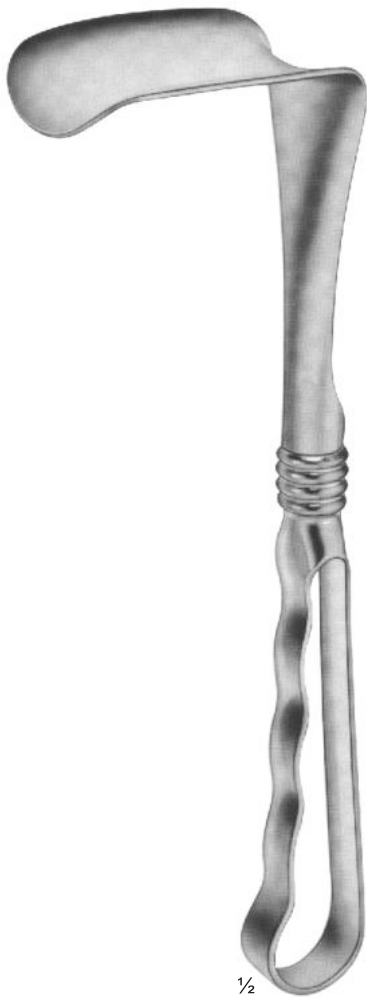
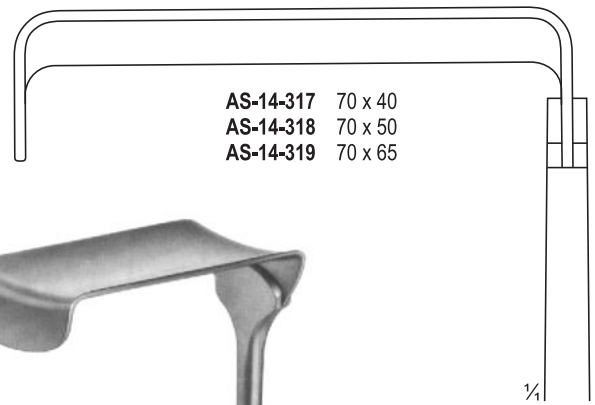
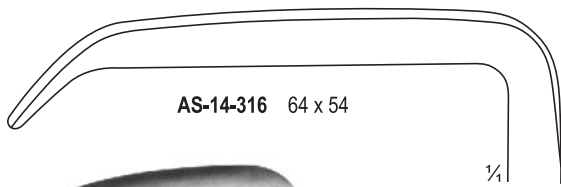
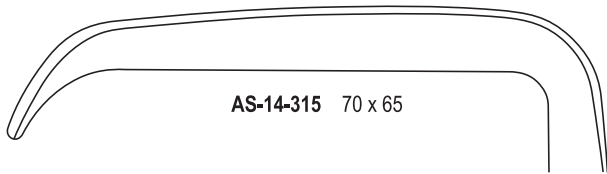

AS-14-315 - AS-14-316
KELLY
260 mm



AS-14-317 - AS-14-319
MORRIS
245 mm

RETRACTORS FOR DEEP SURGERY



ASAMAR
SURGICAL

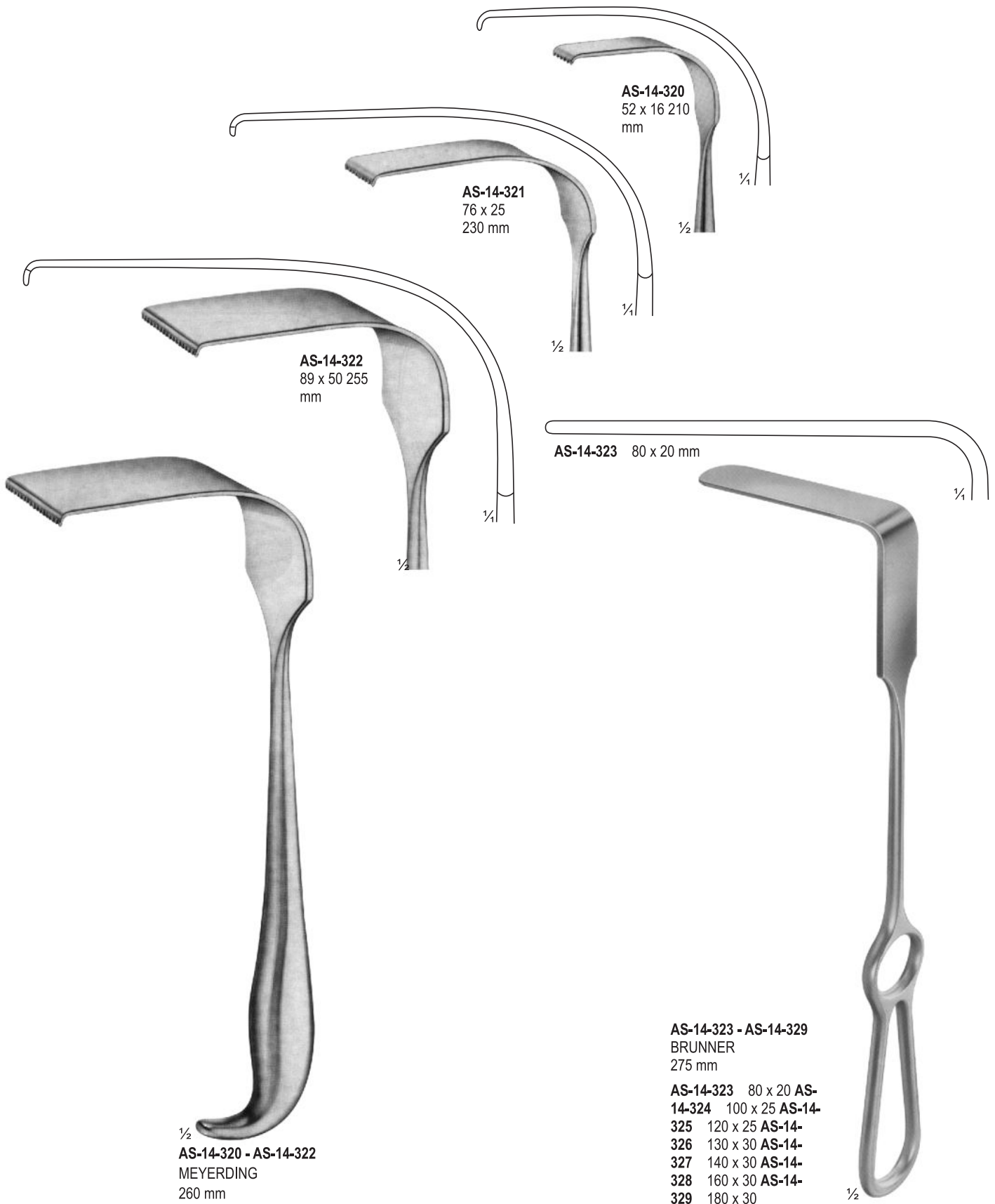

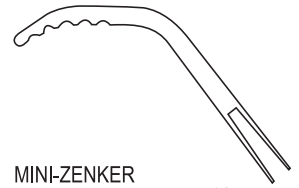

MINI-ZENKER
AS-14-330
180 mm
10 X 3 mm

1/4

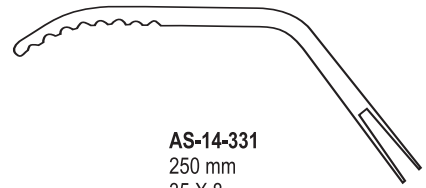

AS-14-331
250 mm
35 X 8 mm

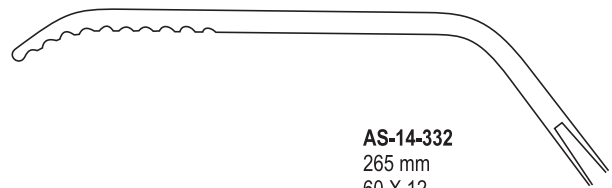

AS-14-332
265 mm
60 X 12 mm

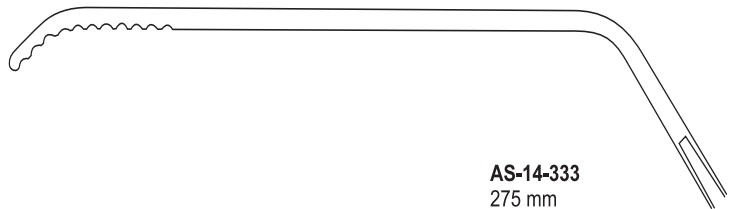

AS-14-333
275 mm
75 X 12 mm

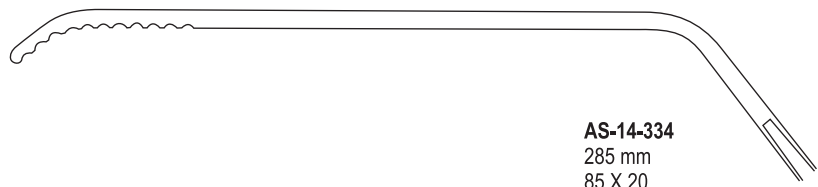

AS-14-334
285 mm
85 X 20 mm

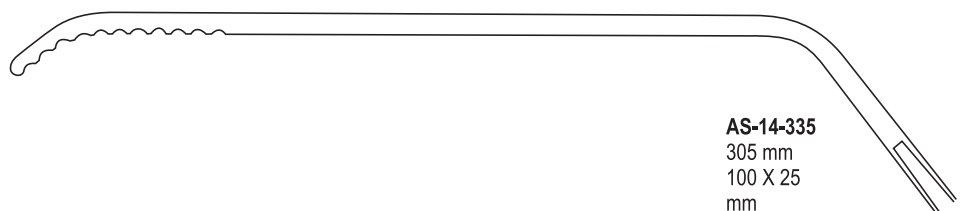

AS-14-335
305 mm
100 X 25 mm



1/2

ZENKER
AS-14-330 - AS-14-335



1/2

HOSEL
AS-14-336 - AS-14-341
250 mm

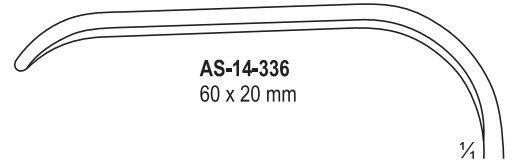

AS-14-336
60 x 20 mm

1/4

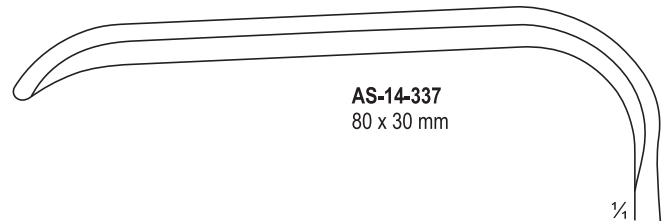

AS-14-337
80 x 30 mm

1/4

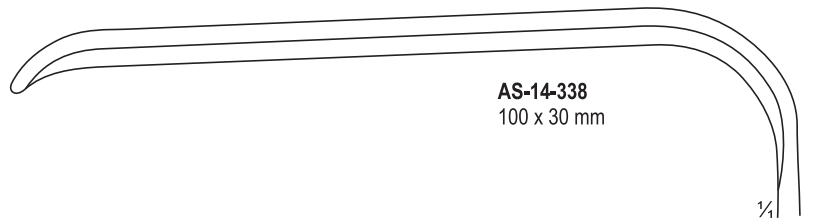

AS-14-338
100 x 30 mm

1/4

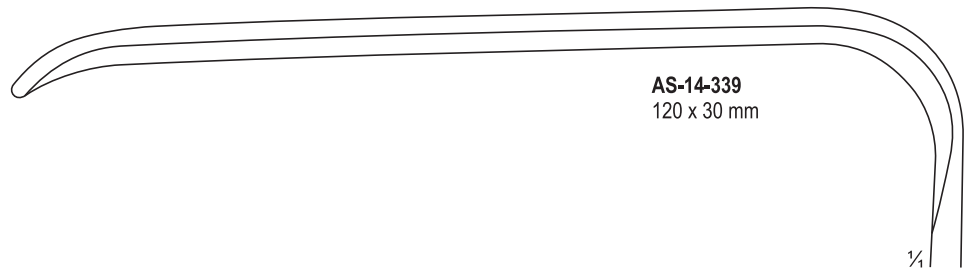

AS-14-339
120 x 30 mm

1/4

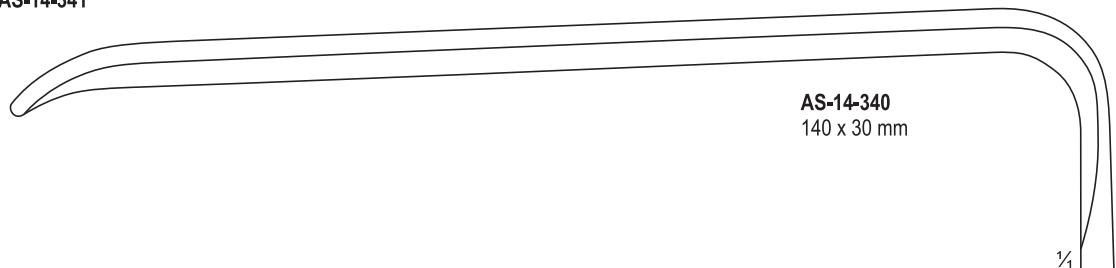

AS-14-340
140 x 30 mm

1/4

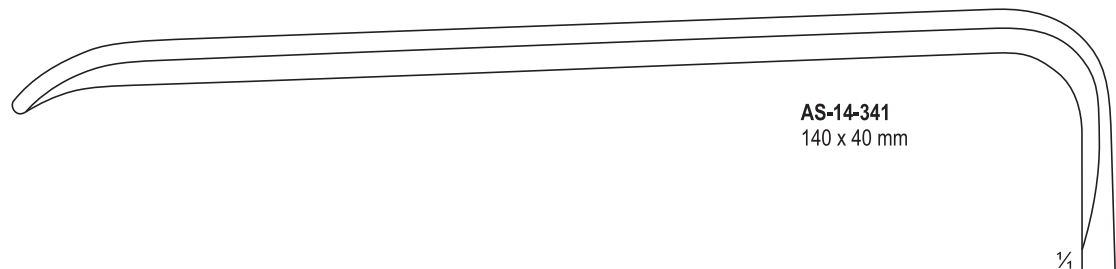

AS-14-341
140 x 40 mm

1/4



HÖSEL
AS-14-342 - AS-14-347
260 mm

½

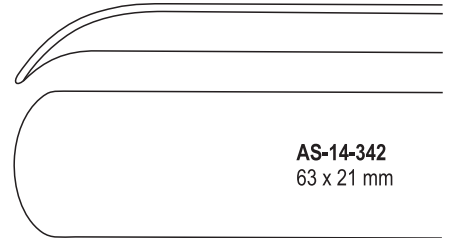

AS-14-342
63 x 21 mm

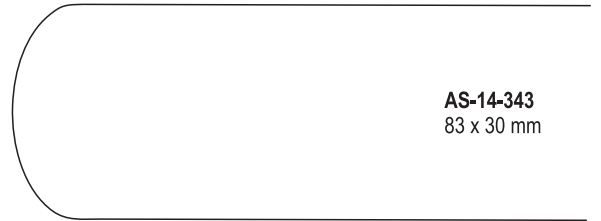

AS-14-343
83 x 30 mm

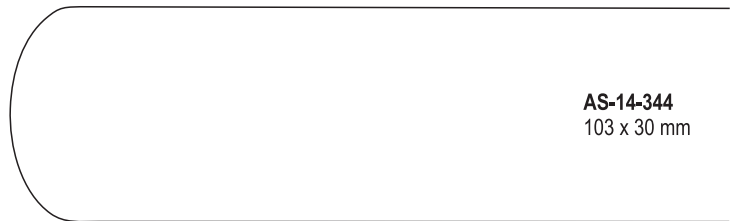

AS-14-344
103 x 30 mm

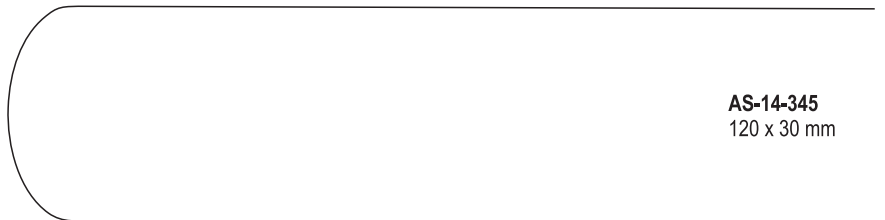

AS-14-345
120 x 30 mm

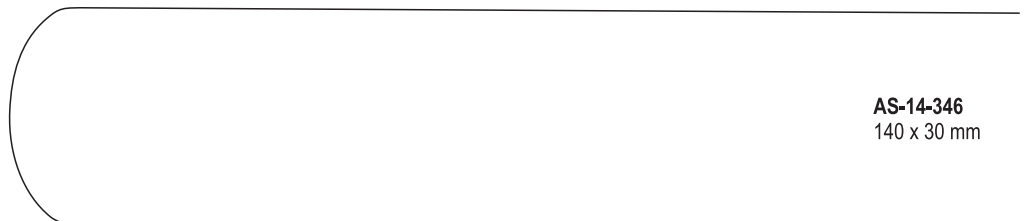

AS-14-346
140 x 30 mm

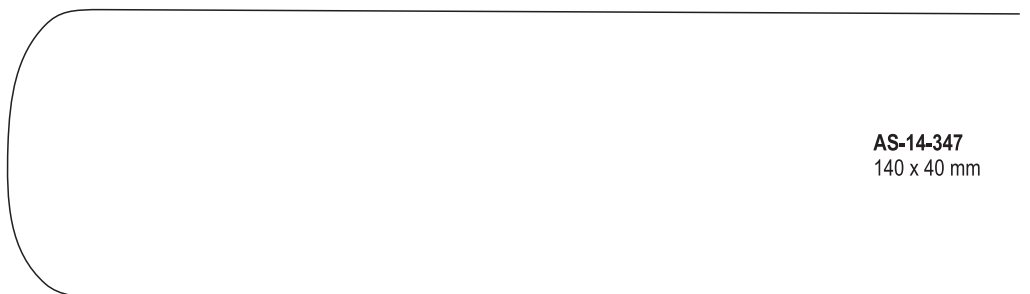

AS-14-347
140 x 40 mm

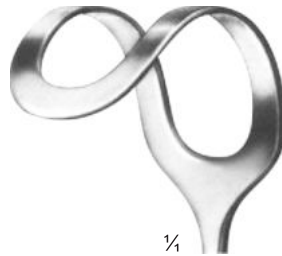

1/4

AS-14-348
270 mm
43 X 45
mm

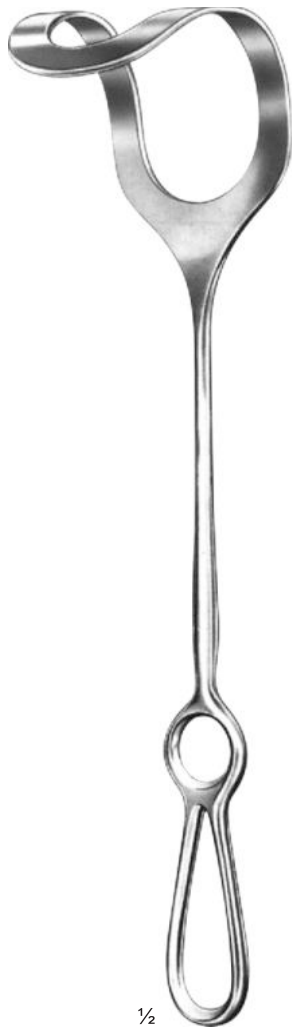
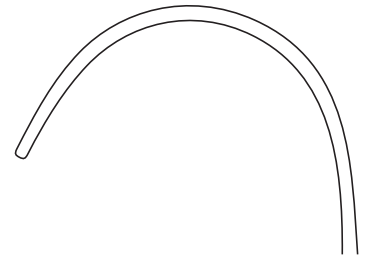

1/2

MIDDELDORPF
AS-14-348 - AS-14-350



AS-14-349
270 mm
52 X 50
mm

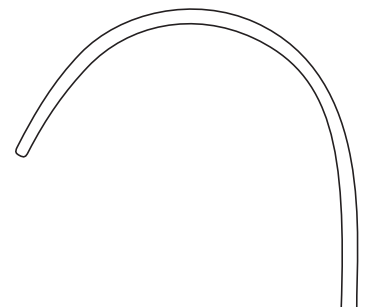

AS-14-350
280 mm
52 X 70
mm

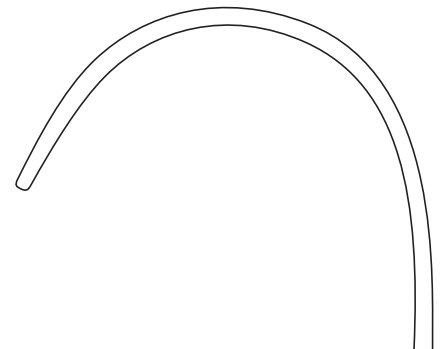

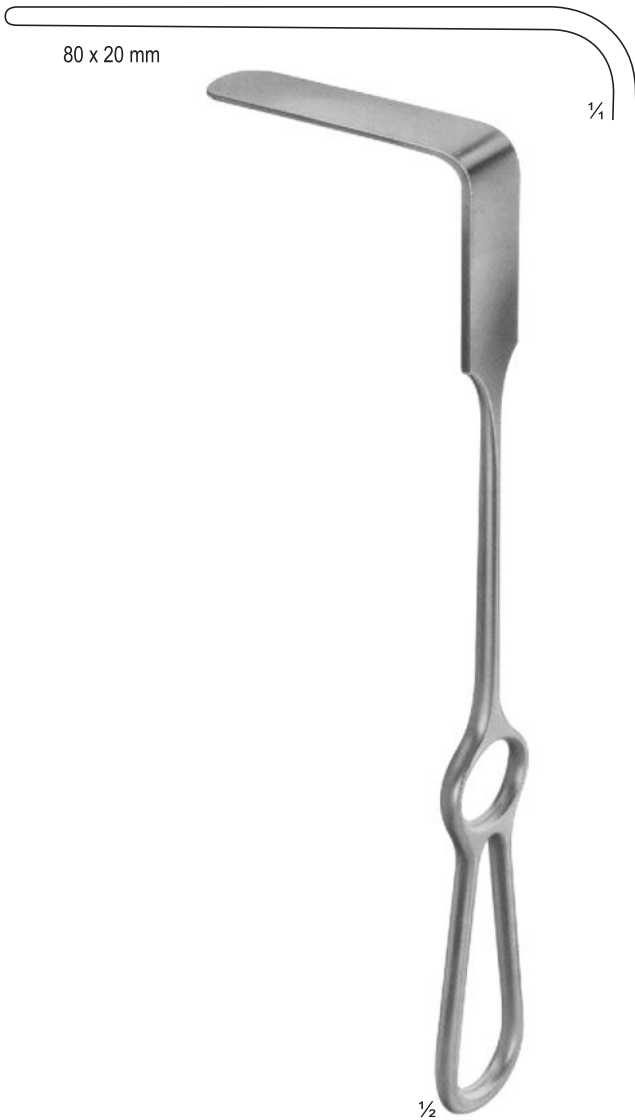

BRUNNER
AS-14-351 - AS-14-357
 275 mm

- AS-14-351** 80 x 20
- AS-14-352** 100 x 25
- AS-14-353** 120 x 25
- AS-14-354** 130 x 30
- AS-14-355** 140 x 30
- AS-14-356** 160 x 30
- AS-14-357** 180 x 30

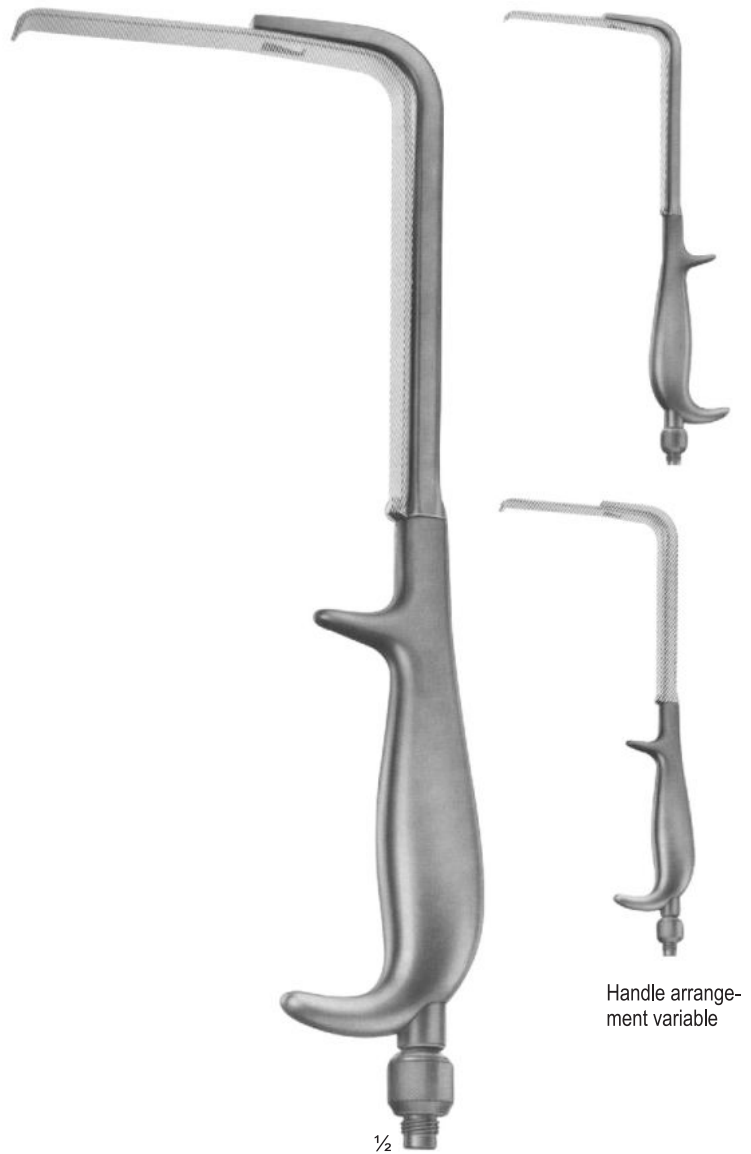

AS-14-358
 Handle with cold light carrier for retractor blades. 280 mm

Handle arrangement variable

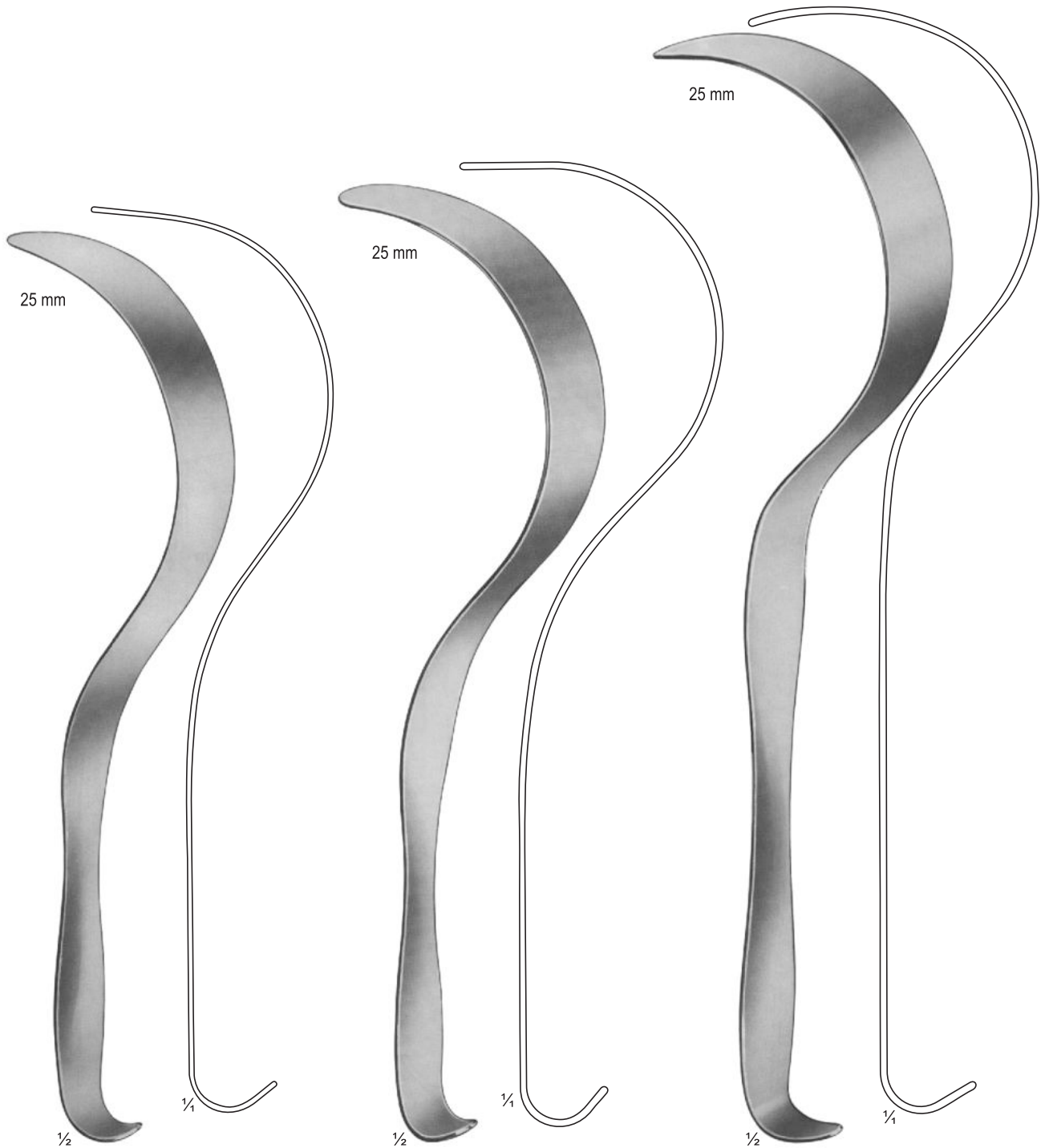

AS-14-359
DEAVER 300
mm Fig. 1

AS-14-360
DEAVER 315
mm Fig. 2

AS-14-361
DEAVER 365
mm Fig. 2



Fig. 3
DEAVER
AS-14-362
300 mm

Fig. 4
DEAVER
AS-14-363
310 mm

Fig. 5
DEAVER
AS-14-364
320 mm

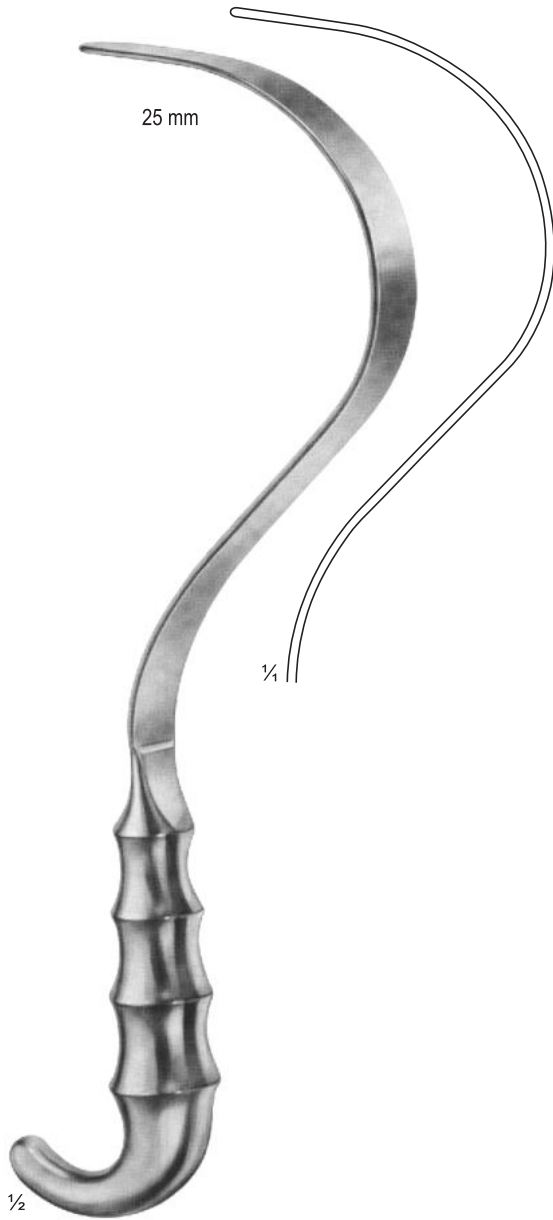

AS-14-365
DEAVER 310
mm Fig. 1

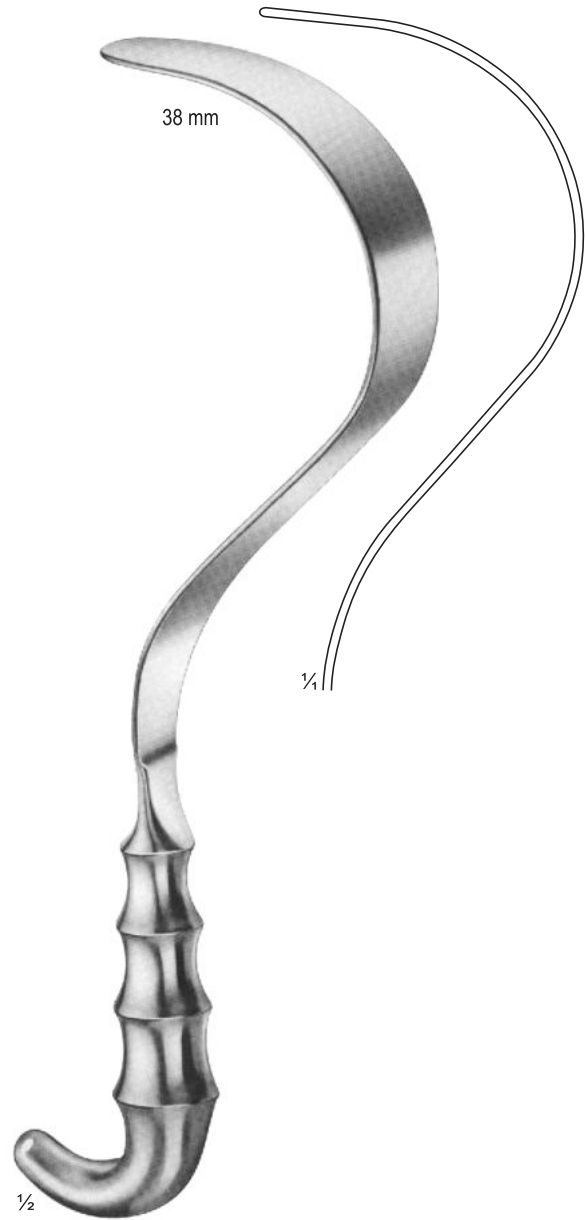

AS-14-366
DEAVER 310
mm Fig. 3



COOLEY
AS-14-367
250 mm
Right
48 X 48
mm



COOLEY **AS-14-368**
250 mm
Right, Serrated
48 X 48 mm



COOLEY
AS-14-369
275 mm
Left
30 X 48
mm

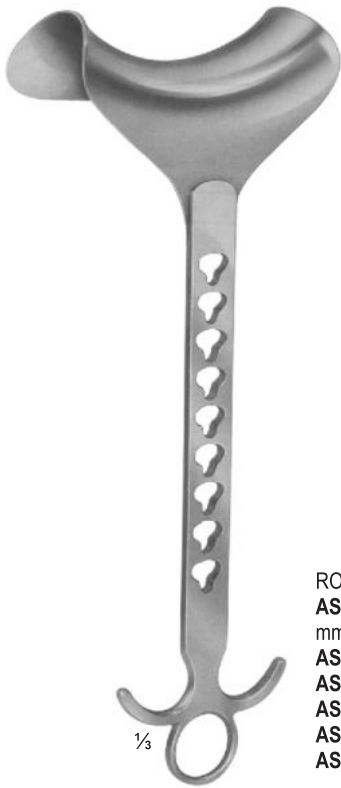

ROCHARD
AS-14-370 - AS-14-374 310 mm
AS-14-370 48 x 90 mm
AS-14-371 48 x 105 mm
AS-14-372 48 x 120 mm
AS-14-373 48 x 135 mm
AS-14-374 48 x 155 mm



AS-14-375



AS-14-376 - AS-14-379 280 mm
AS-14-376 48 x 90 mm **AS-14-377**
 48 x 105 mm **AS-14-378** 48 x 120
 mm **AS-14-379** 48 x 135 mm



DOYEN-CHILD
AS-14-380
 Fixation device
 220 mm



AS-14-381
 Chain with
 weight (747 / 645g)
 790 mm



SENN-GREEN
AS-14-382 - AS-14-383
160 mm



Fig. 1
AS-14-382
20 X 6 mm



Fig. 2
AS-14-383
10 X 6 mm



RAGNELL-DAVIS
AS-14-384
150 mm



$\frac{1}{4}$
8 X 4.5 mm

15 X 5.5 mm



CUSHING
AS-14-385
205 mm

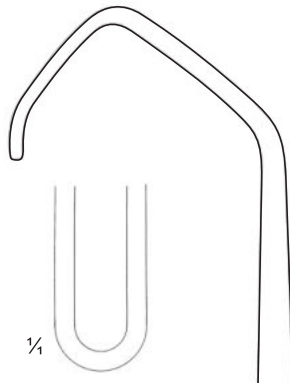

$\frac{1}{4}$

19 x 15 mm
19 x 15 mm



22 x 15 mm
22 x 15 mm
PARKER
AS-14-386
140 mm



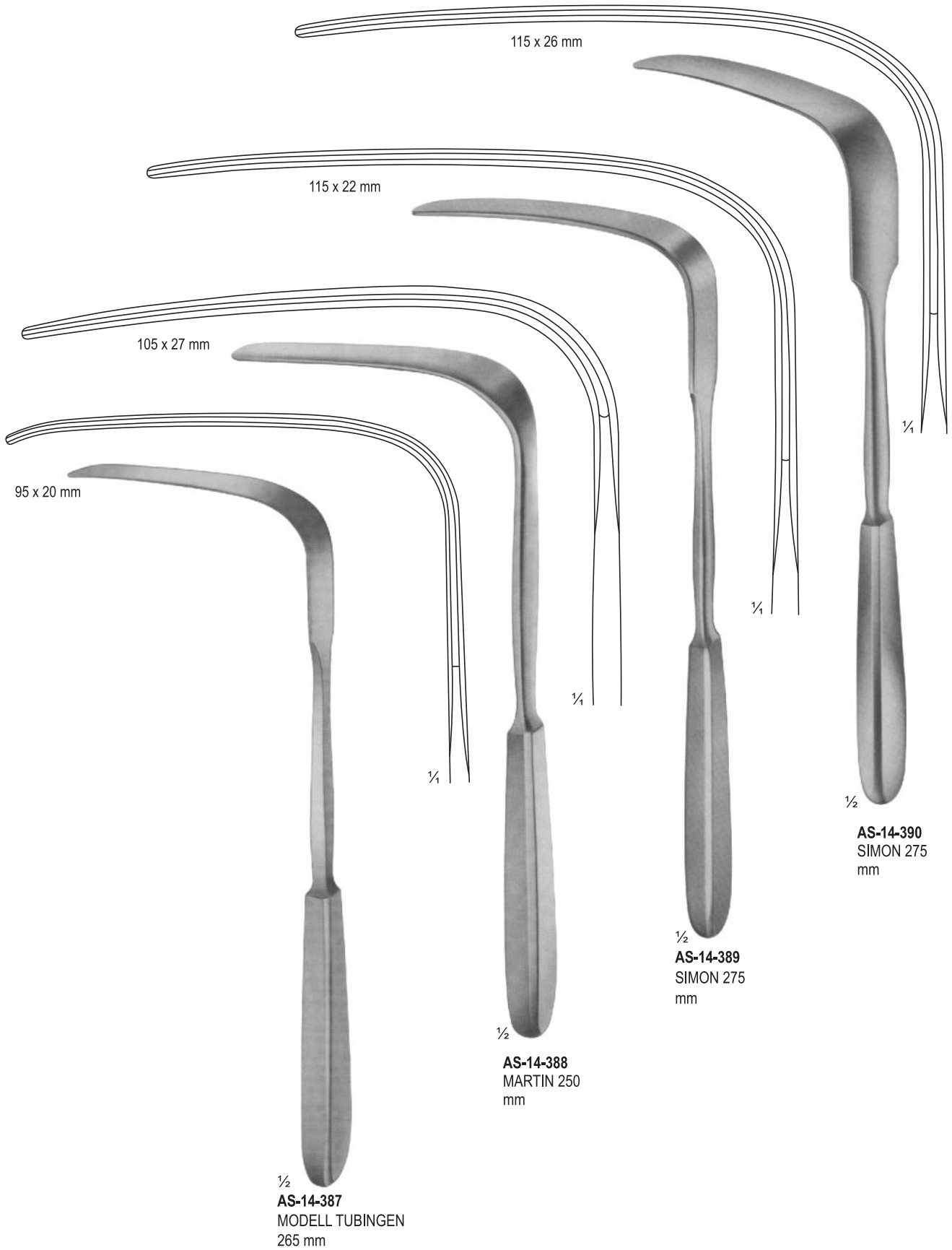

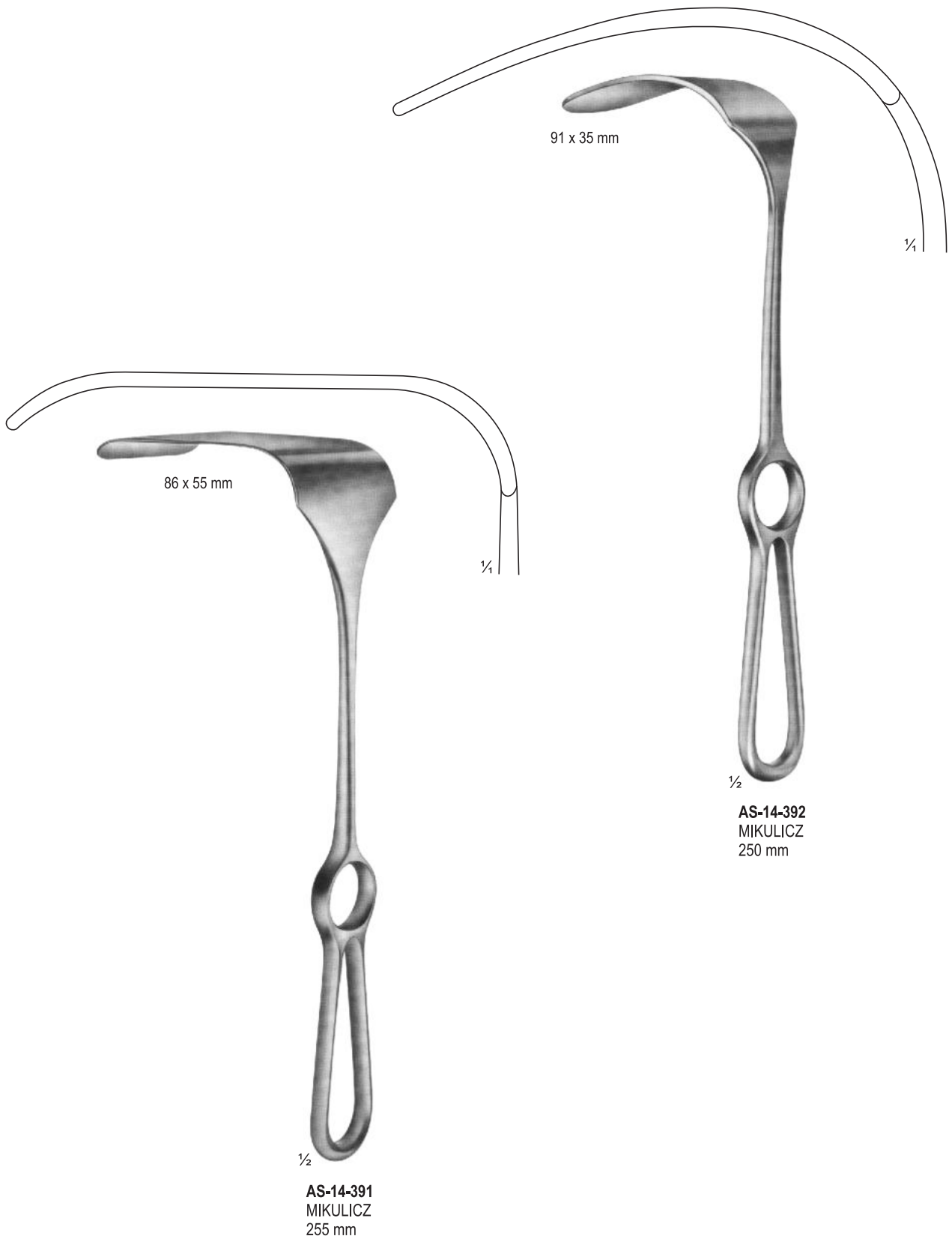

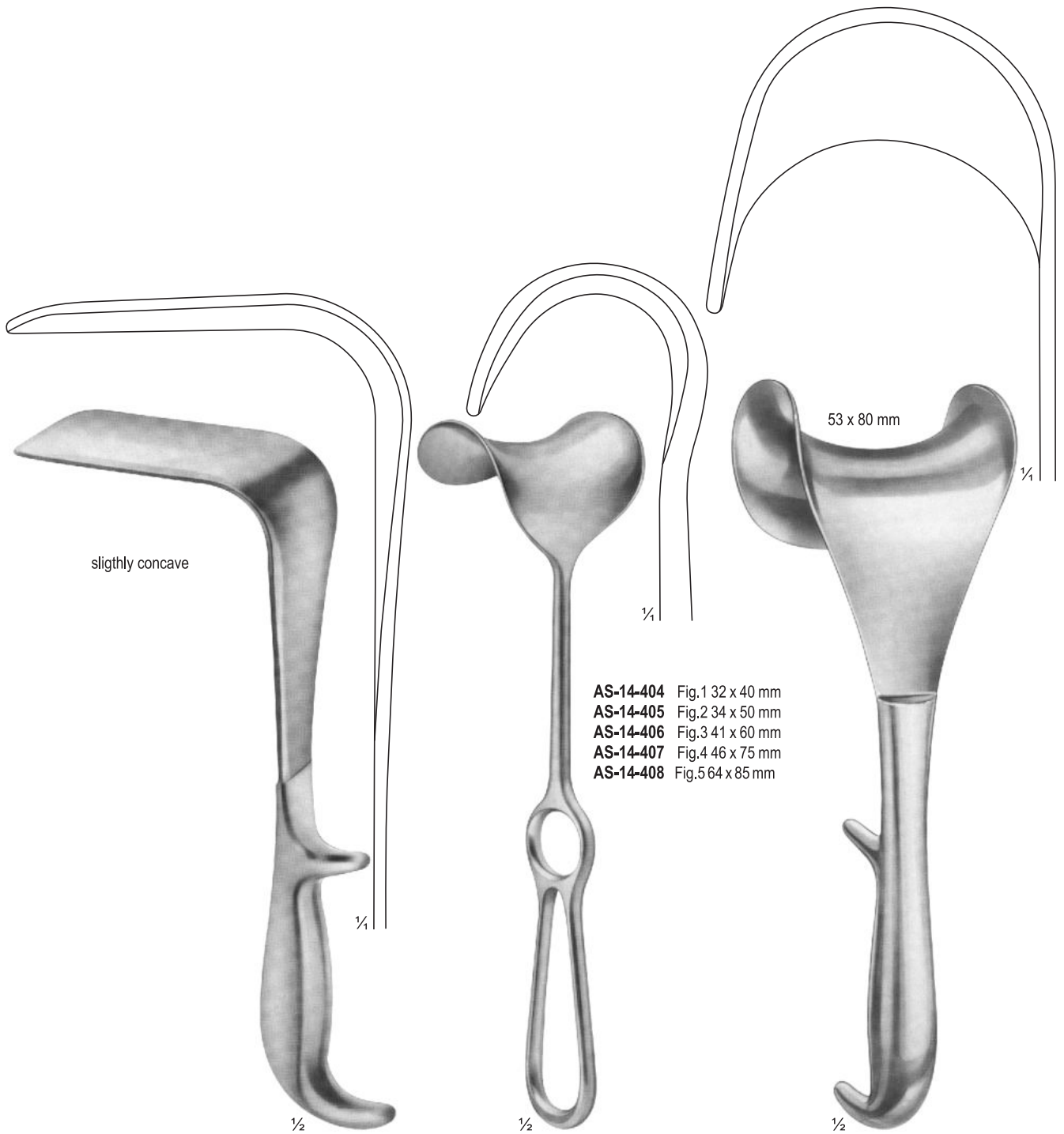

- AS-14-404 Fig.1 32 x 40 mm
- AS-14-405 Fig.2 34 x 50 mm
- AS-14-406 Fig.3 41 x 60 mm
- AS-14-407 Fig.4 46 x 75 mm
- AS-14-408 Fig.5 64 x 85 mm

AS-14-393 - AS-14-303
DOYEN
240 mm

AS-14-404 - AS-14-408
FRITSCH
240 mm

AS-14-409
DOYEN
250 mm

Width of Blades
35 mm, 45 mm, 60 mm

Length of Blades
62 mm
92 mm
122 mm
160 mm

AS-14-393, AS-14-397, AS-14-401
AS-14-394, AS-14-398, AS-14-402
AS-14-395, AS-14-399, AS-14-403
AS-14-396, AS-14-400

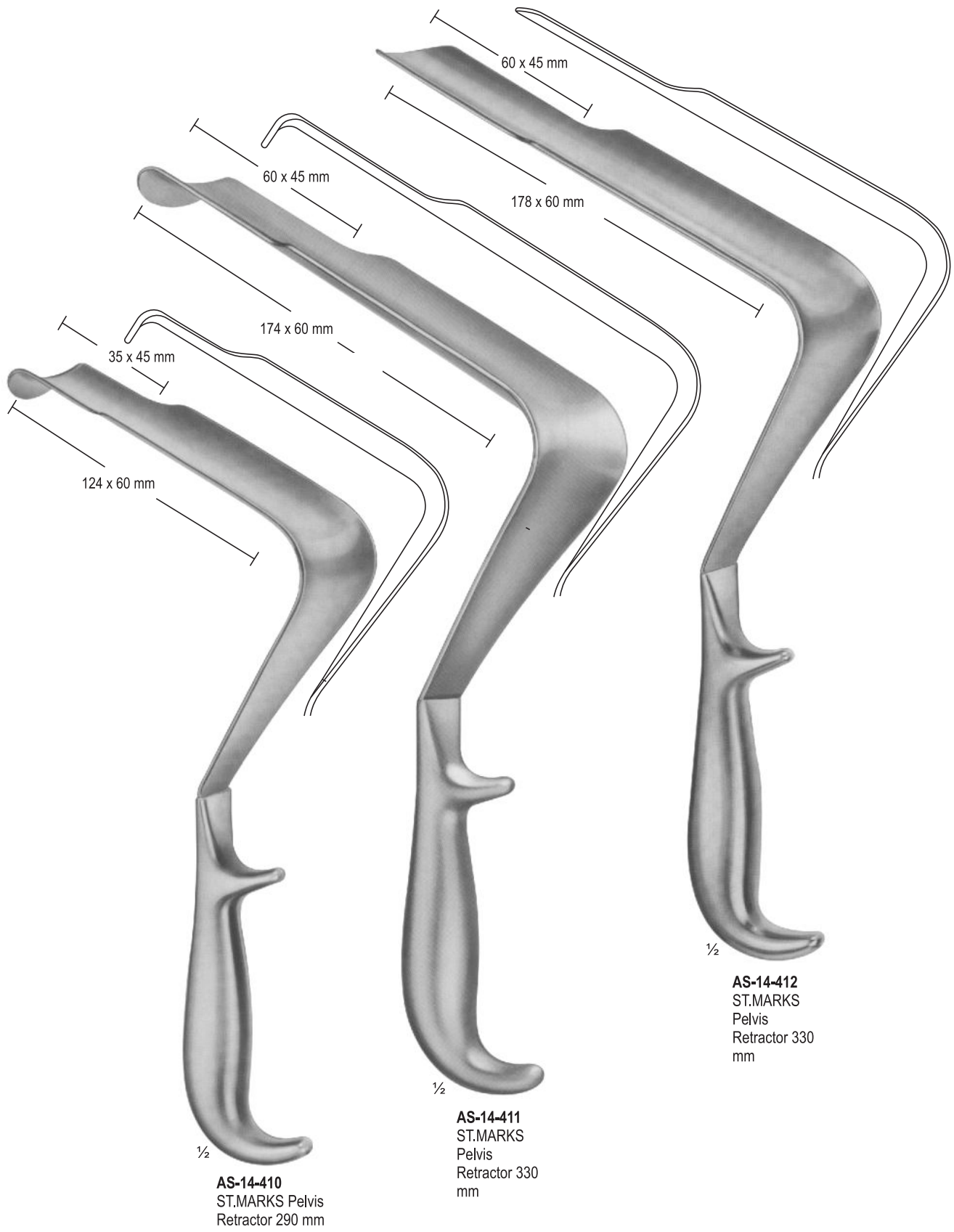



AS-14-413
LERICHE 255
mm

AS-14-414
KUMMEL
Malleable 285
mm

AS-14-415
MIKULICZ 29
mm
250 mm

AS-14-416 - AS-14-417
KADER
AS-14-416 30 mm
AS-14-417 40 mm
270 mm



AS-14-418
REVERDIN
285 mm



AS-14-419
HABERER
Malleable
305 mm



AS-14-420 - AS-14-422
AS-14-420 30 mm **AS-14-421** 40 mm **AS-14-422** 50 mm
Malleable
330 mm



AS-14-423
TUFFIER
Malleable
200 mm



ASAMAR
SURGICAL 

PAGE

289-311

**DILATORS
BIOPSY INSTRUMENTS
AND CURETTES
UTERINE PROBES,
UTERINE DRESSING
- TENACULUM
OVUM FORCEPS UTERINE
ELEVATING FORCEPS**



1/2

AS-15-101 - AS-15-143
HEGAR
with very conical point
185 mm

AS-15-101	1	mm	AS-15-123	23	mm
AS-15-102	2	mm	AS-15-124	24	mm
AS-15-103	3	mm	AS-15-125	25	mm
AS-15-104	4	mm	AS-15-126	26	mm
AS-15-105	5	mm	AS-15-127	1	1/2mm
AS-15-106	6	mm	AS-15-128	2	1/2mm
AS-15-107	7	mm	AS-15-129	3	1/2mm
AS-15-108	8	mm	AS-15-130	4	1/2mm
AS-15-109	9	mm	AS-15-131	5	1/2mm
AS-15-110	10	mm	AS-15-132	6	1/2mm
AS-15-111	11	mm	AS-15-133	7	1/2mm
AS-15-112	12	mm	AS-15-134	8	1/2mm
AS-15-113	13	mm	AS-15-135	9	1/2mm
AS-15-114	14	mm	AS-15-136	10	1/2mm
AS-15-115	15	mm	AS-15-137	11	1/2mm
AS-15-116	16	mm	AS-15-138	12	1/2mm
AS-15-117	17	mm	AS-15-139	13	1/2mm
AS-15-118	18	mm	AS-15-140	14	1/2mm
AS-15-119	19	mm	AS-15-141	15	1/2mm
AS-15-120	20	mm	AS-15-142	16	1/2mm
AS-15-121	21	mm	AS-15-143	17	1/2mm
AS-15-122	22	mm			



1/2

AS-15-144 - AS-15-152
HEGAR
205 mm

AS-15-144	1+2	mm
AS-15-145	3+4	mm
AS-15-146	5+6	mm
AS-15-147	7+8	mm
AS-15-148	9+10	mm
AS-15-149	11+12	mm
AS-15-150	13+14	mm
AS-15-151	15+16	mm
AS-15-152	17+18	mm

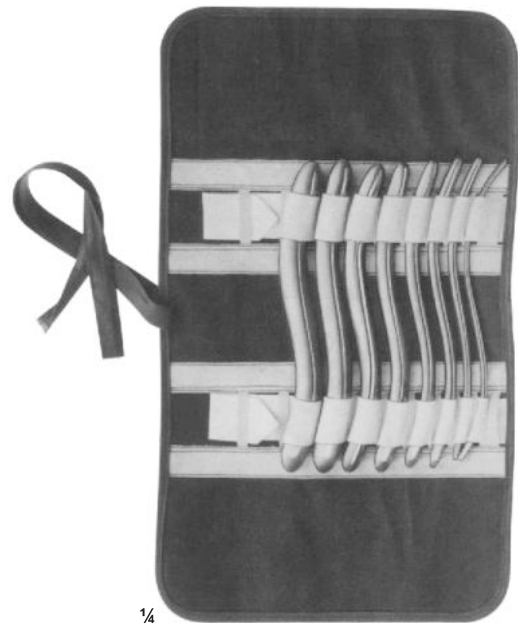

1/4

AS-15-153 HEGAR
Uterine dilator set, in canvas
roll with 8 dilators.



AS-15-154 HEGAR

Dilator set consisting of:

- 14 Dilators,
- 1 Rack for dilators (4 - 12 mm)
- 1 Rack for Dilators (13 - 17 mm)
- 1 Metal case only,
with hinged lid, stainless 200 X 100 X 35 mm

AS-15-155 HEGAR

Dilator set consisting of:

- 26 Dilators,
- 1 Rack for dilators (1 - 17 mm)
- 1 Rack for Dilators (18 - 26 mm)
- 1 Metal case only,
with hinged lid, aluminium 330 X 220 X 80 mm

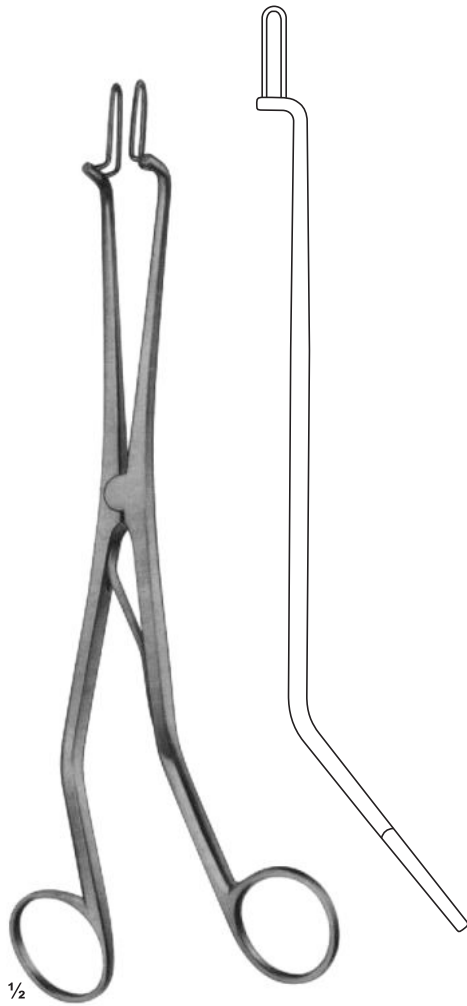

AS-15-156 KOGAN
Endospecula for cervix
and urethra, without ratchet
240 mm

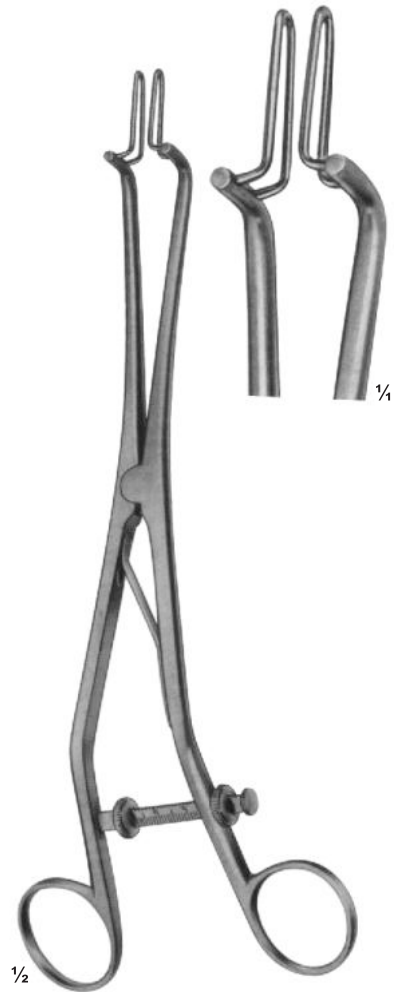

AS-15-157 KOGAN
Endospecula for cervix
and urethra, with
scale-ratchet and fixing
screws 240 mm



AS-15-158 MAYO
biegsam
malleable 330 mm



AS-15-159 SIMS
biegsam
malleable 330 mm

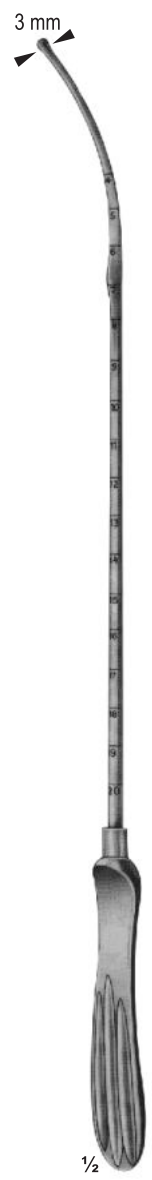

AS-15-160 MARTIN
330 mm



AS-15-161 SIMPSON
malleable
silver-plated
290 mm



AS-15-162 BRAUN
Uterine
depressor
270 mm



AS-15-163
Cotton
applicator
270 mm

UTERINE DRESSING FORCEPS



ASAMAR
SURGICAL

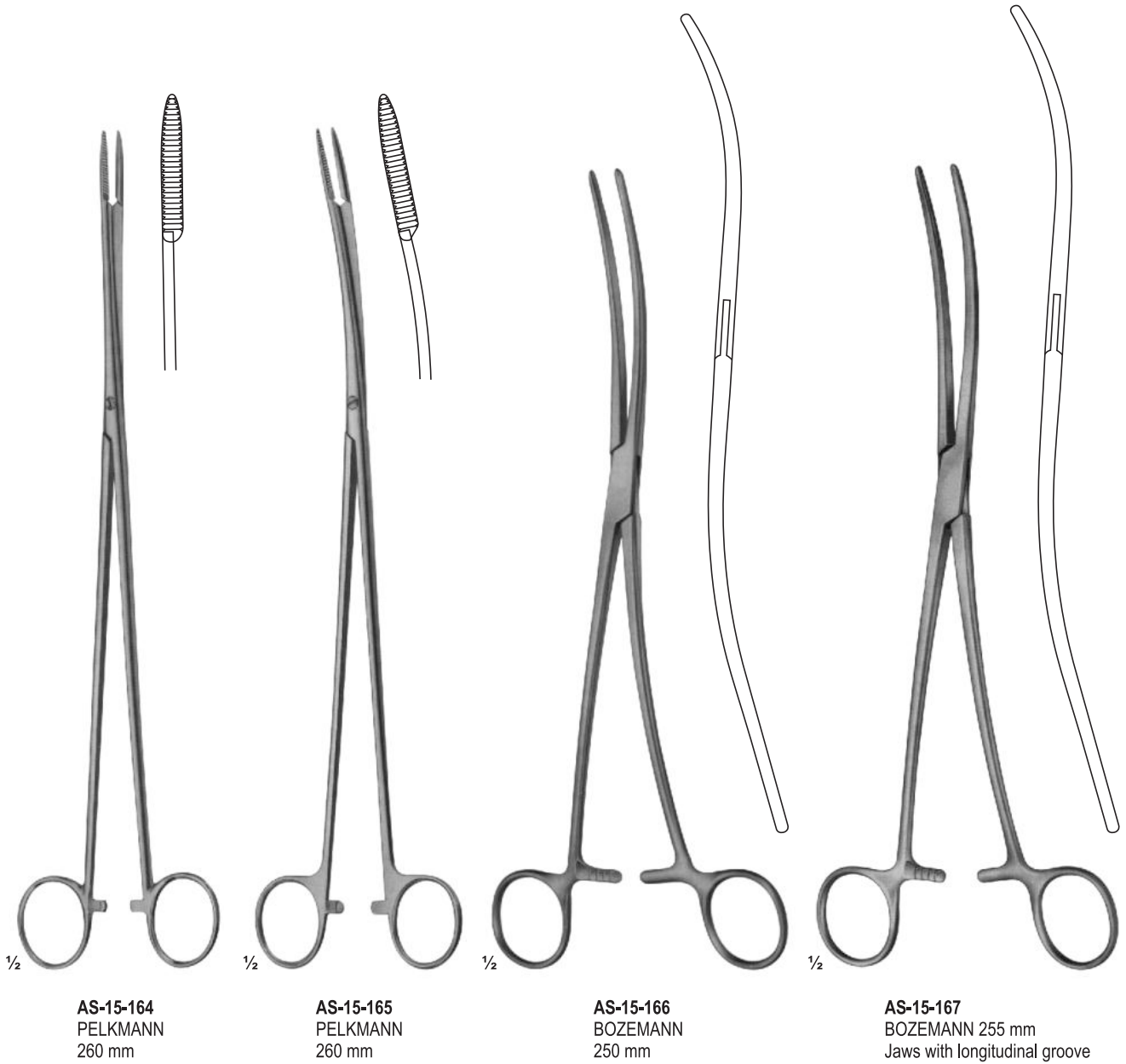

UTERINE DRESSING FORCEPS



ASAMAR
SURGICAL 

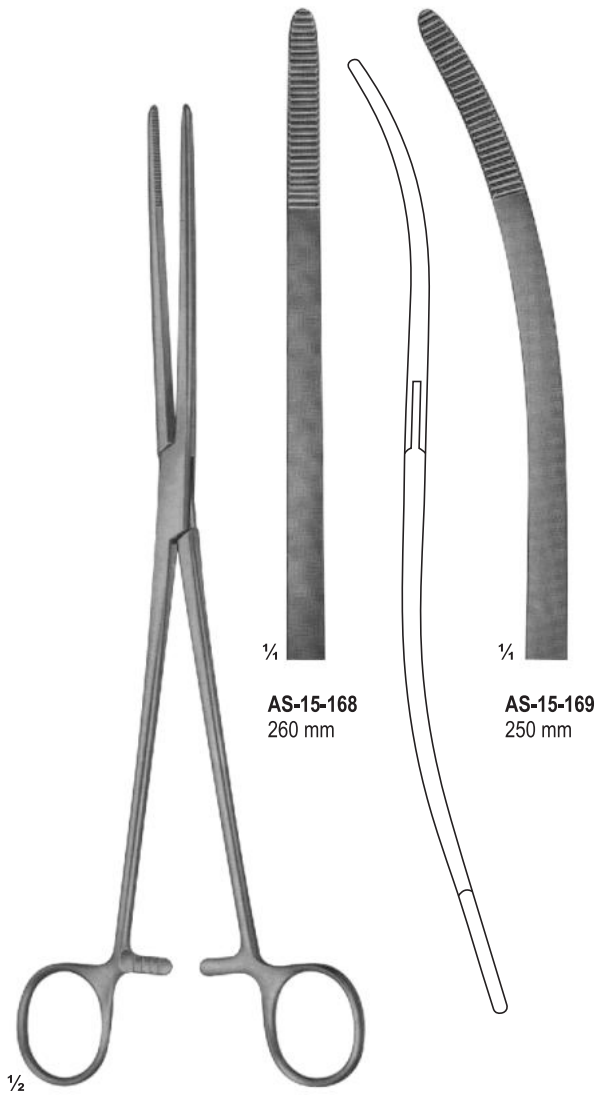

AS-15-168
260 mm

AS-15-169
250 mm

AS-15-168 - AS-15-169
BOZEMANN



AS-15-170
BOZEMANN-DOUGLAS
260 mm

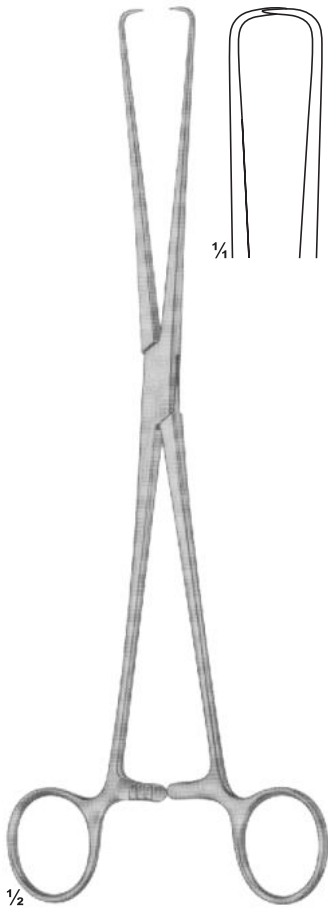

AS-15-171
BRAUN
slender
type 250
mm



AS-15-172
SCHRODER
250 mm



AS-15-173
POZZI
heavy
type 255
mm

UTERINE TENACULUM FORCEPS

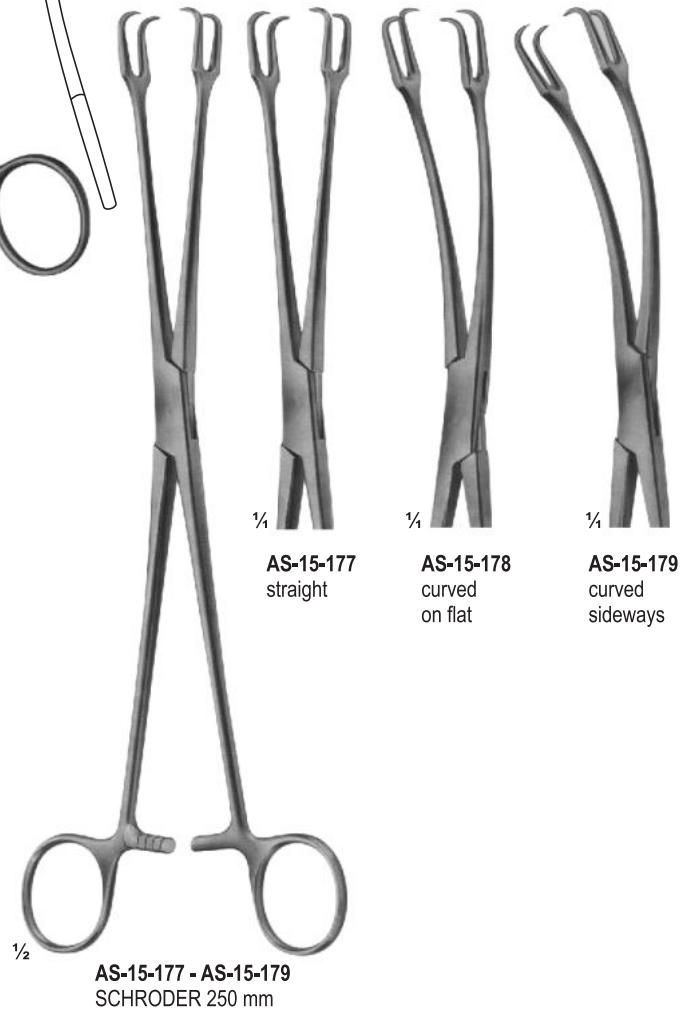
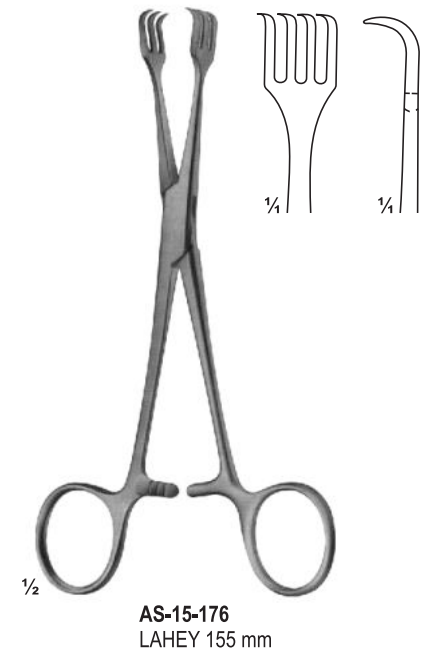
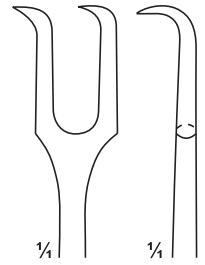
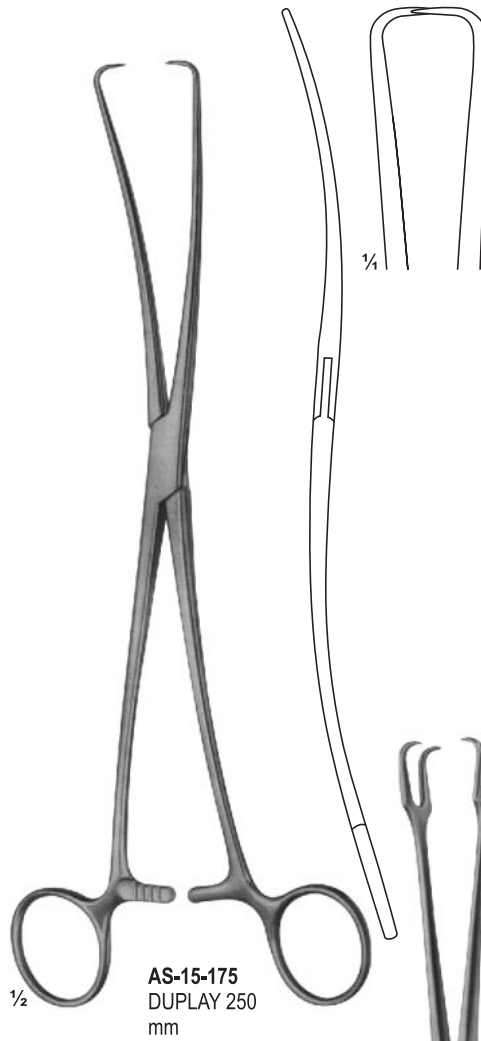
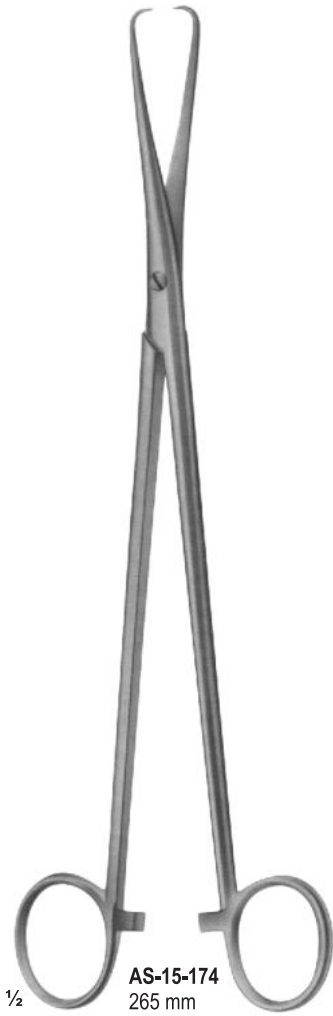

UTERINE TENACULUM FORCEPS

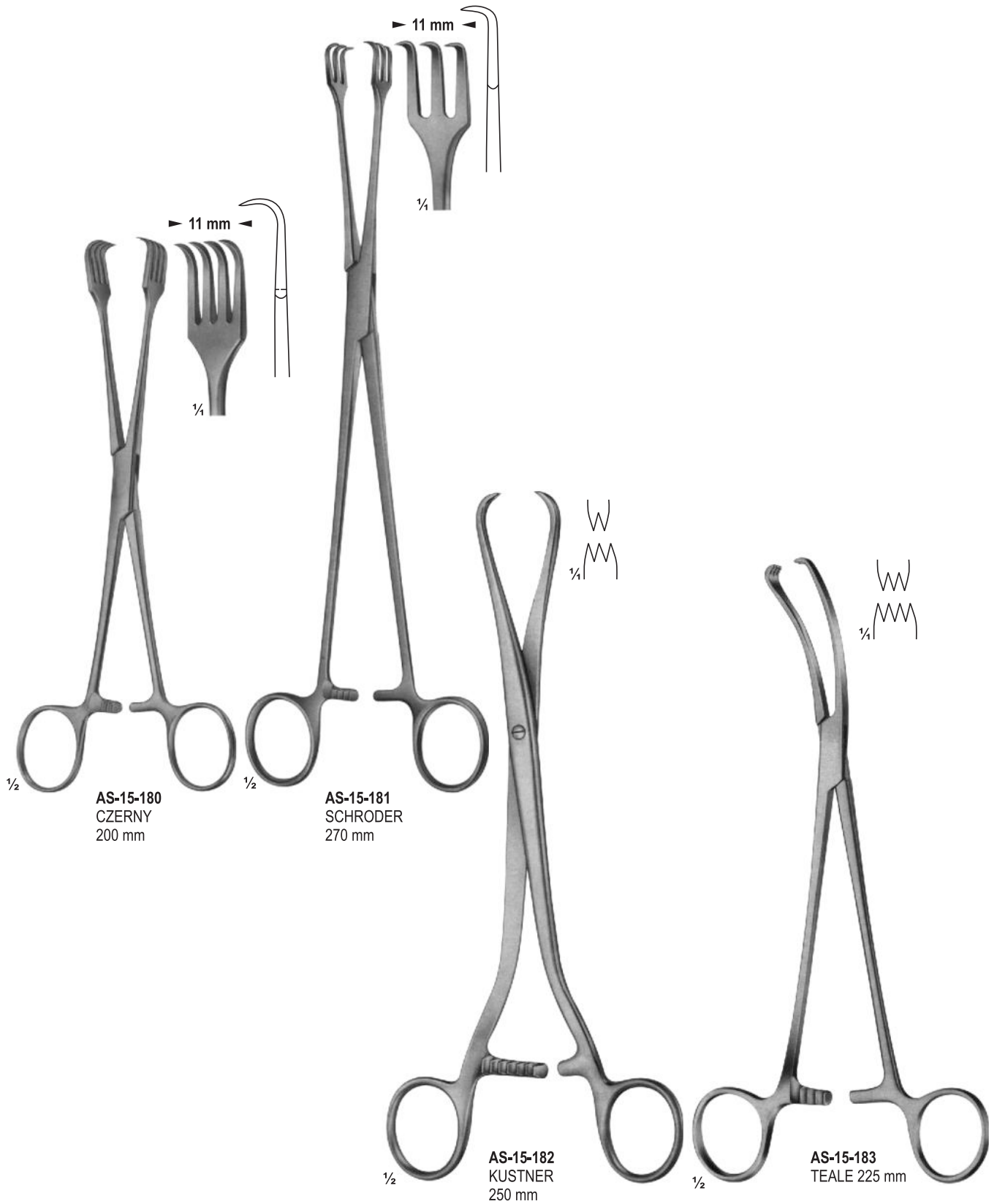

UTERINE ELEVATING FORCEPS



ASAMAR
SURGICAL 

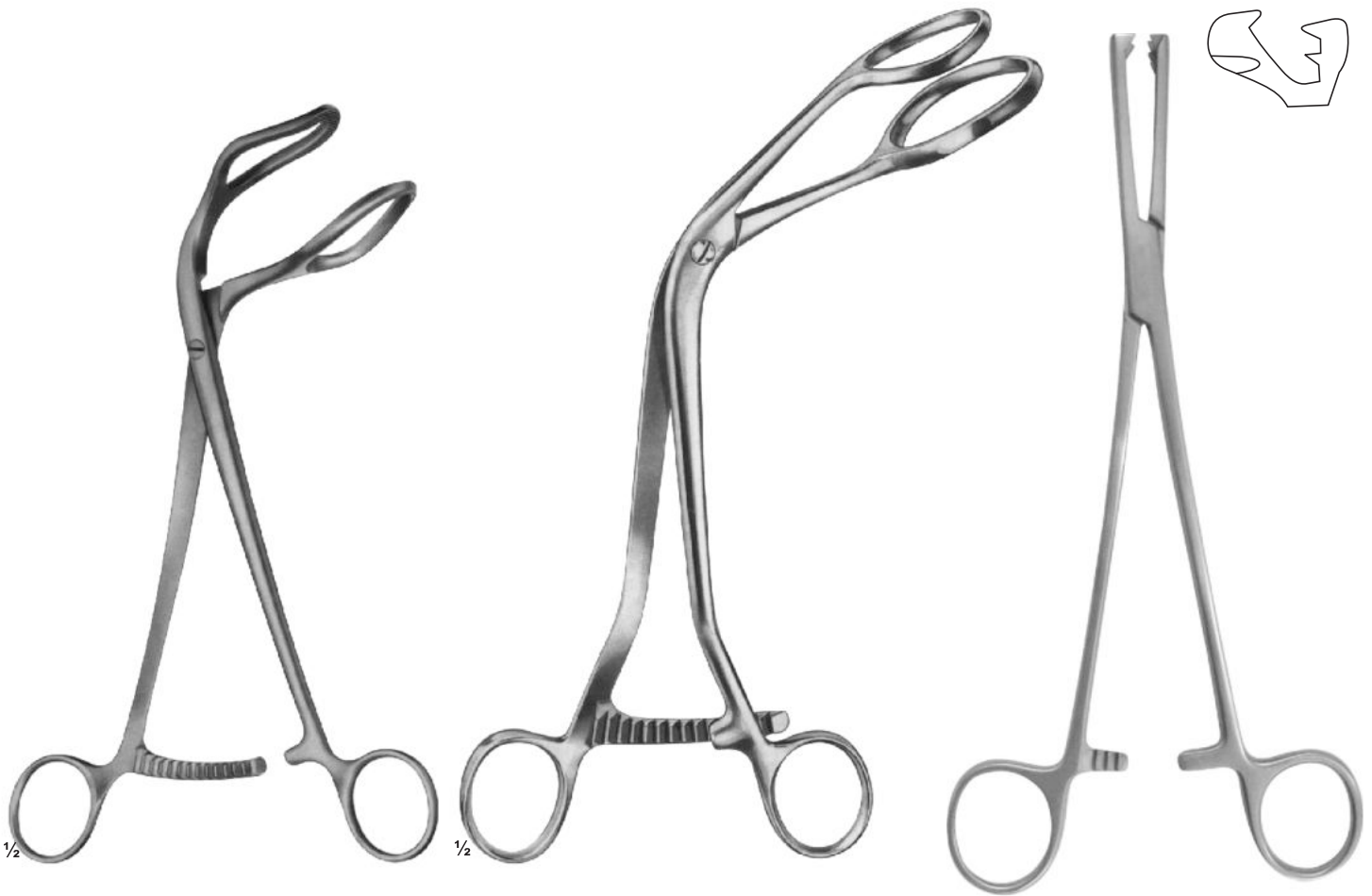

AS-15-184
SOMER 235 mm

AS-15-185
STRASSMANN 260 mm

AS-15-186
JACOBS 8.5 mm

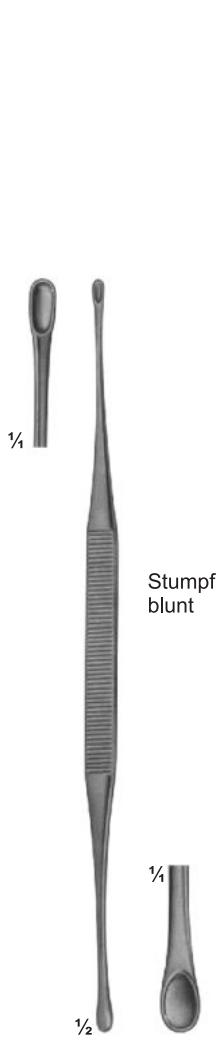

AS-15-187
ASCH
Uterine
Secretion scoop
200 mm

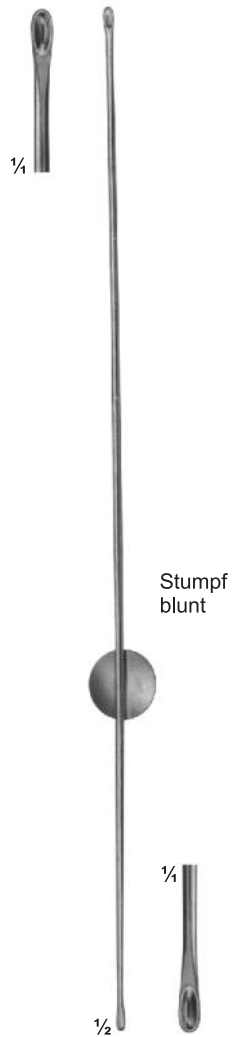

AS-15-188
Uterine
Secretion scoop
270 mm



AS-15-189 NOVAK-
SCHOECKAERT
Endometrial biopsy
curette
240 mm



AS-15-190
RANDALL
Endometrial biopsy
curette
240 mm

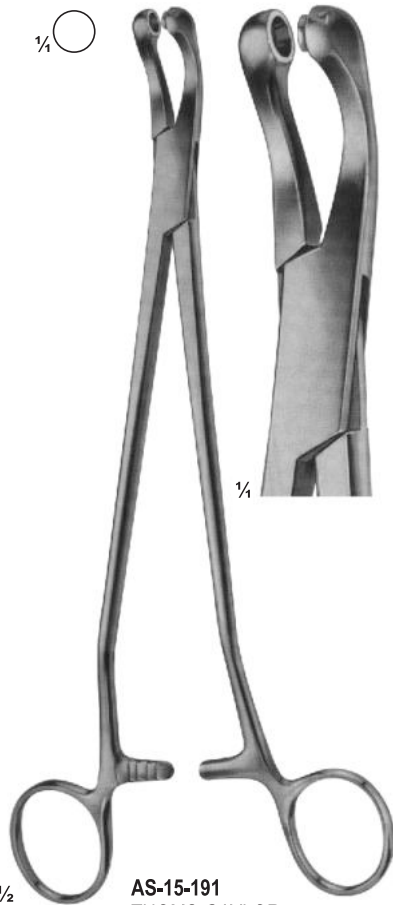

1/2

AS-15-192
SCHUBERT
260 mm

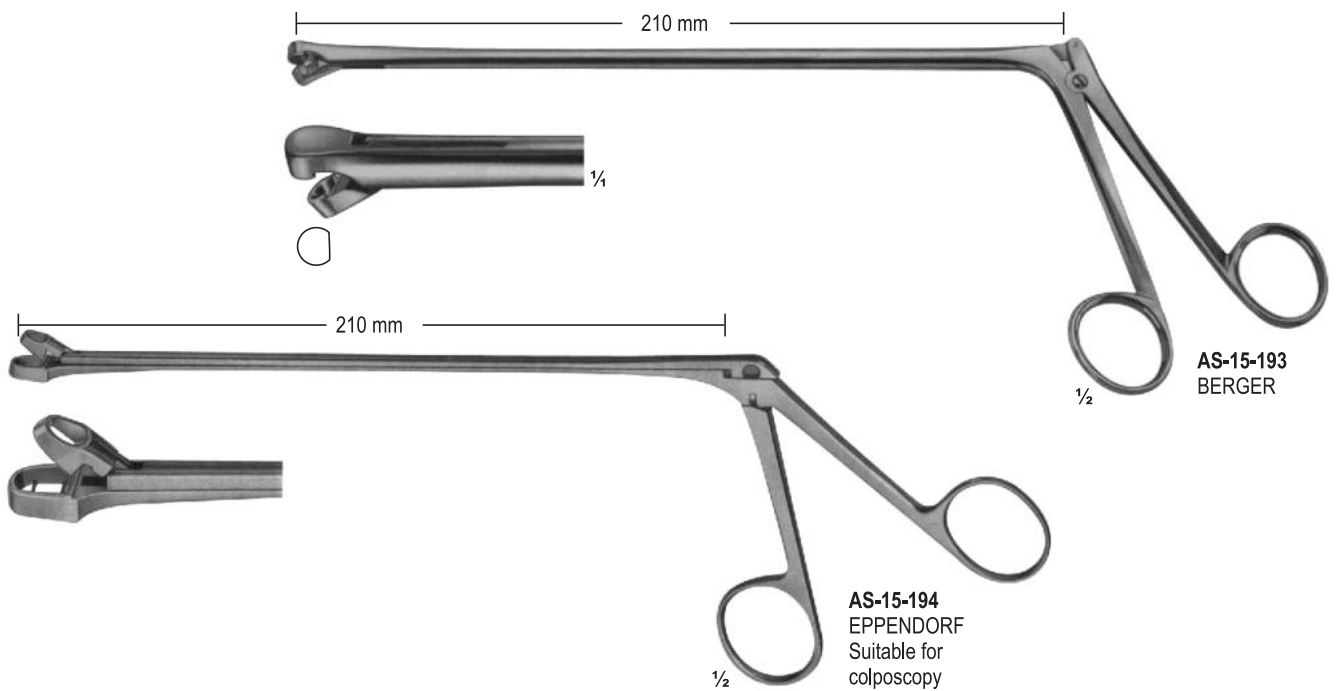

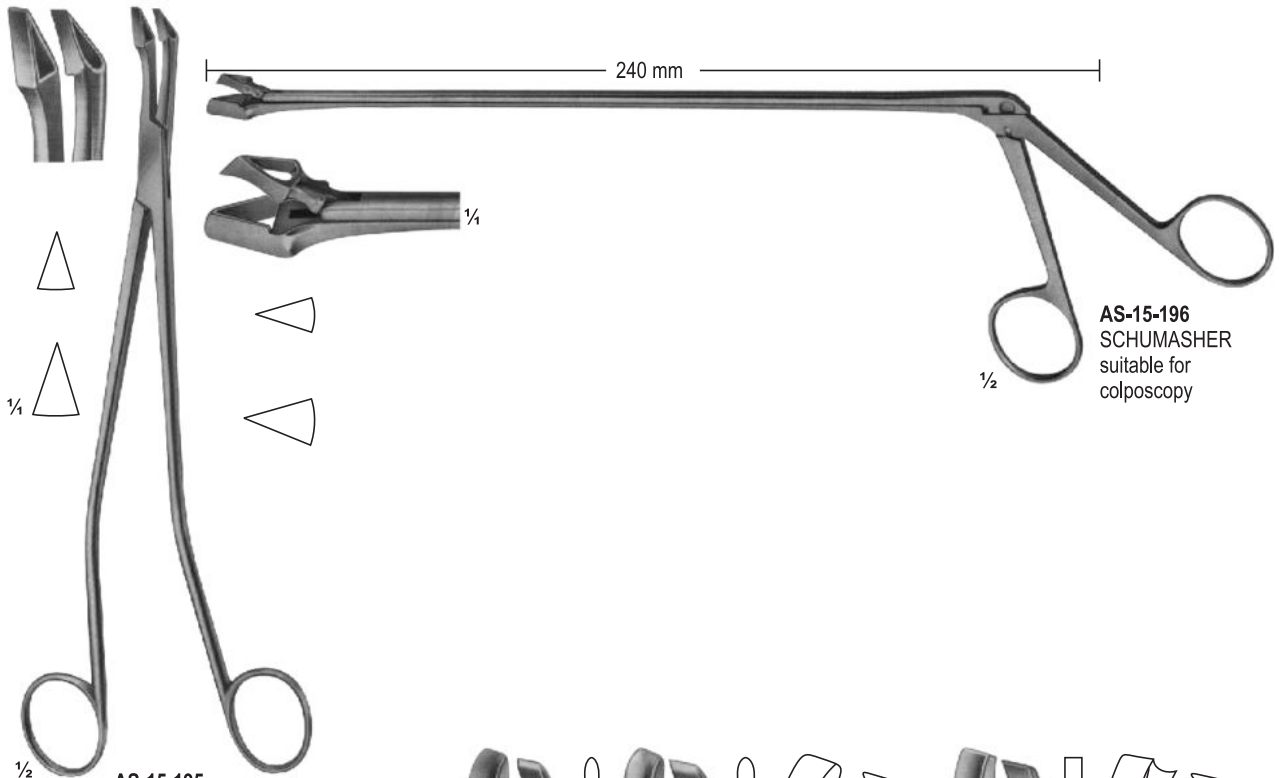

AS-15-195
SCHUMASHER
240 mm

AS-15-196
SCHUMASHER
suitable for
colposcopy

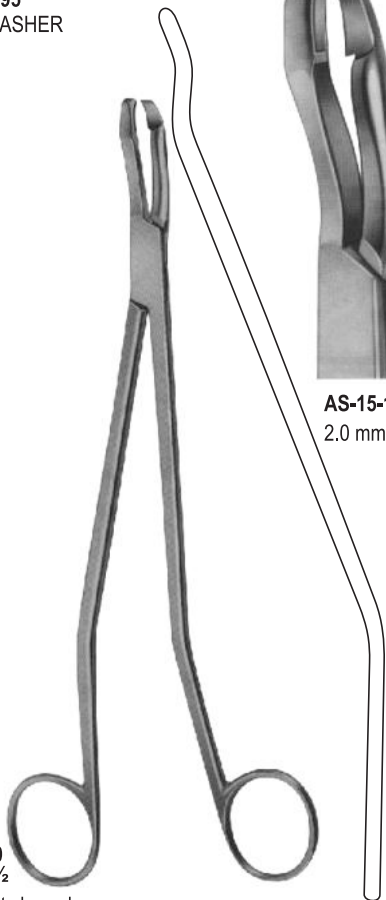

AS-15-197 - AS-15-199
SEIDL DBP
Biopsy forceps, bayonet shaped
for portio, vagina and vulva
240 mm

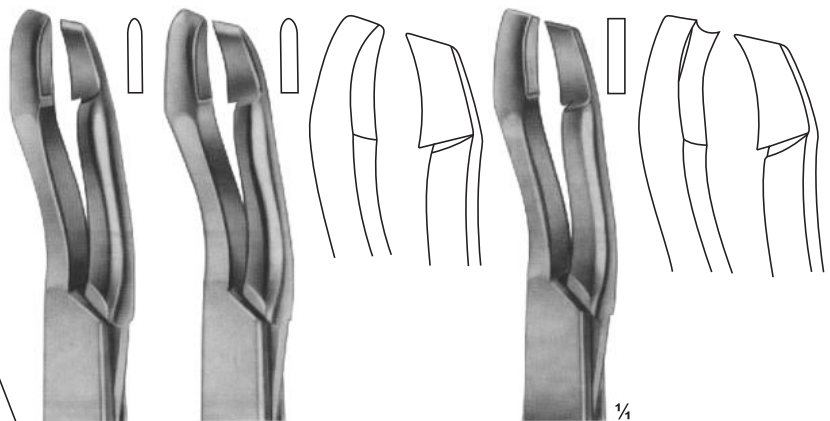

AS-15-197
2.0 mm

AS-15-198
2.4 mm

AS-15-199
2.4 mm

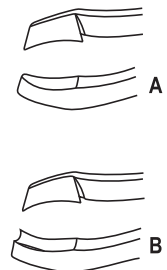

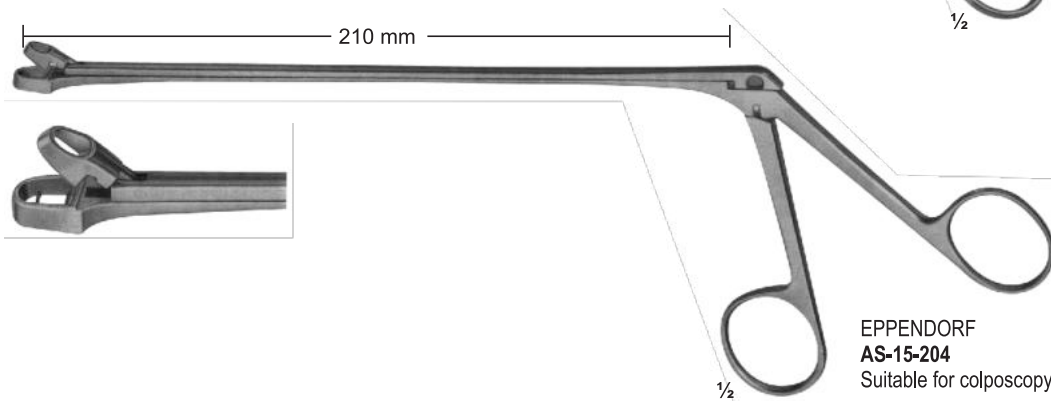
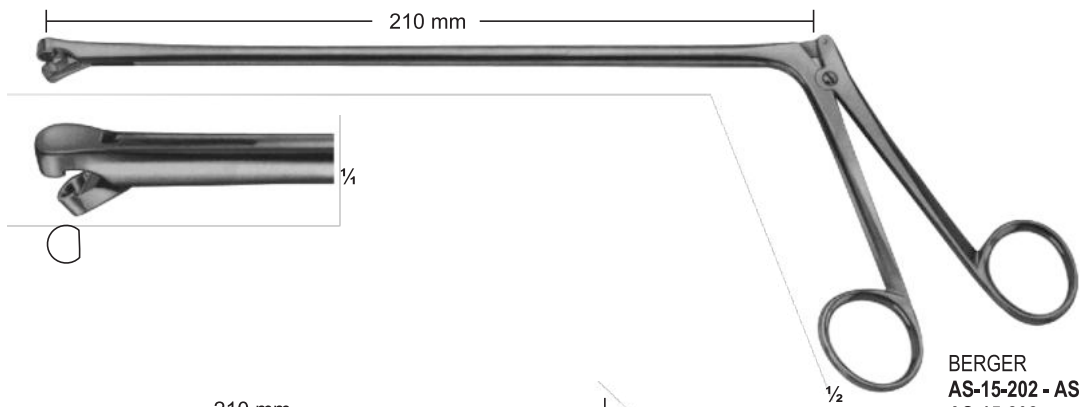
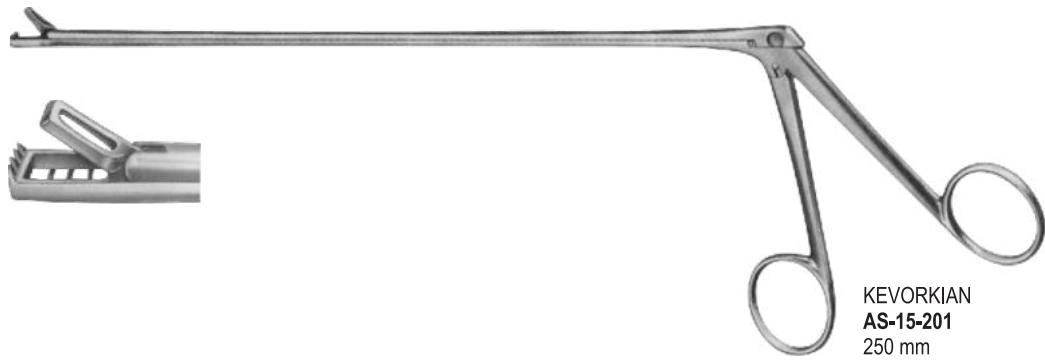
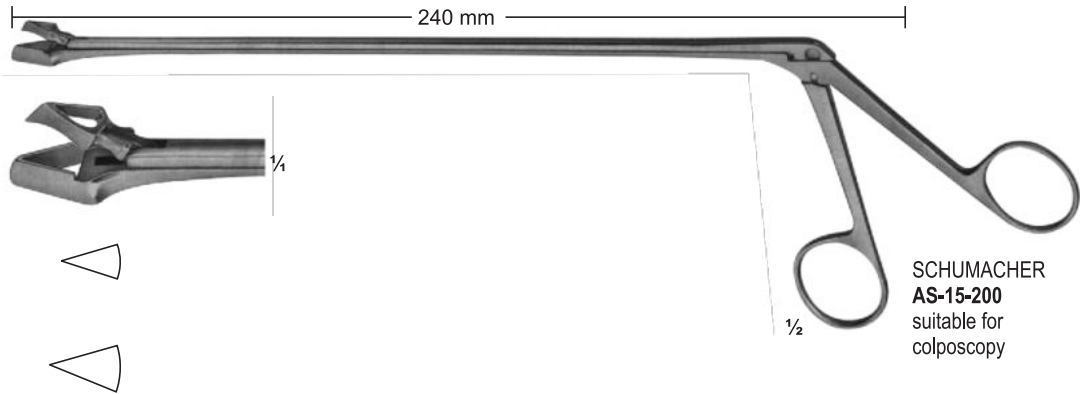

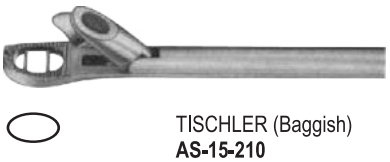
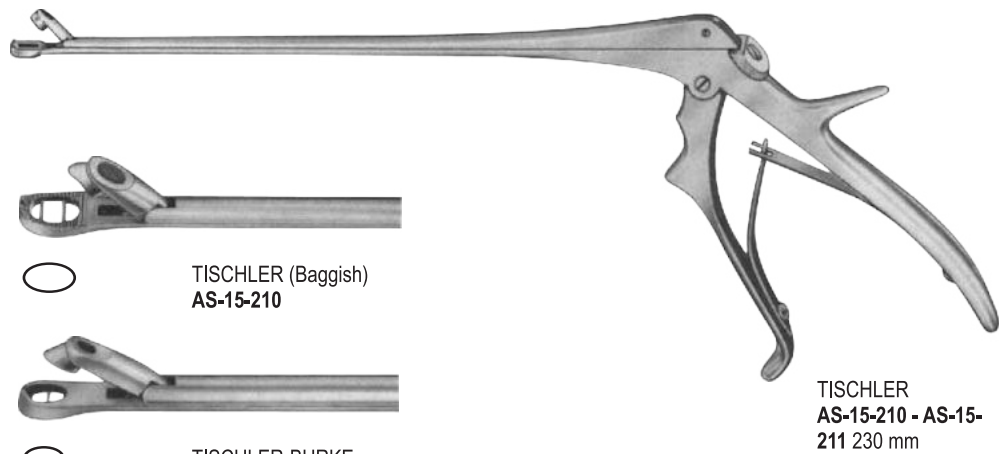
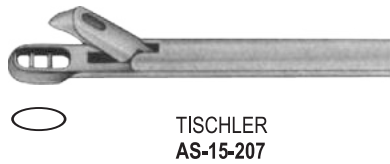
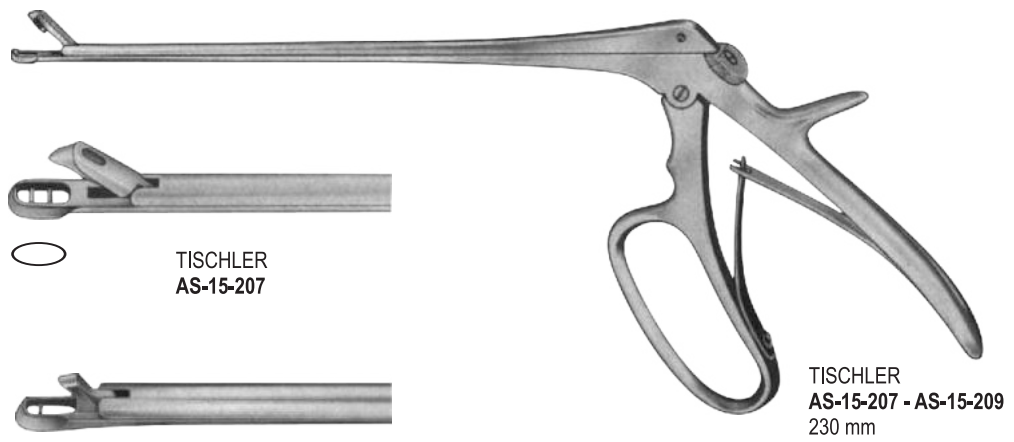

240 mm



1/2

SCHUMACHER
AS-112
suitable for
colposcopy

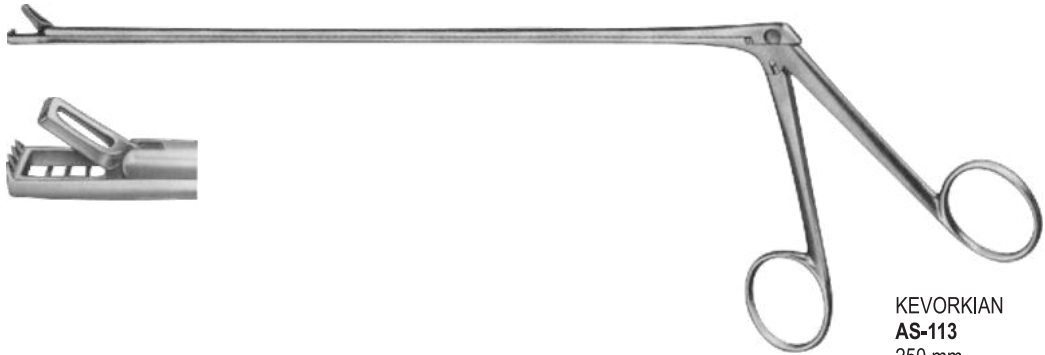

KEVORKIAN
AS-113
250 mm

210 mm



1/4

1/2

BERGER
AS-114 - AS-115
AS-114
19 cm / 3 mm
AS-115
19 cm / 5 mm

210 mm



1/2

EPPENDORF AS-116
Suitable for
colposcopy



WINTER
AS-117 - AS-118
AS-117 230 mm
 straight
AS-118 230 mm
 curved

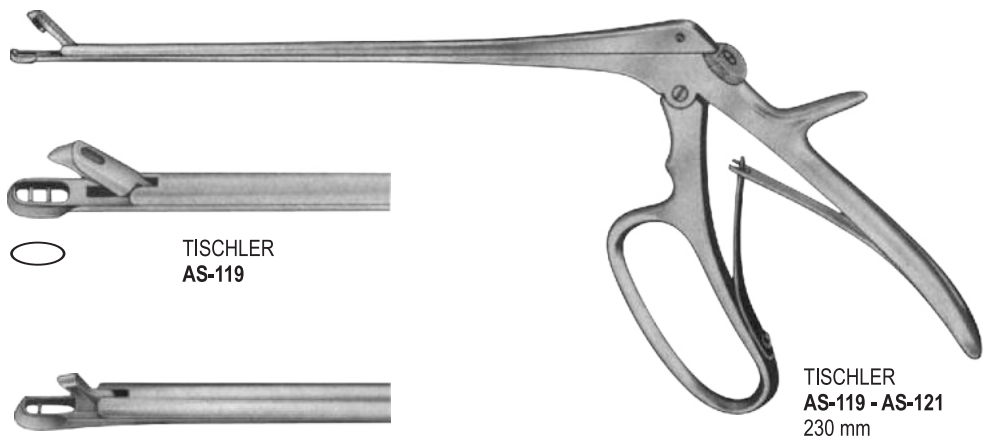

TISCHLER
AS-119

TISCHLER
AS-119 - AS-121
 230 mm



TISCHLER-MINI
AS-120



KEVORKIAN-PACIFIC
AS-121

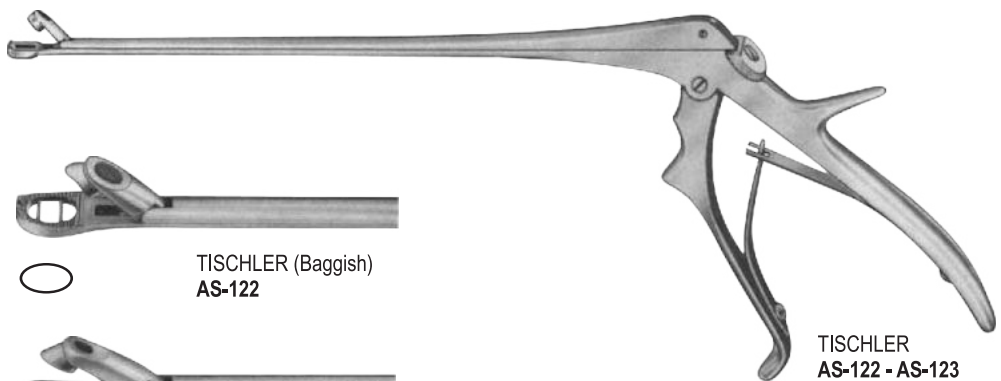

TISCHLER (Baggish)
AS-122

TISCHLER
AS-122 - AS-123
 230 mm



TISCHLER-BURKE
AS-123

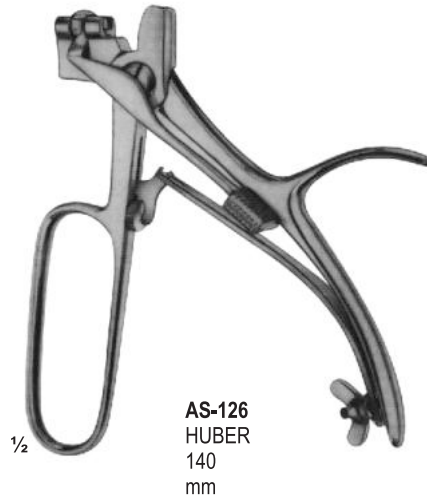
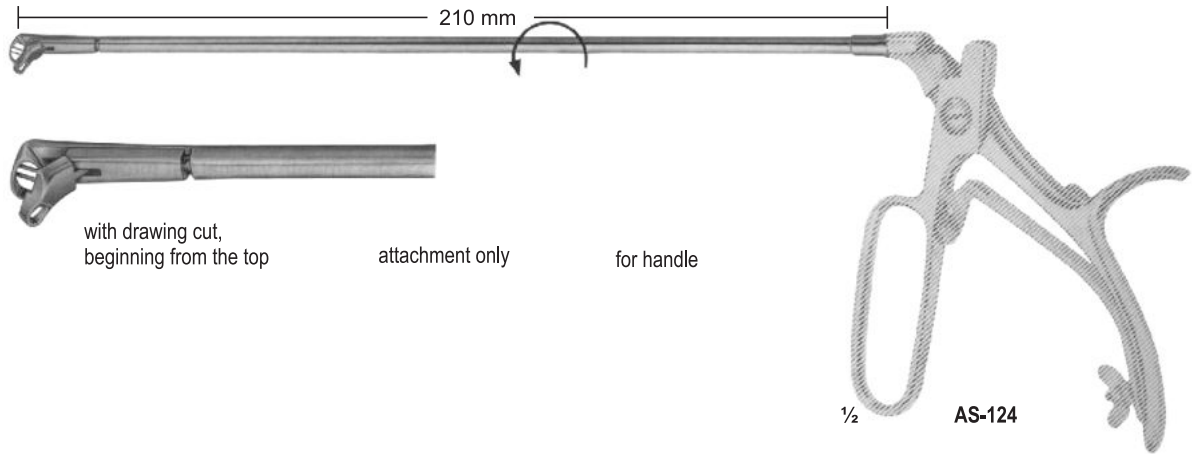

AS-127 BRUENINGS 200 mm Length
AS-128 BRUENINGS 250 mm Length



AS-129 KRAUSE (Biopsy tip)



AS-130 SCHEINMANN (Biopsy tip)



AS-131 SCHEINMANN (Biopsy tip)
with drawing cut

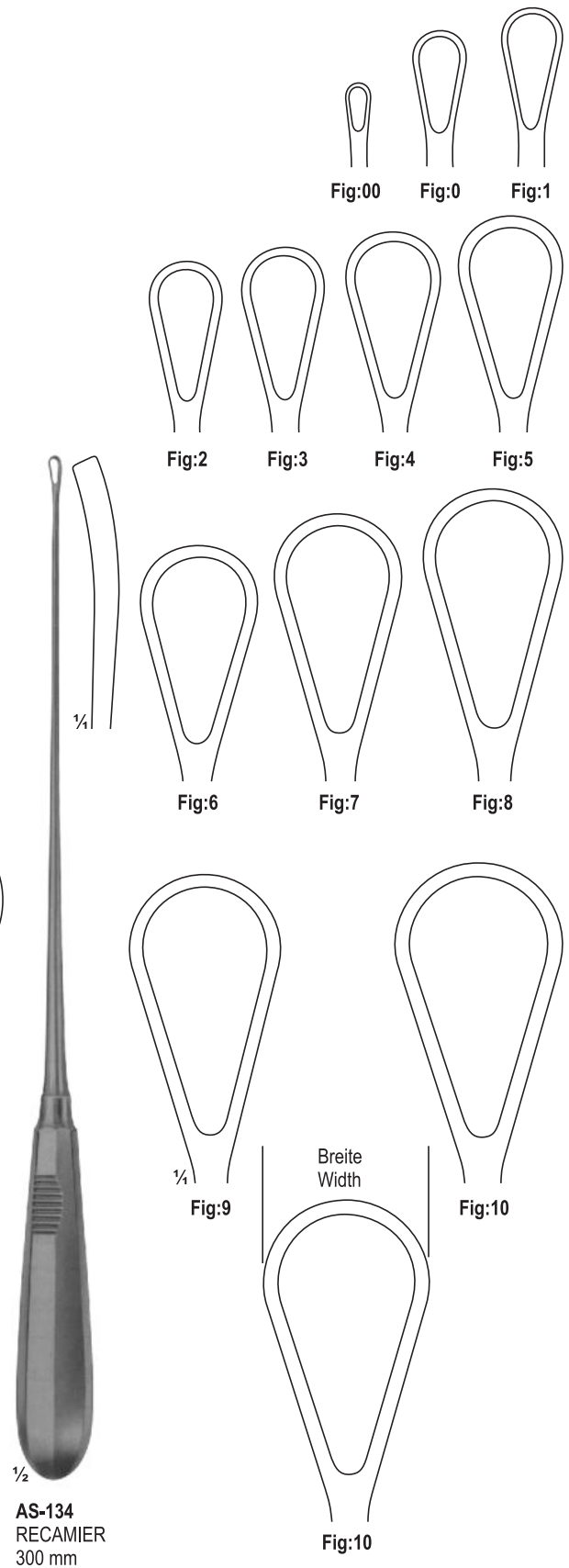
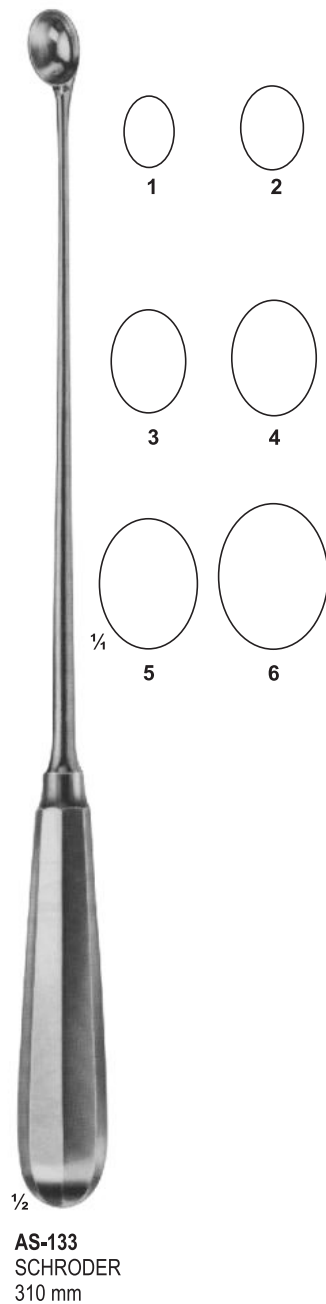
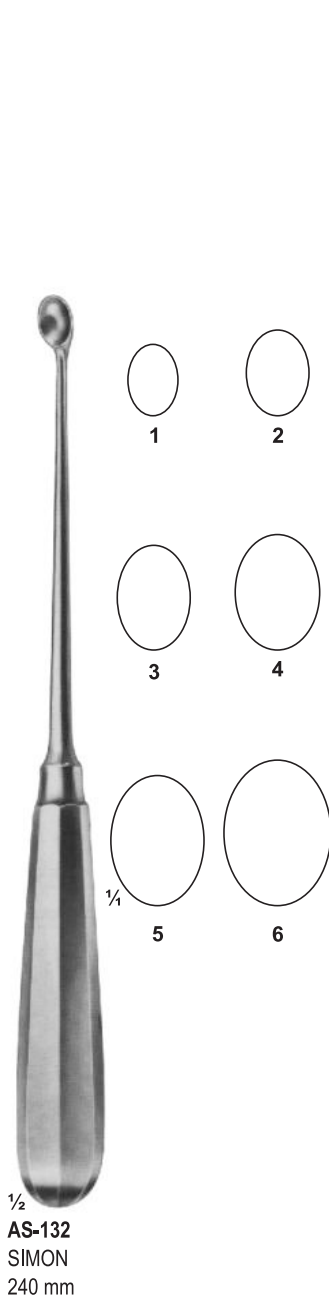



AS-138
COLLIN
300 mm



AS-139
RECAMIER
blunt-rigid
360 mm

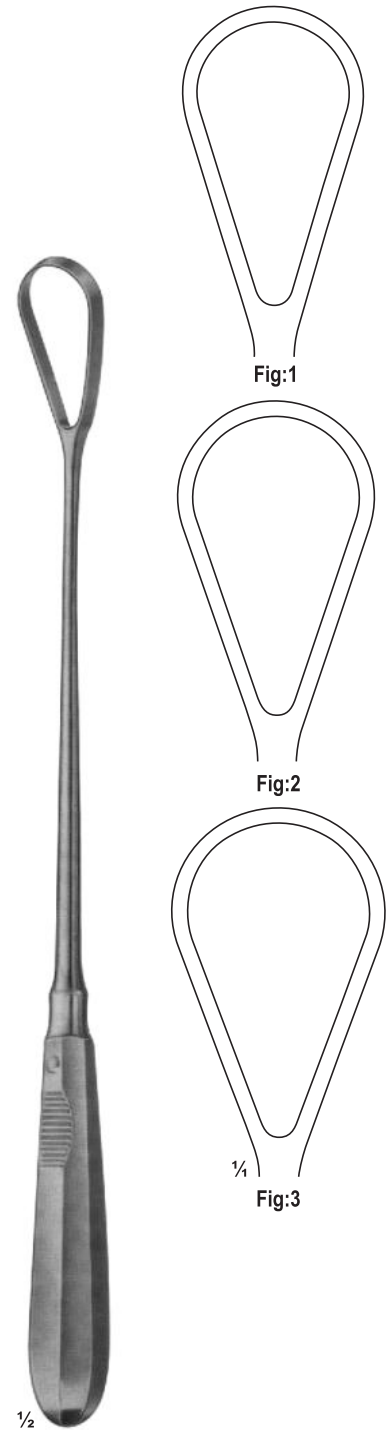
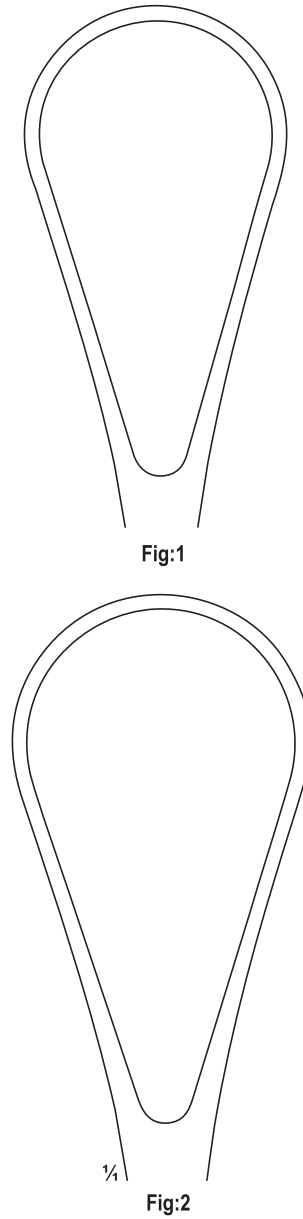

AS-140
BUMM
310 mm

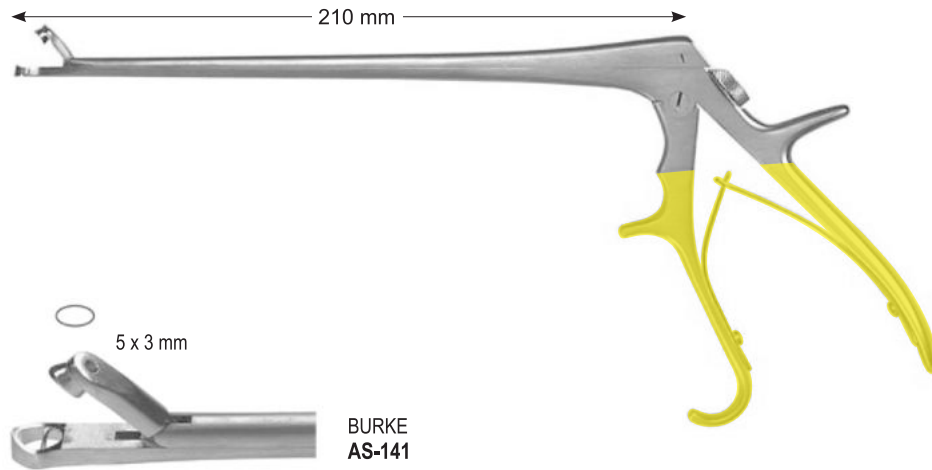

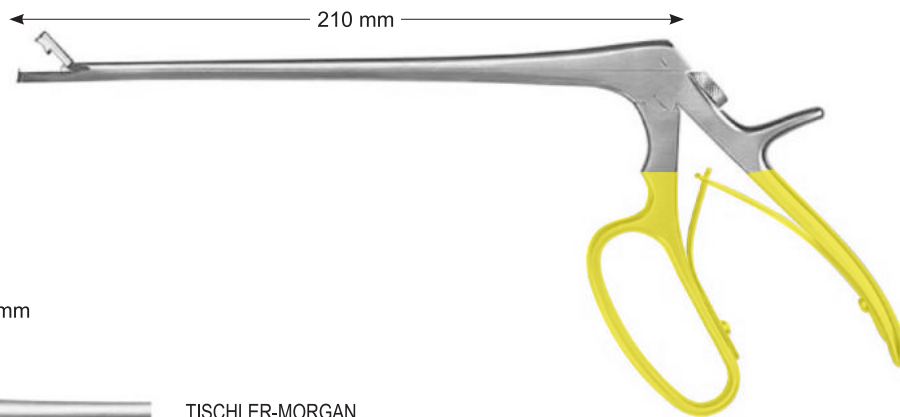

7 x 3 mm



TISCHLER-MORGAN
AS-142

2.3 x 4 mm



MINI-TOWNSEND
AS-143

9 x 3 mm



TISCHLER-KEVORKIAN
AS-145

2.3 x 4 mm



BABY-TISCHLER
AS-144

9 x 3 mm



KEVORKIAN-PACIFIC
AS-146



ASAMAR
SURGICAL 

PAGE **312-374**

**CARDIOVASCULAR
& THORACIC SURGERY
MULLER VESSEL CLIPS
BULLDOG CLAMPS**

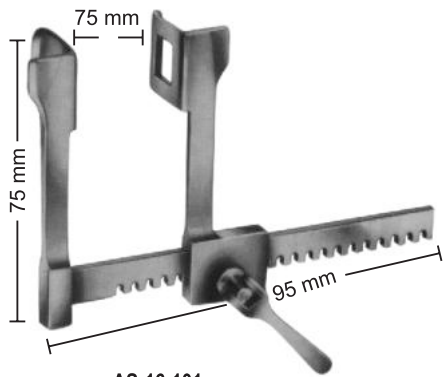

AS-16-101
FINOCHIETTO
for children
18X21 mm

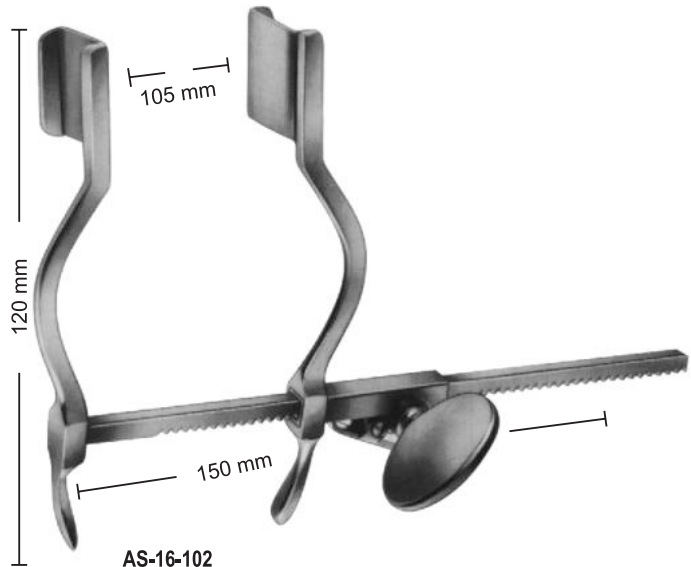

AS-16-102
HERTZLER
for children
20X25 mm

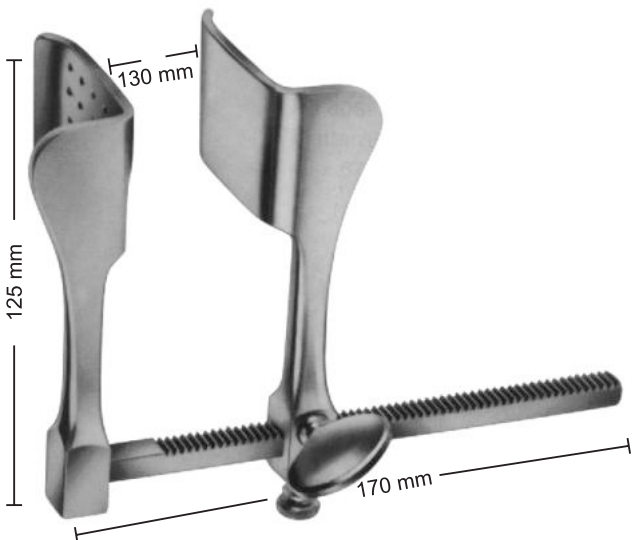

AS-16-103
TUFFIER
Blades
43X53 mm

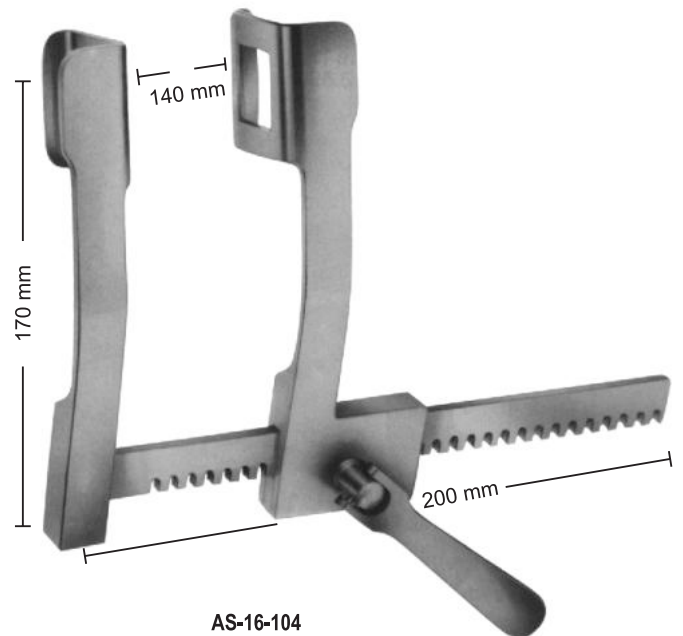

AS-16-104
FINOCHIETTO
Blades
36X45 mm

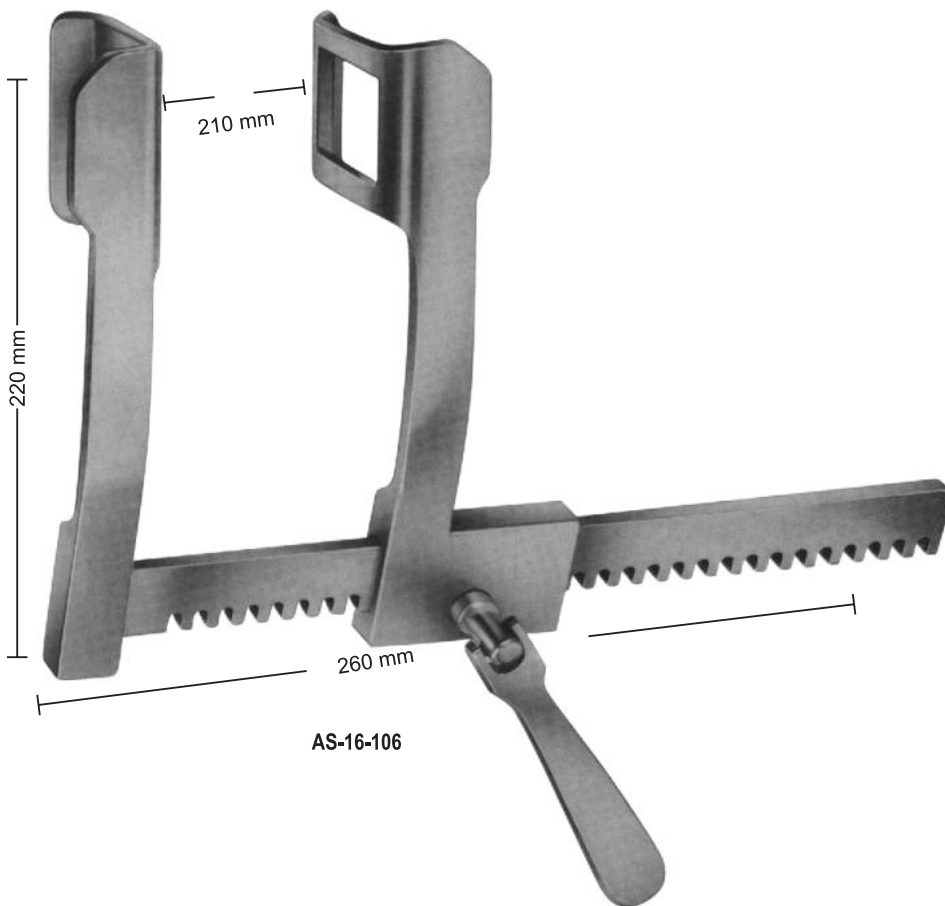
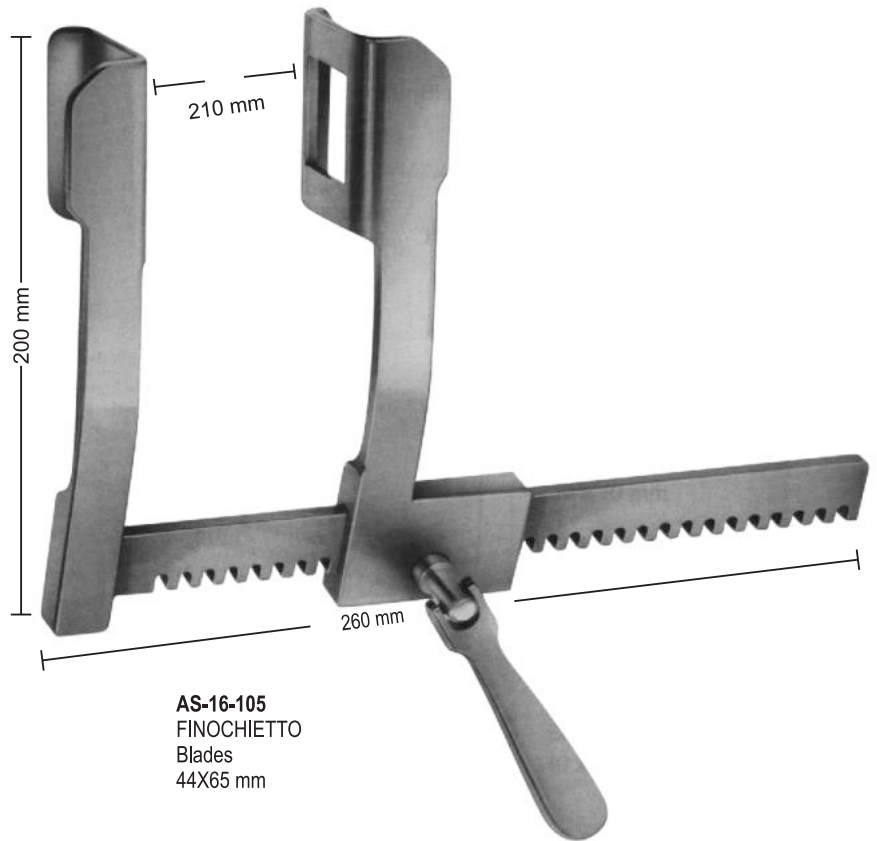

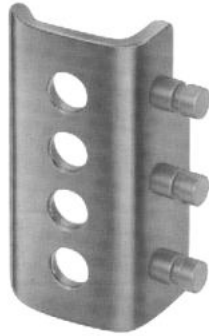

AS-16-107 Blades
46x67 mm



AS-16-109 Blades
46x67 mm

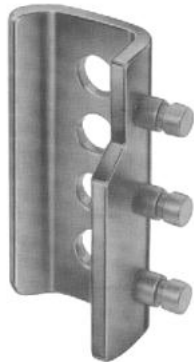

AS-16-108 Blades
80x67 mm

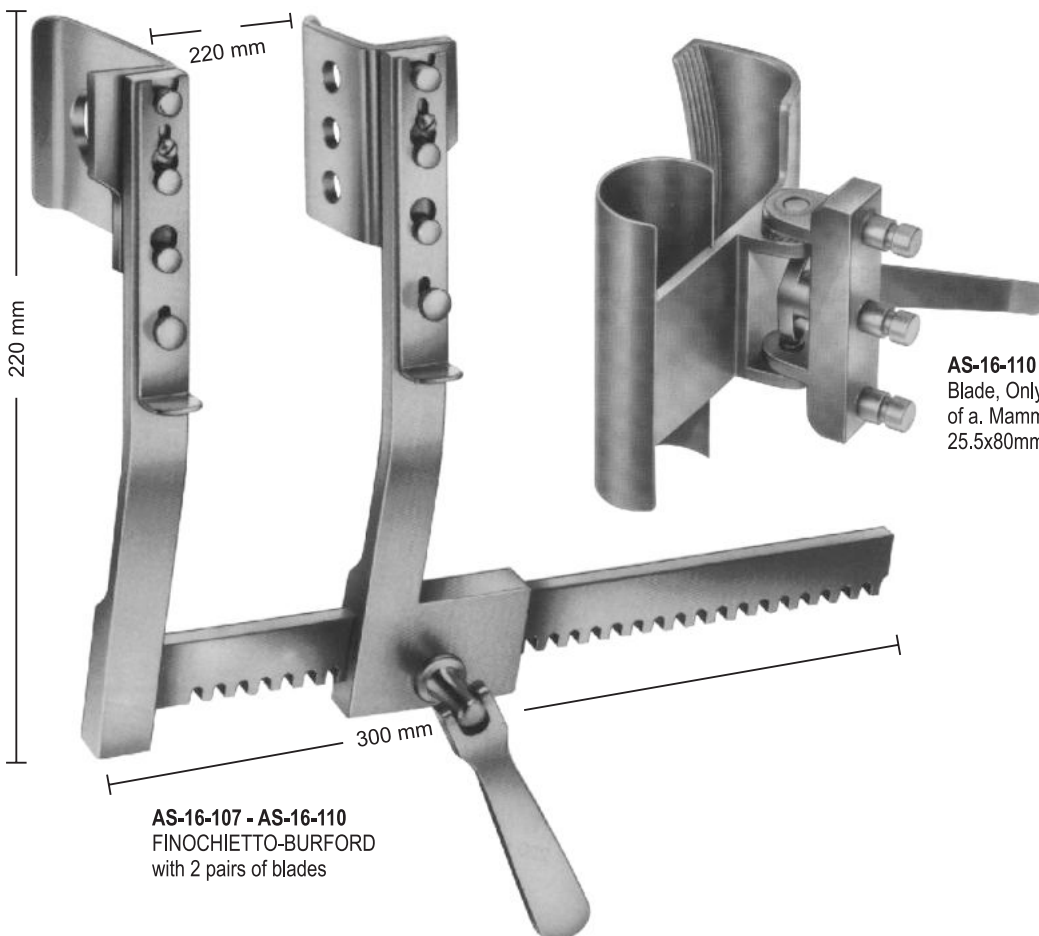
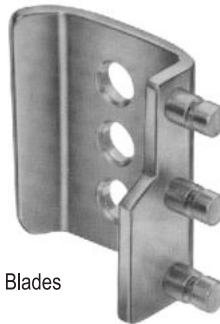

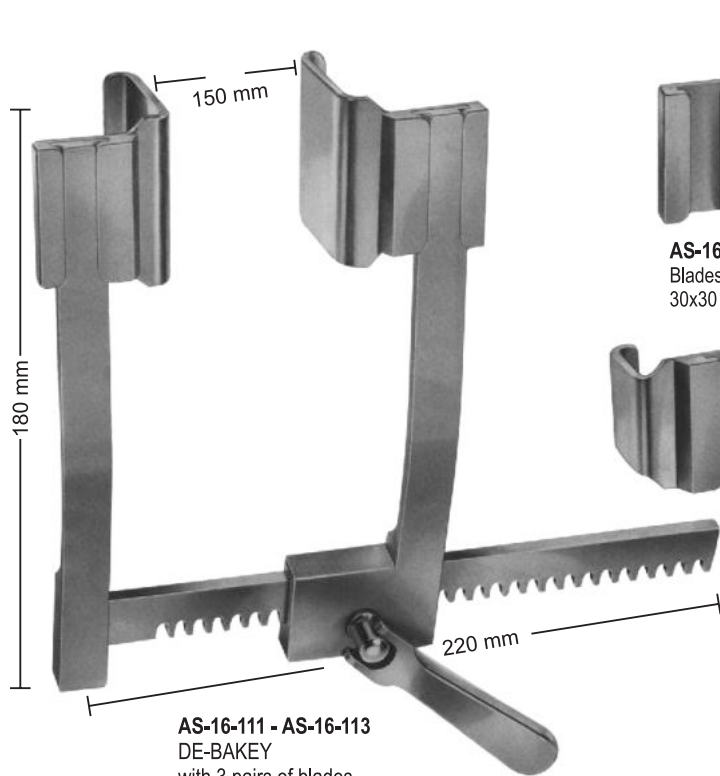

AS-16-111 - AS-16-113
DE-BAKEY
with 3 pairs of blades

AS-16-111
Blades
30x30 mm

AS-16-112
Blades
40x40 mm

AS-16-113
Blades
50x50 mm

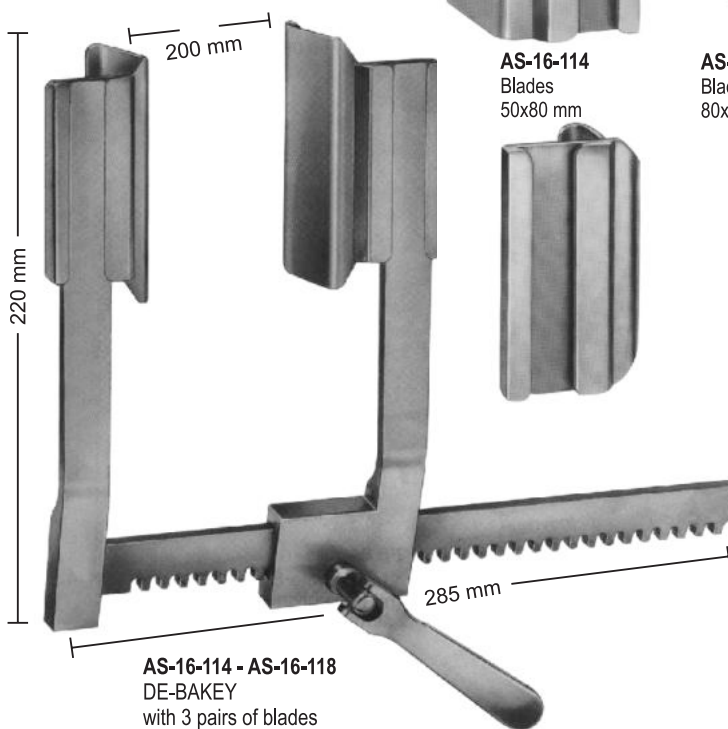

AS-16-114 - AS-16-118
DE-BAKEY
with 3 pairs of blades

AS-16-114
Blades
50x80 mm

AS-16-115
Blades
80x60 mm

AS-16-116
Blades
50x80 mm

AS-16-117
Blades
40x100 mm

AS-16-118
Sternotomy Blades
50x660 mm

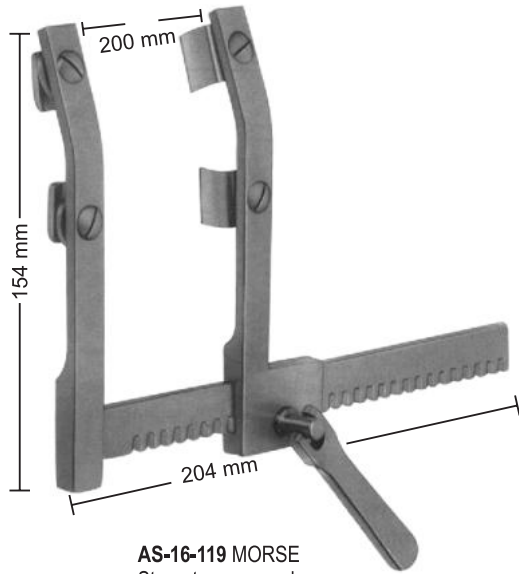

AS-16-119 MORSE
Sternotomy spreader
for children, with
moveable double, each
blade
12x20 mm

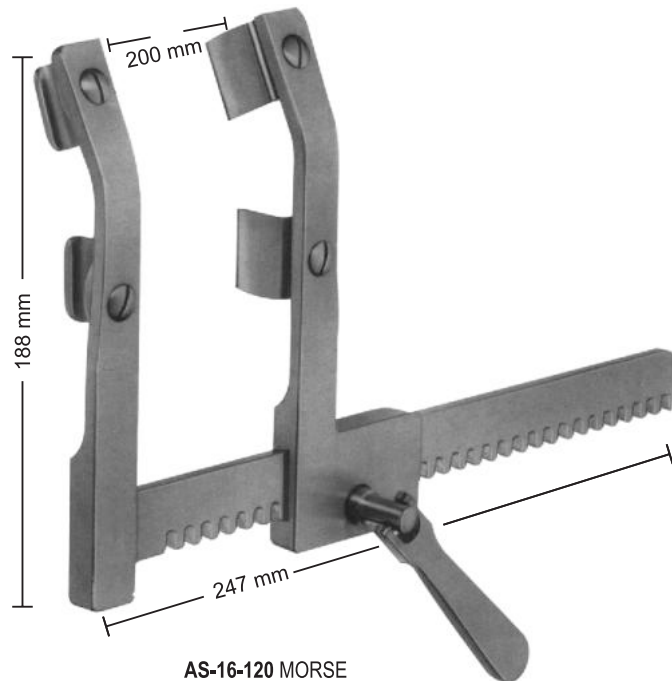

AS-16-120 MORSE
Sternotomy spreader
for adults, with
moveable double, each
blade 19x19 mm

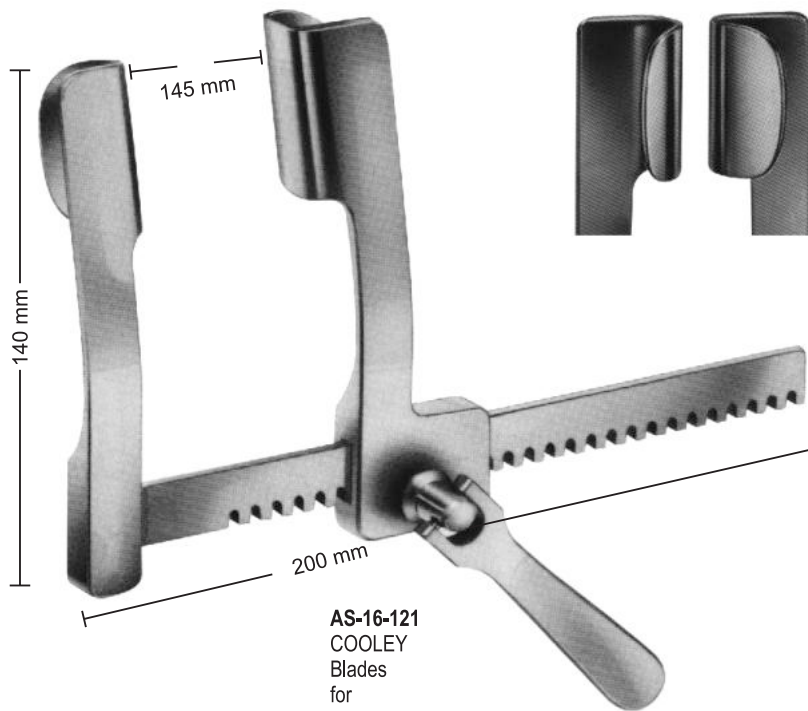

AS-16-121
COOLEY
Blades
for
children
21x45mm

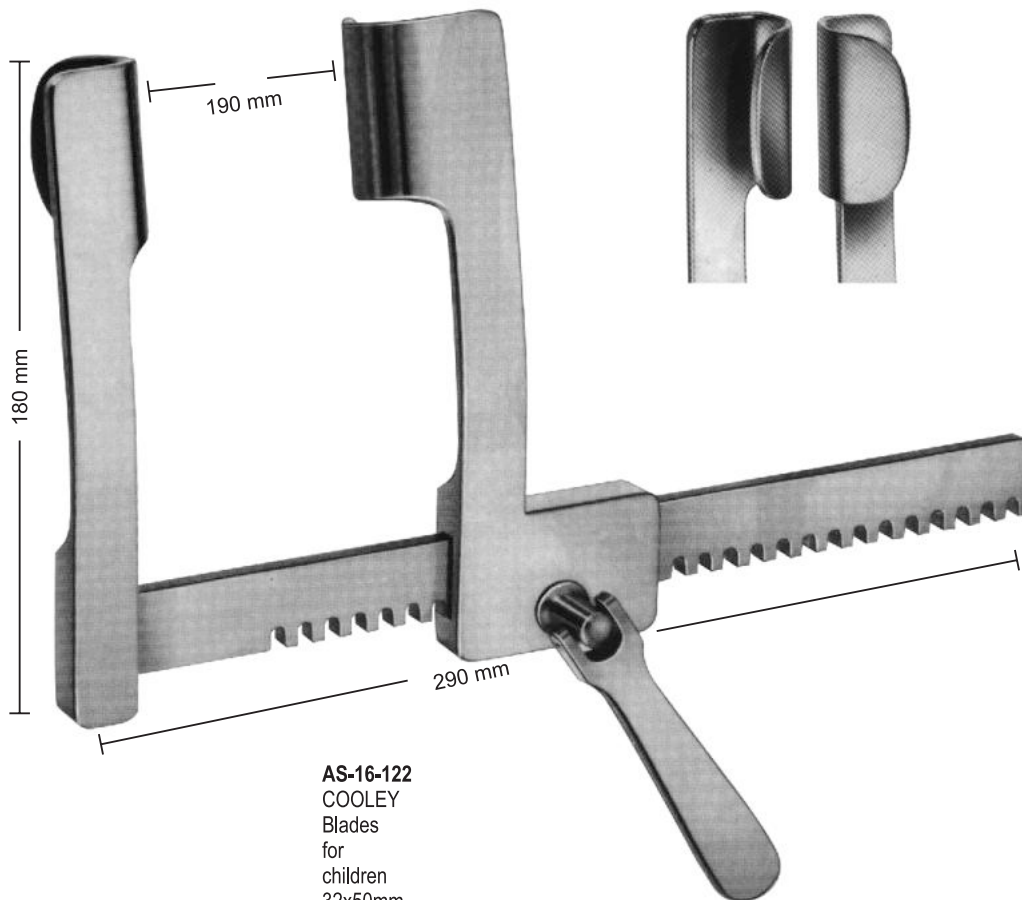

AS-16-122
COOLEY
Blades
for
children
32x50mm

STAINLESS STEEL

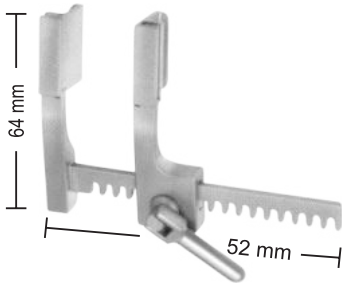

AS-16-123 - AS-16-124
for blades, with 2 pairs of blades
9X20 mm 9X10 mm, spreading 52
mm



AS-16-123
Blades,
only 9x20
mm



AS-16-124
Blades,
only 9x10
mm

ALUMINIUM

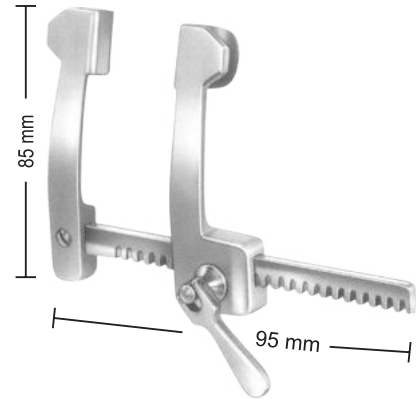

COOLEY AS-16-125
for blades, lateral blades 12X16 mm,
spreading 95 mm

ALUMINIUM

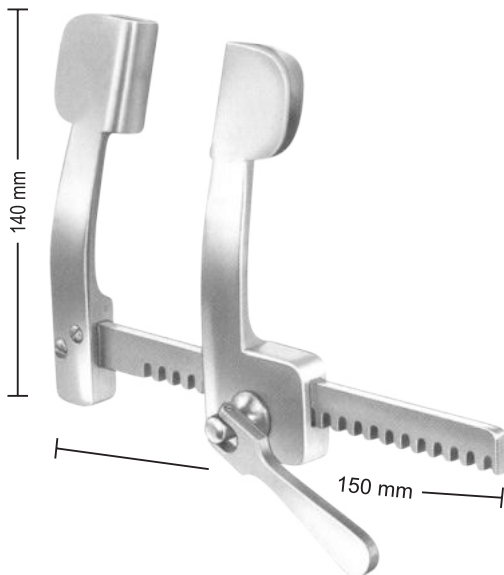

COOLEY AS-16-126
for children, lateral blades 21X44 mm,
spreading 150 mm

ALUMINIUM

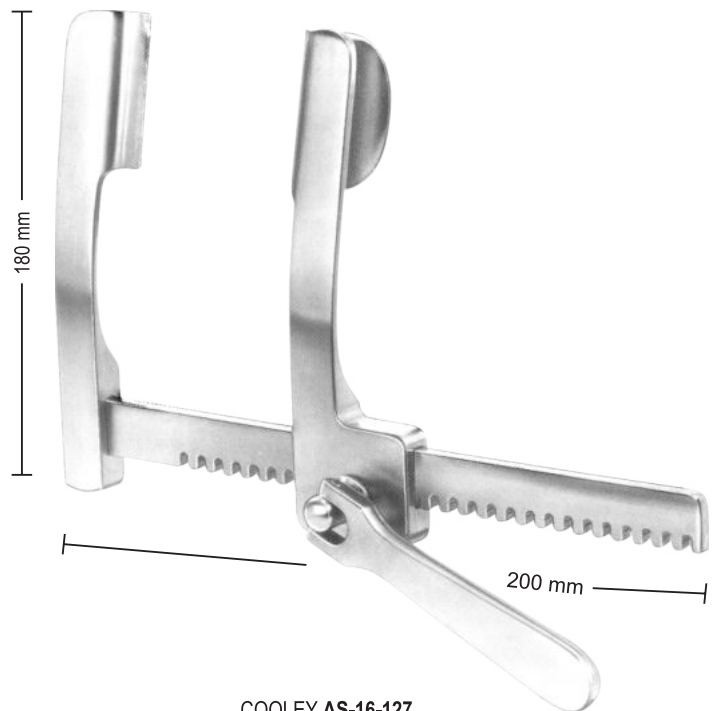

COOLEY AS-16-127
for adults, lateral blades 35X50 mm,
spreading 200 mm

ALUMINIUM

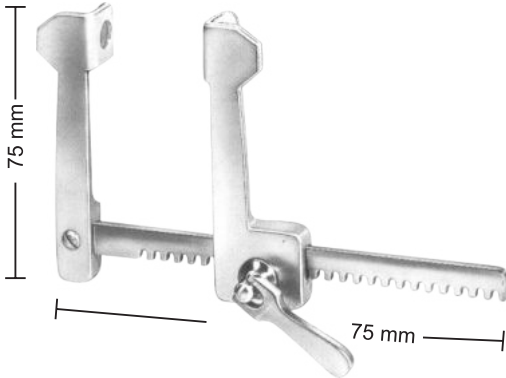

FINOCHIETTO, INFANT **AS-16-128**
for children, lateral blades 15X15 mm,
spreading 75 mm

STAINLESS STEEL

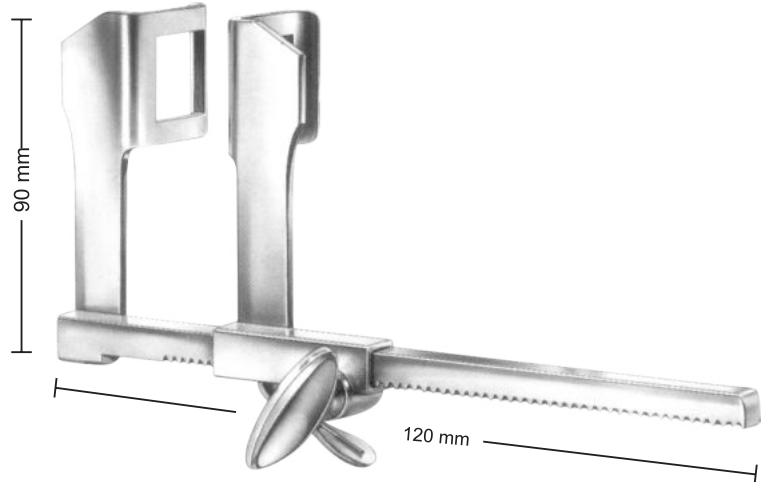

HAIGHT **AS-16-129**
lateral blades 30X30 mm,
spreading 120 mm

ALUMINIUM

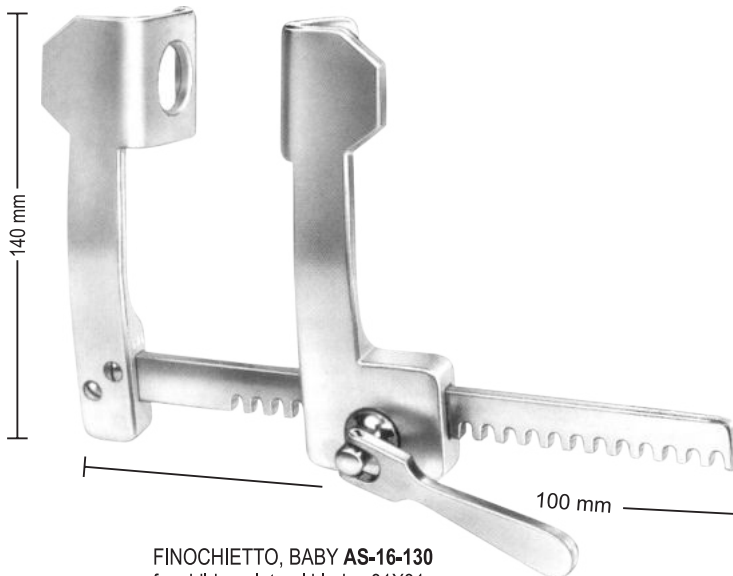

FINOCHIETTO, BABY **AS-16-130**
for children, lateral blades 31X31 mm,
spreading 100 mm

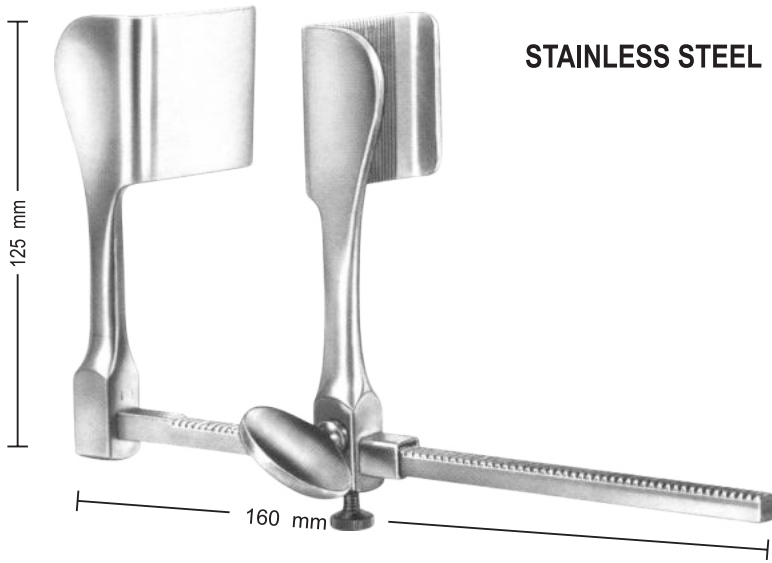

STAINLESS STEEL

TUFFIER AS-16-131
lateral blades 45X45 mm,
spreading 160 mm

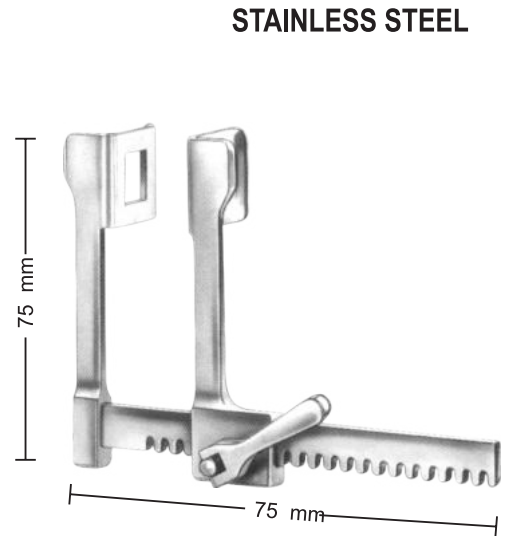

STAINLESS STEEL

FINOCHIETTO, BABY AS-16-132
lateral blades 14X15 mm,
spreading 75 mm



STAINLESS STEEL

FINOCHIETTO AS-16-133
lateral blades 30X45 mm, 46X62 mm, 80X65 mm,
spreading 150 mm, 190 mm, 190 mm



AS-16-135
Blades
75x75 mm

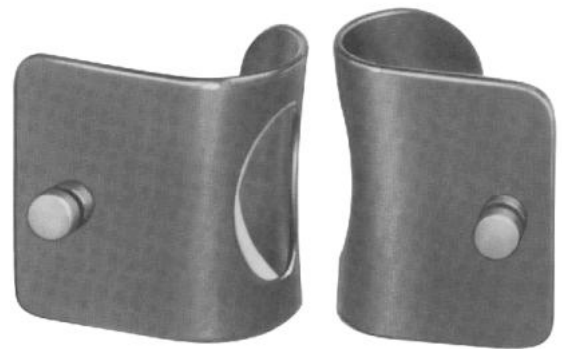

AS-16-136
Blades
42x65 mm



Blades with Ball Snap System
Delivery: in Pairs

- AS-16-134 - AS-16-136**
Thoraxsperrer (Mercedes-Sperrer)
complete consisting of:
AS-16-134 Retractor only
AS-16-135 1 Pair of blades 42x65 mm
AS-16-136 1 Pair of blades 75x75 mm



AS-16-137 SELLORS
Rib spreader and contractor
with swivel blades
200 mm



AS-16-138
BAILEY 150
mm



AS-16-139
for children

AS-16-140
for children

AS-16-139 - AS-16-141
BAILEY
200 mm

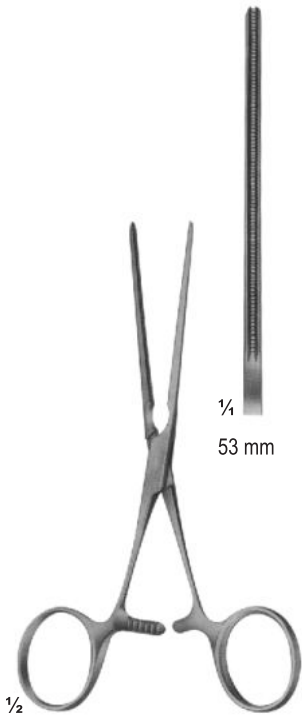

AS-16-142 DE-BAKEY gerade straight 130 mm

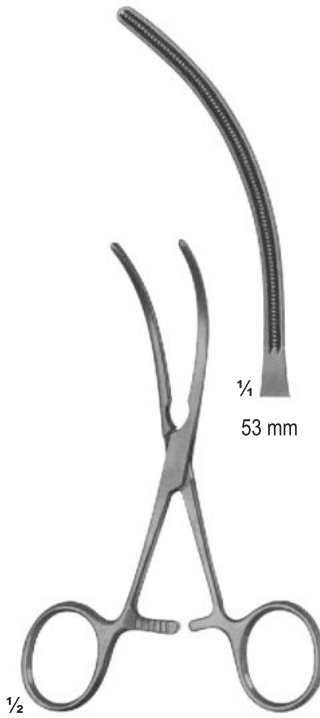

AS-16-143 DE-BAKEY Maul gebogen curved jaws 125 mm

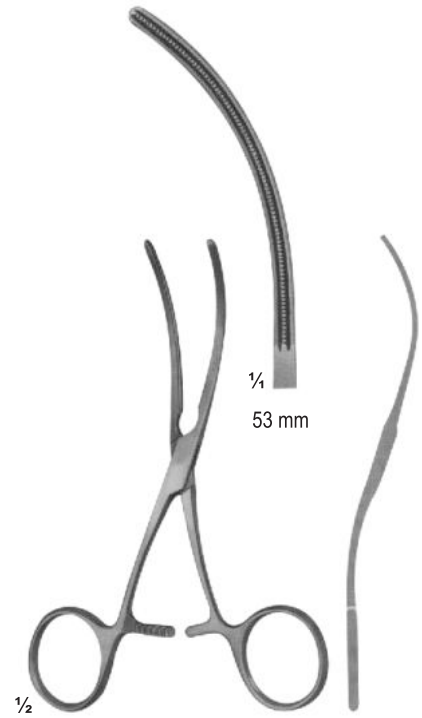

AS-16-144 DE-BAKEY S-shaped curved 125 mm

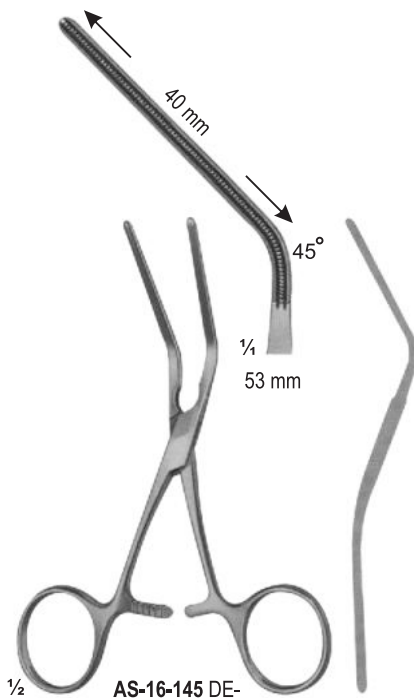

AS-16-145 DE-BAKEY 45° winklig gebogen angled 45 125 mm

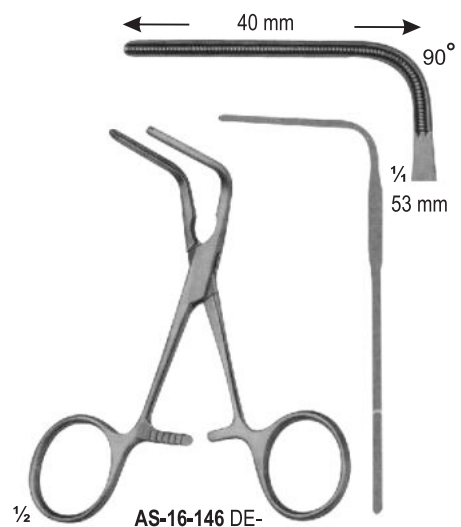

AS-16-146 DE-BAKEY 90° winklig gebogen angled 90 105 mm

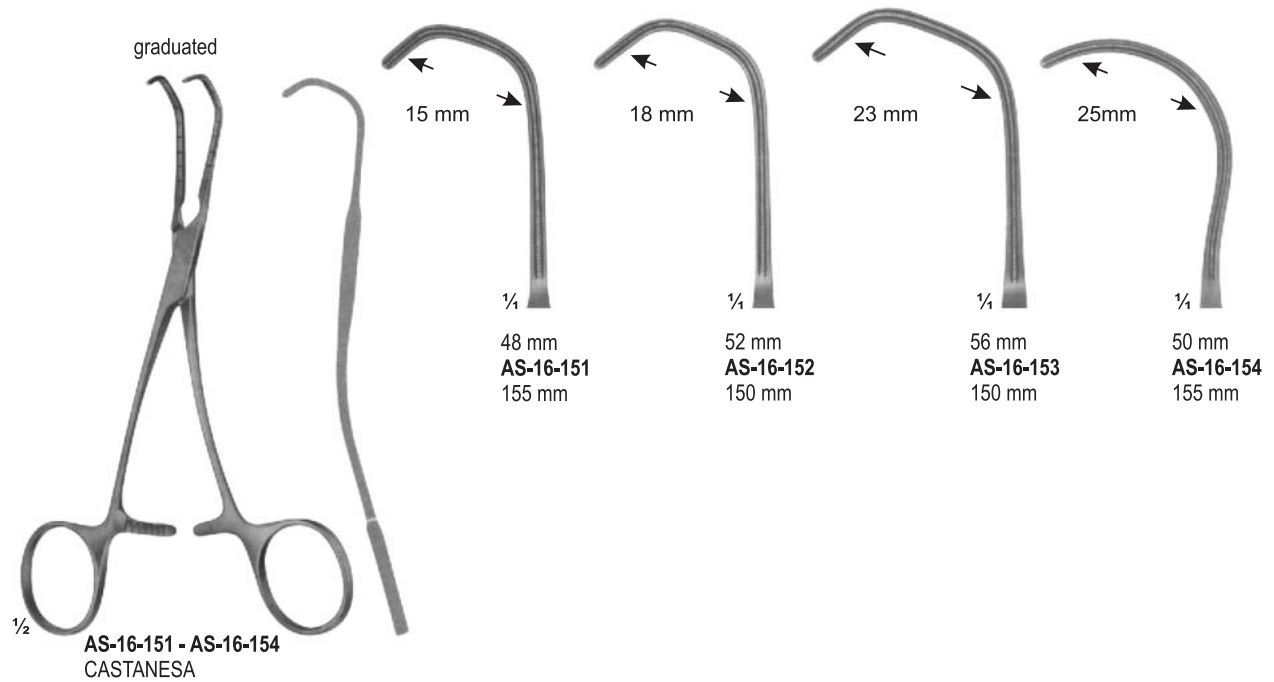
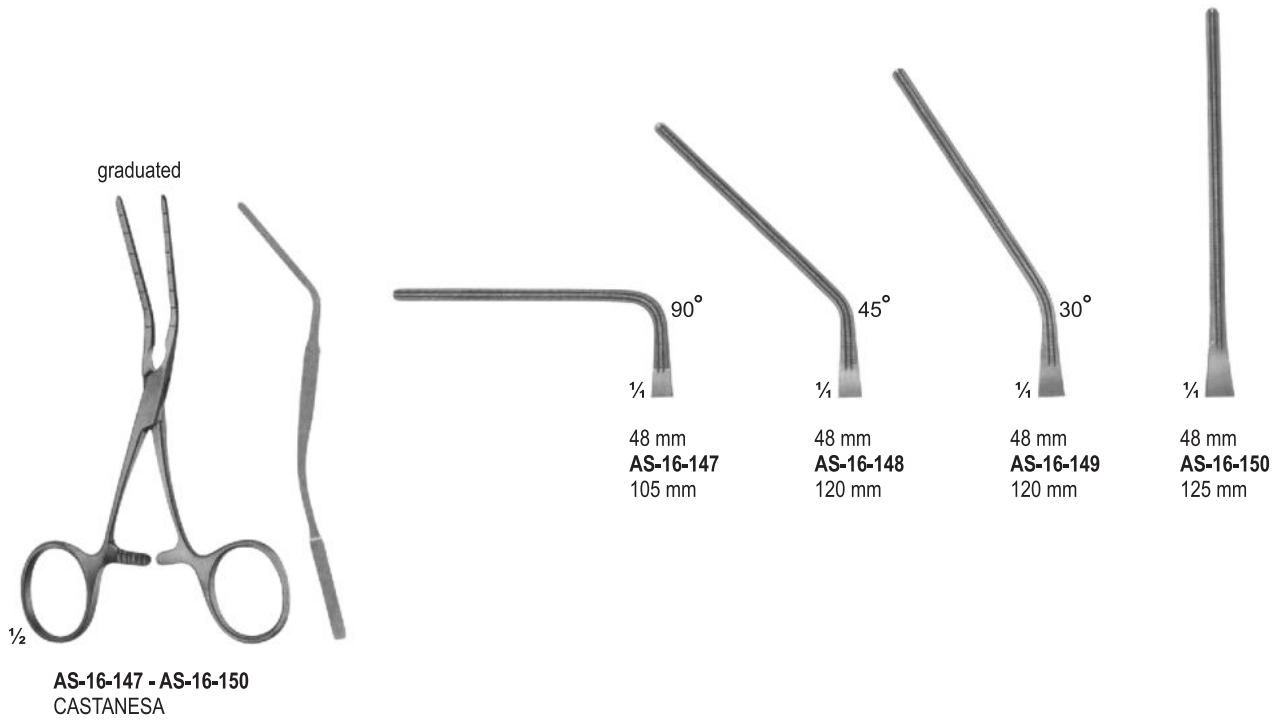

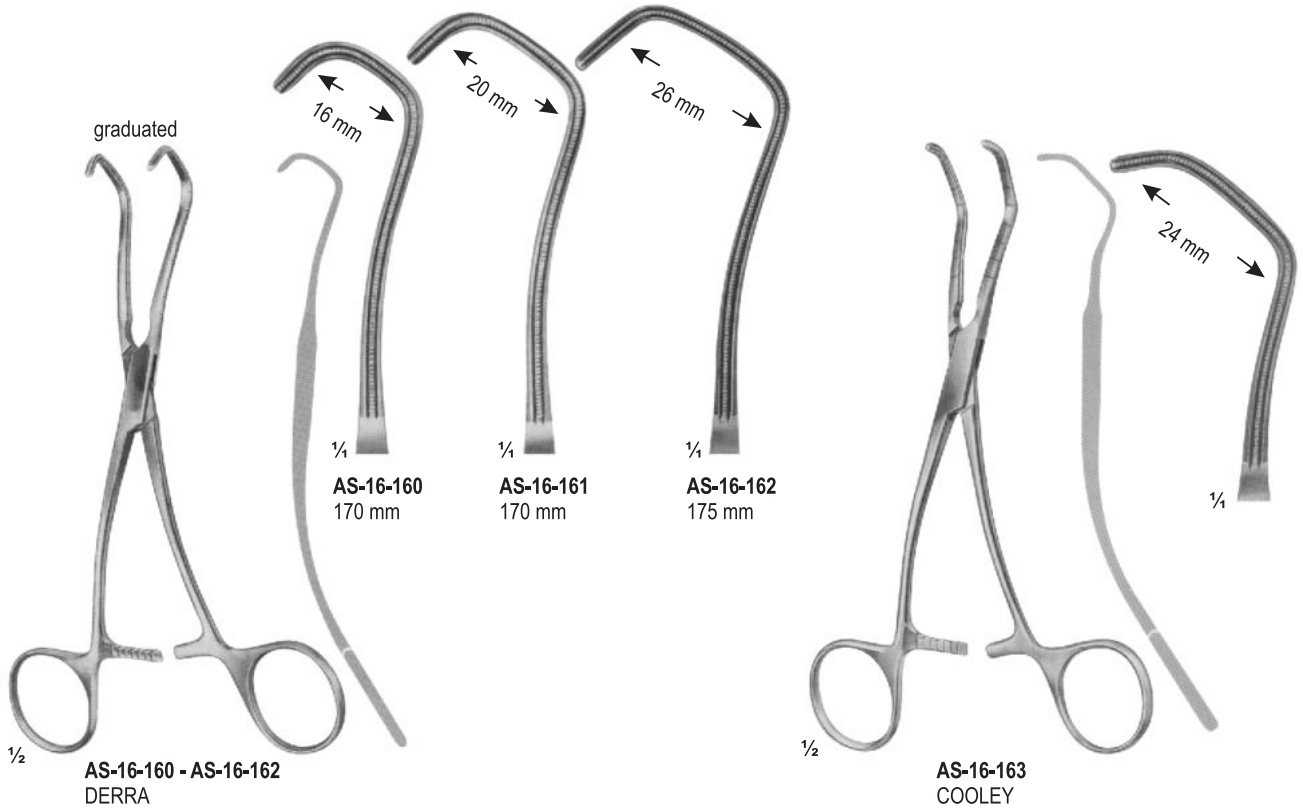
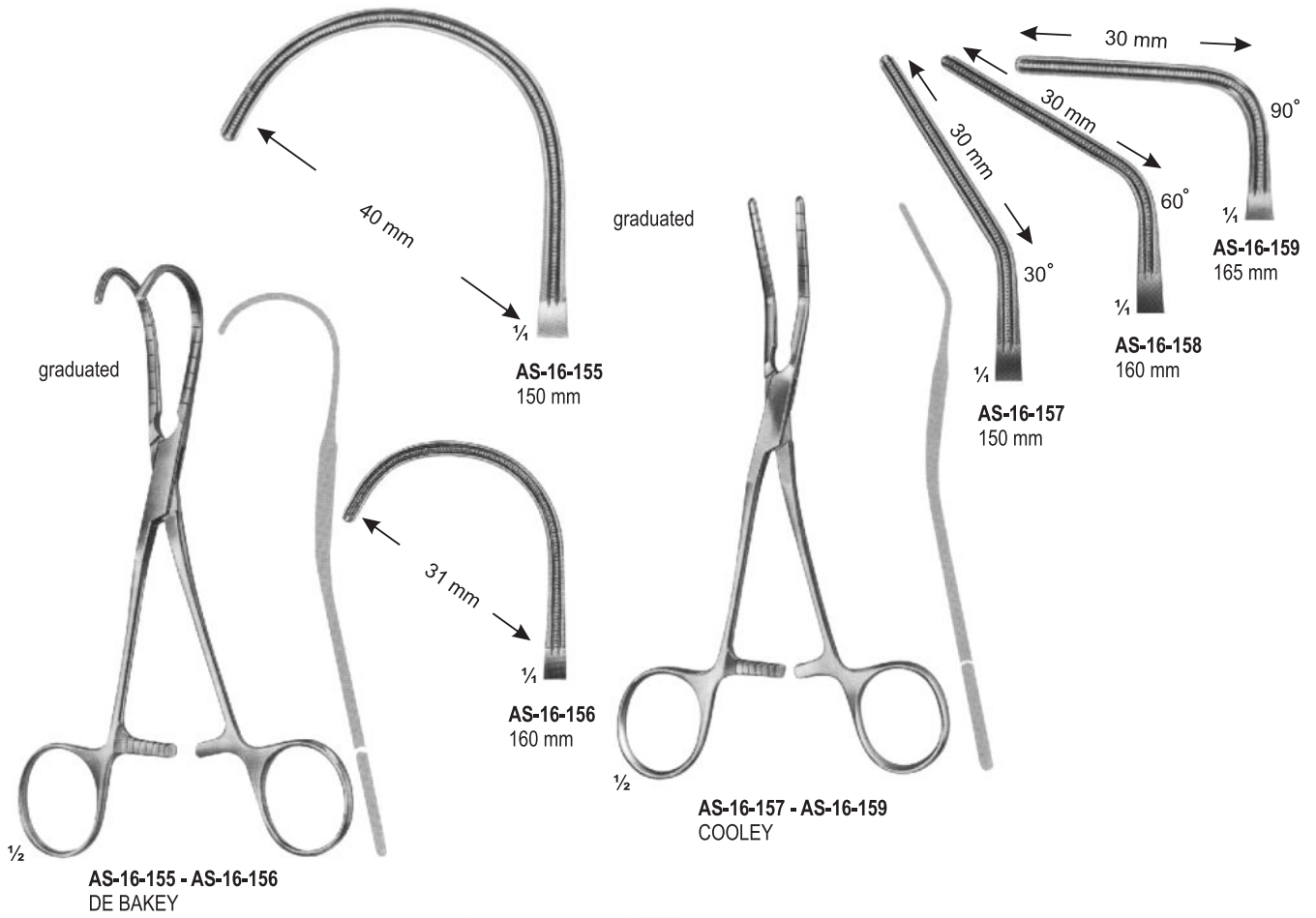

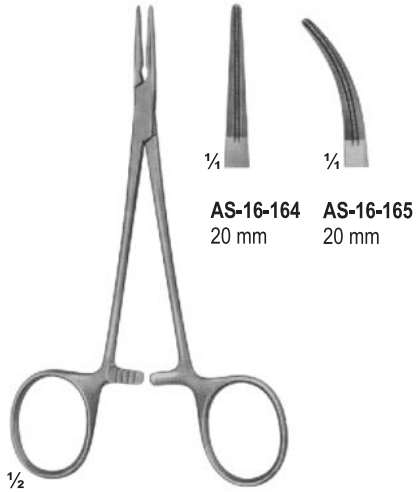

AS-16-164 - AS-16-165
HALSTED
125 mm

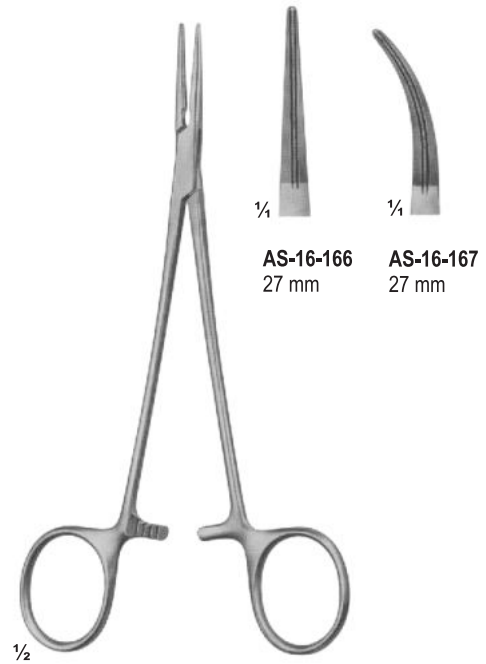

AS-16-166 - AS-16-167
RANKIN
165 mm

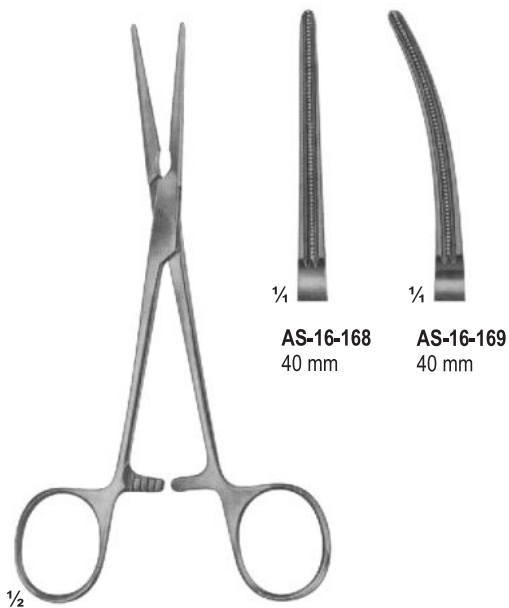

AS-16-168 - AS-16-169
DE BAKEY-BAINRIDGE
155 mm

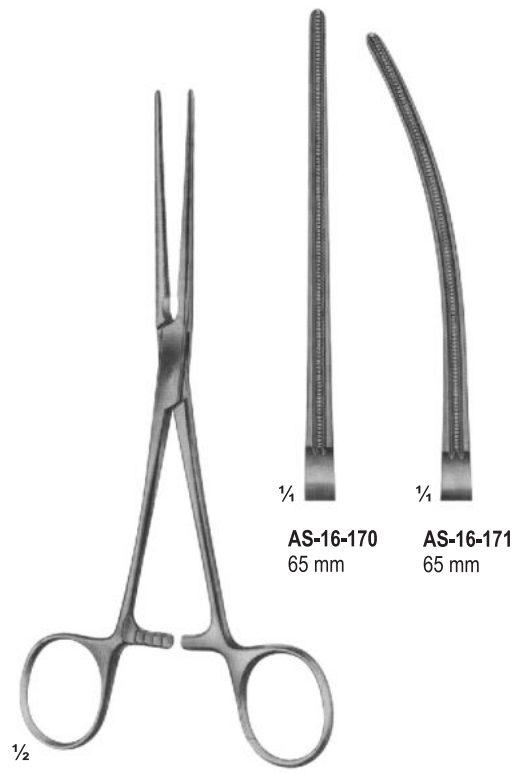

AS-16-170 - AS-16-171
DE BAKEY-BAINRIDGE
180 mm

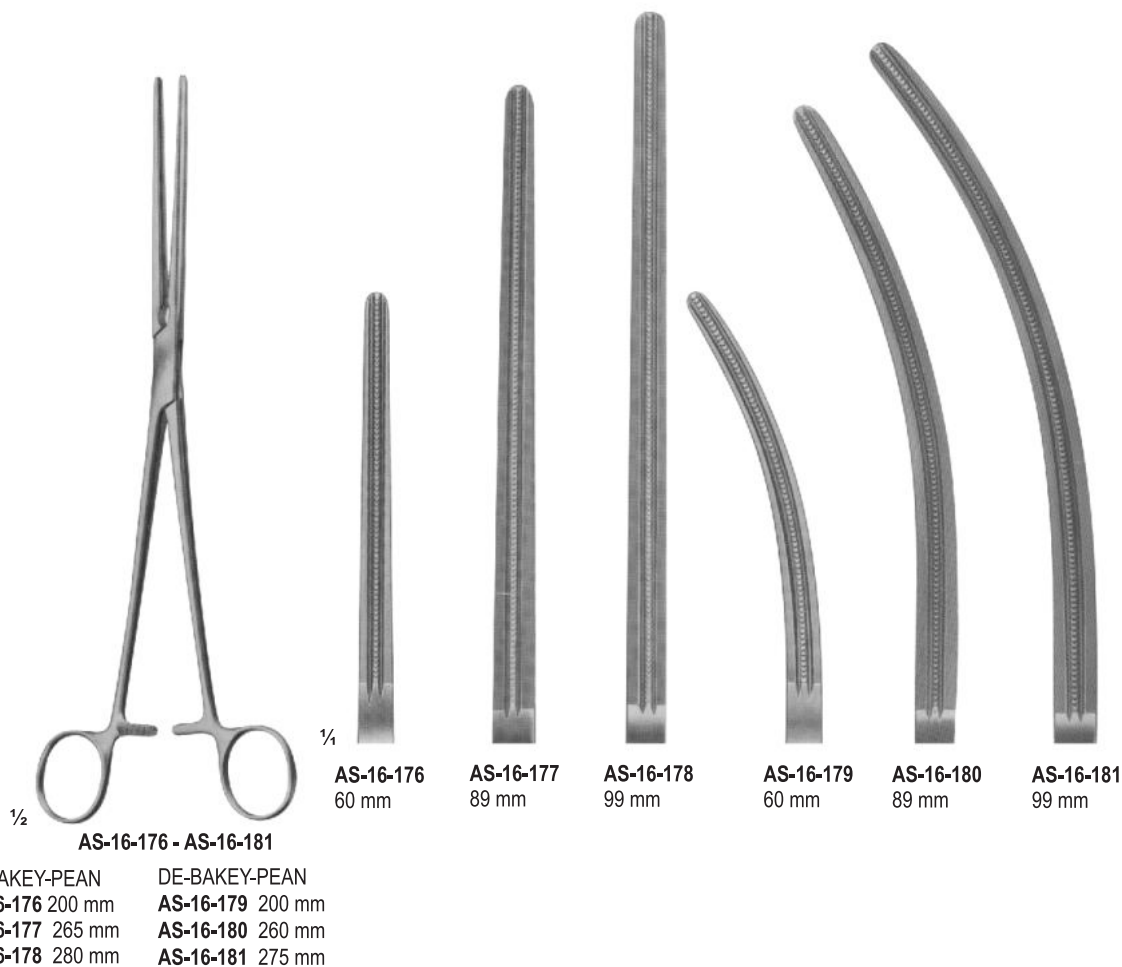
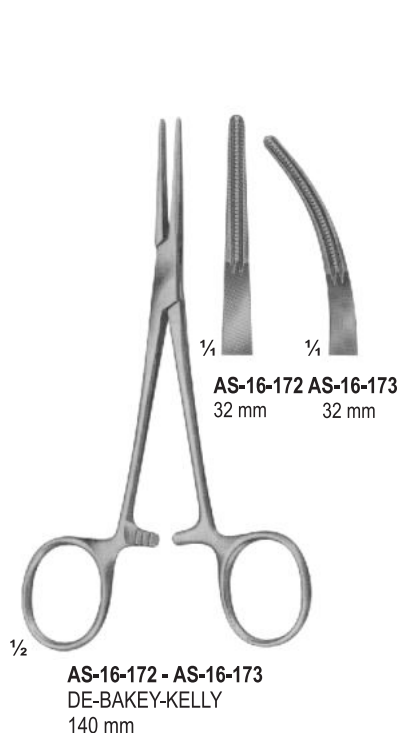

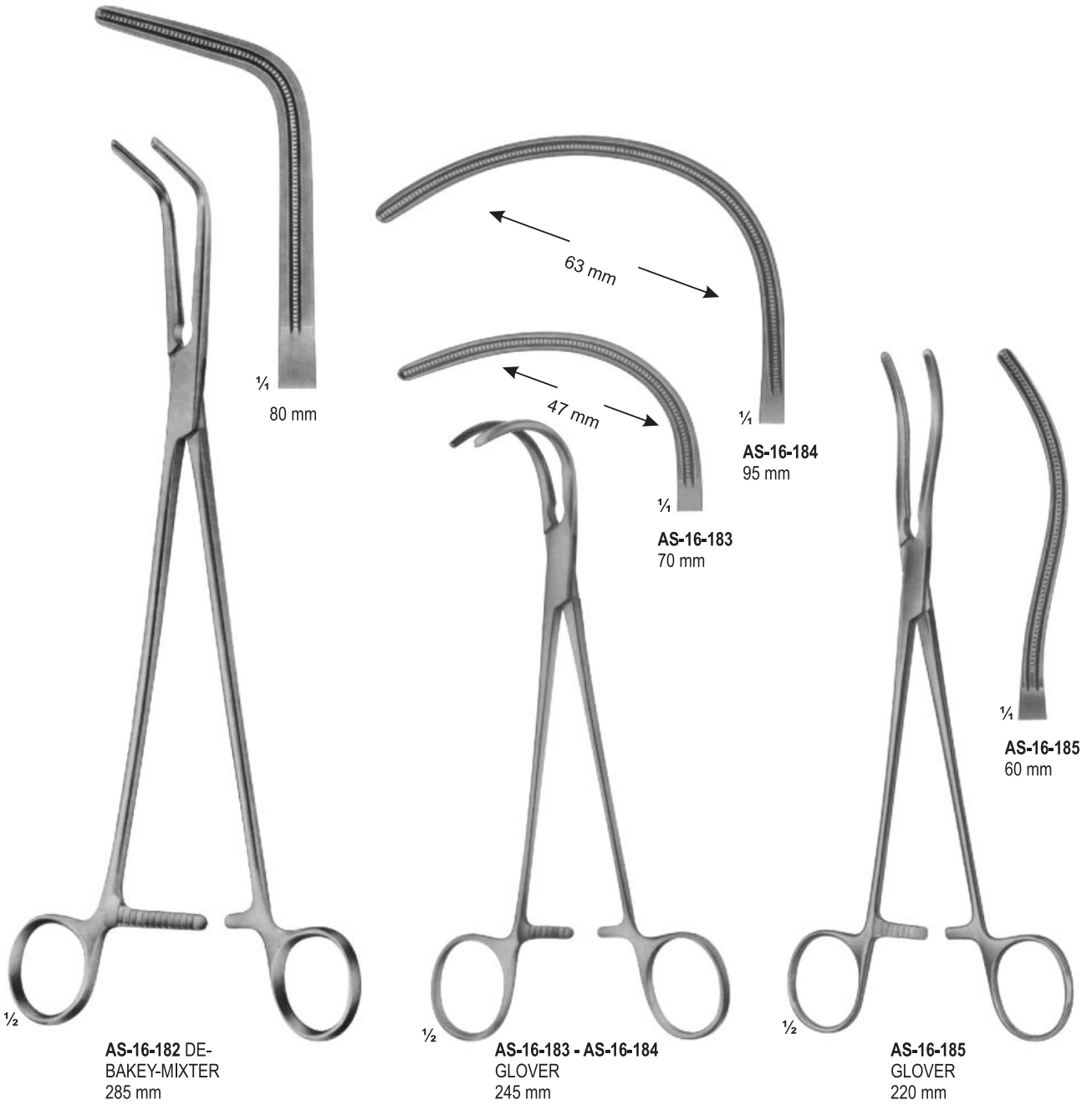

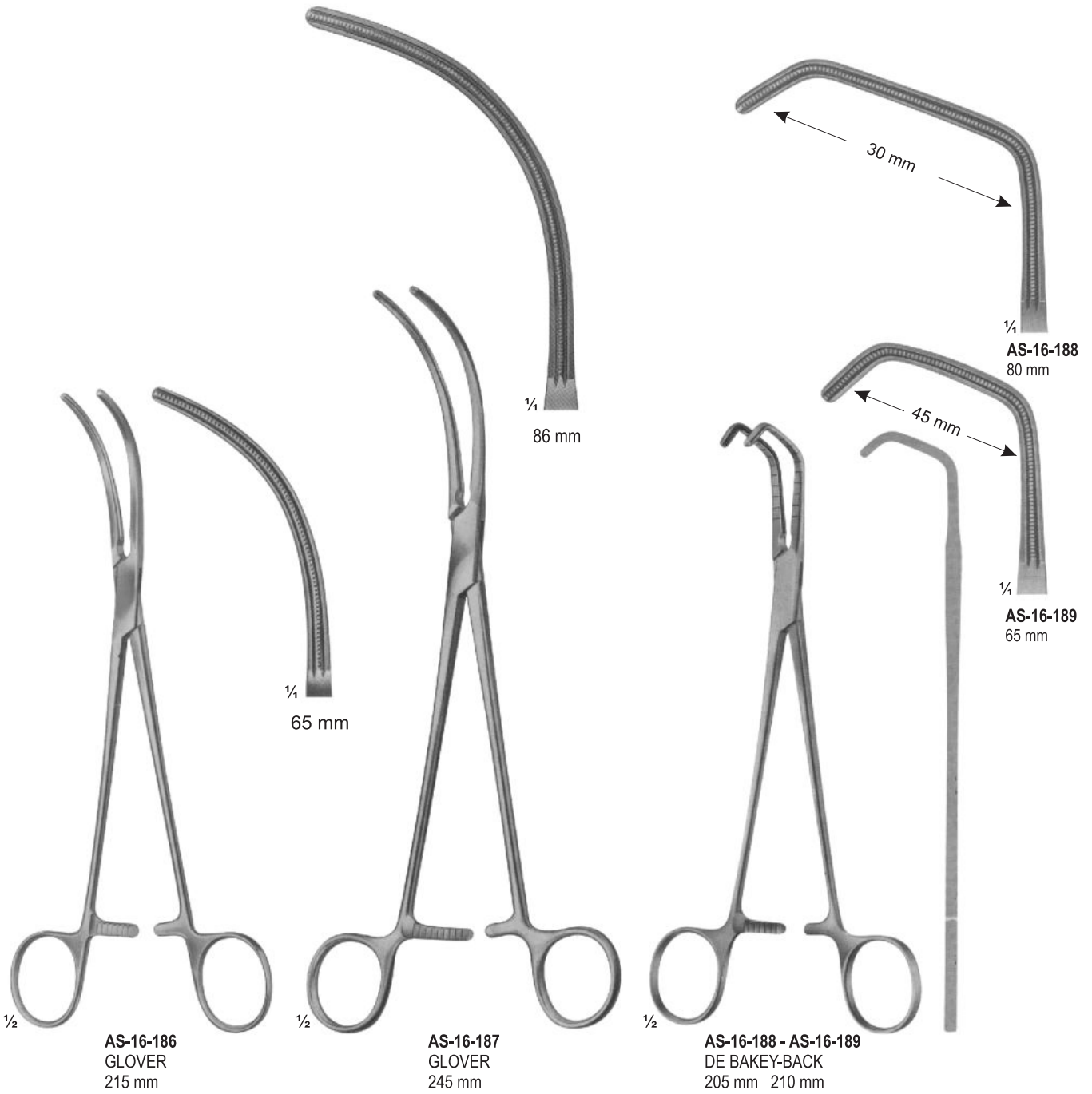

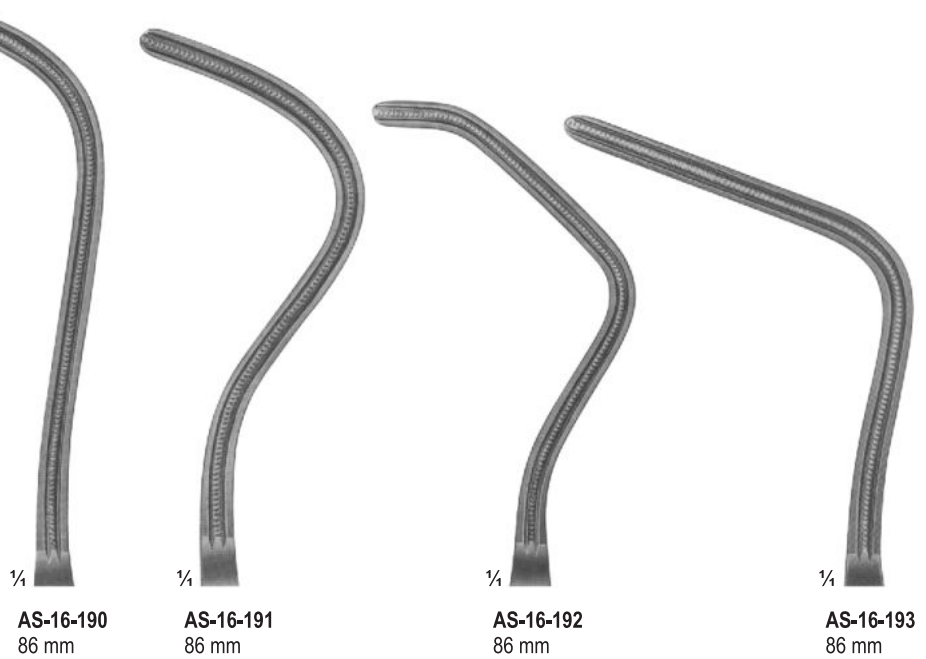

1/4
AS-16-190
86 mm

1/4
AS-16-191
86 mm

1/4
AS-16-192
86 mm

1/4
AS-16-193
86 mm

AS-16-190 - AS-16-193
DE BAKEY-HARKEN
AS-16-190 - 255 mm
AS-16-191 - 245 mm
AS-16-192 - 245 mm
AS-16-193 - 245 mm

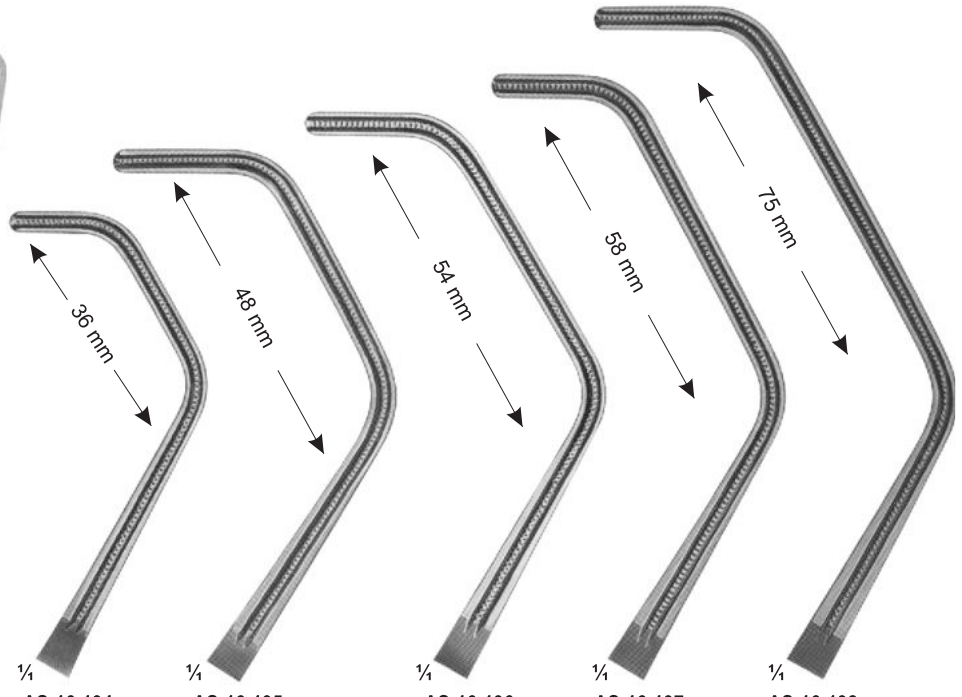

1/2
AS-16-194 - AS-16-198
DE BAKEY
Total Length:
Length of jaws:

1/4
AS-16-194
220 mm
85 mm

1/4
AS-16-195
256 mm
95 mm

1/4
AS-16-196
270 mm
99 mm

1/4
AS-16-197
270 mm
103 mm

1/4
AS-16-198
280 mm
119 mm



DE-BAKEY-KELLY AS-16-199 - AS-16-200
140 mm



AS-16-199
32 mm



AS-16-200
32 mm



PEAN AS-16-201 - AS-16-202
155 mm



AS-16-201
50 mm



AS-16-202
50 mm



AS-16-203 - AS-16-208

DE-BAKEY-PEAN	DE-BAKEY-PEAN
AS-16-203 200 mm	AS-16-206 200 mm
AS-16-204 265 mm	AS-16-207 260 mm
AS-16-205 280 mm	AS-16-208 275 mm



AS-16-203
60 mm

AS-16-204
89 mm

AS-16-205
99 mm

AS-16-206
60 mm

AS-16-207
89 mm

AS-16-208
99 mm

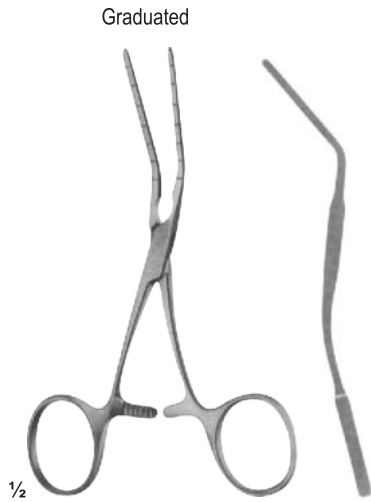

CASTANEDA
AS-16-209 - AS-16-212

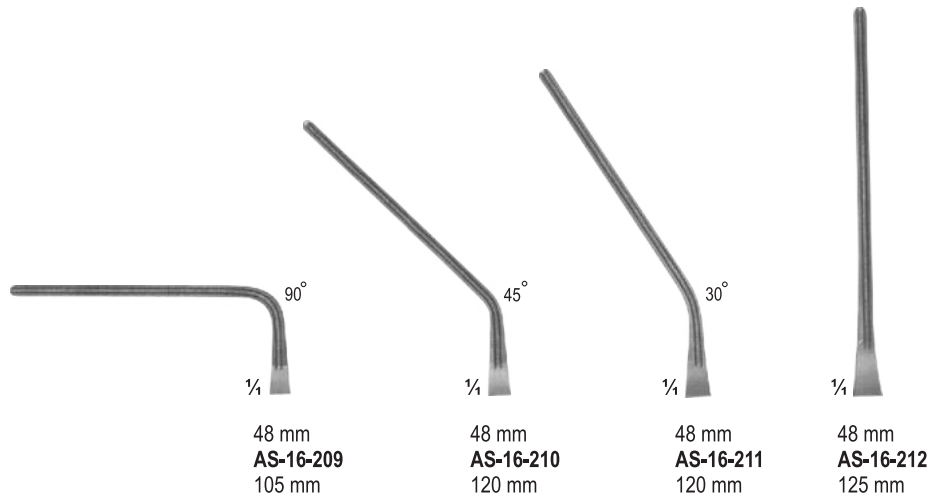

CASTANEDA
AS-16-213 - AS-16-216

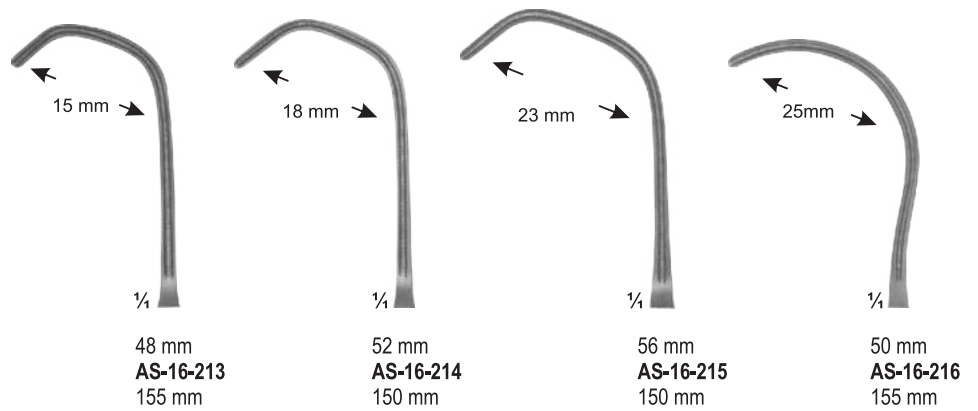

ANASTOMOSIS CLAMPS & VENA-CAVA CLAMPS



ASAMAR
SURGICAL

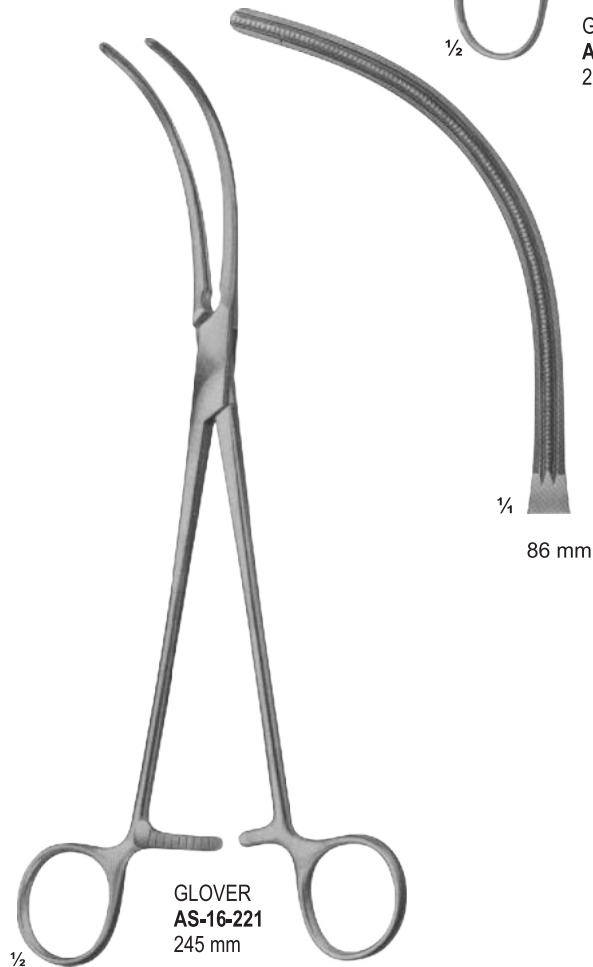
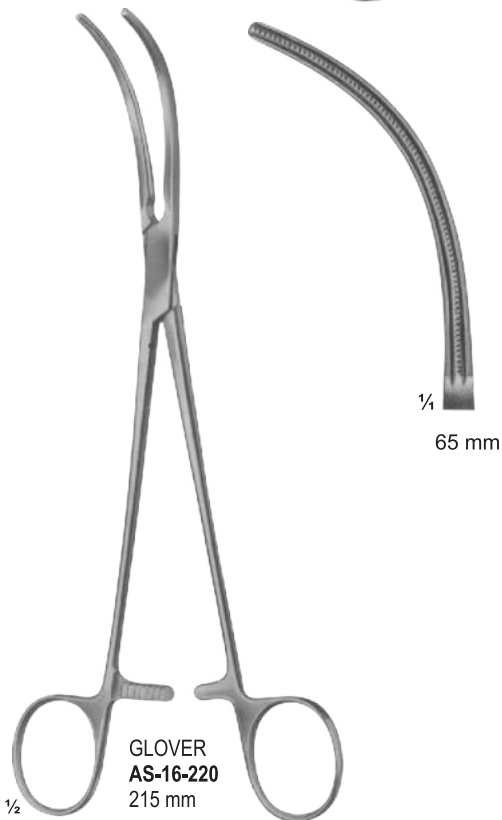
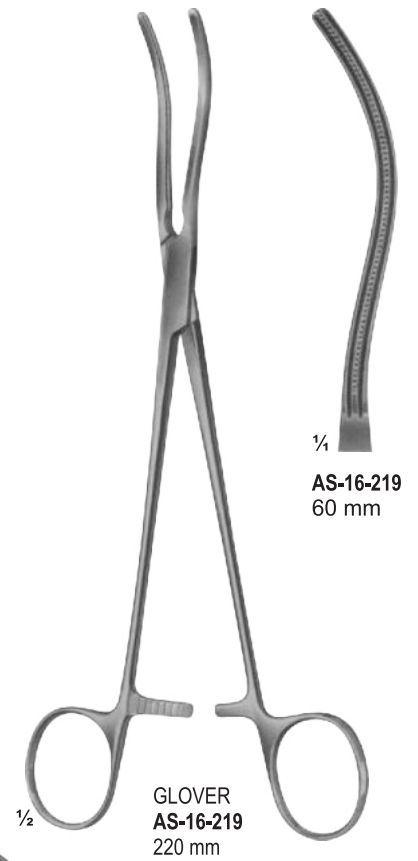
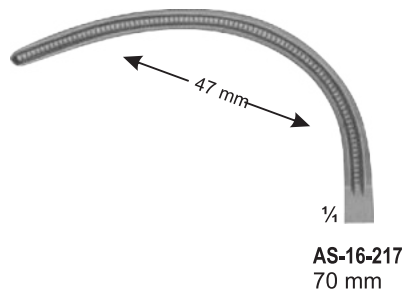
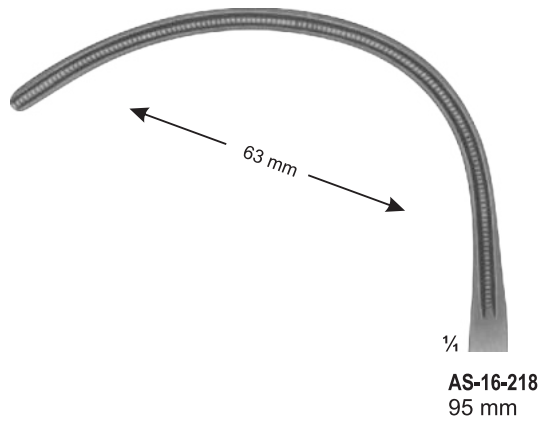



DE BAKEY-BACK
AS-16-222 20.5 cm
AS-16-223 21 cm

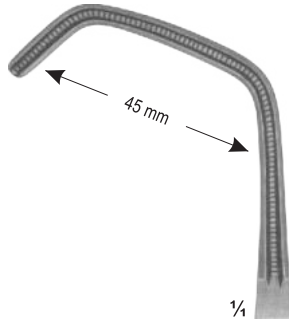

AS-16-222
 65 mm

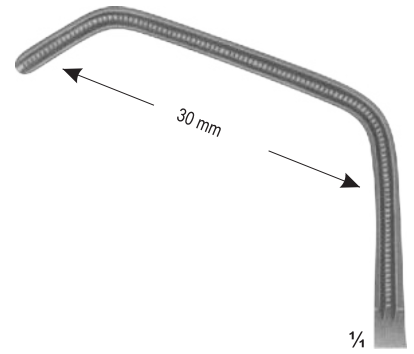

AS-16-223
 80 mm

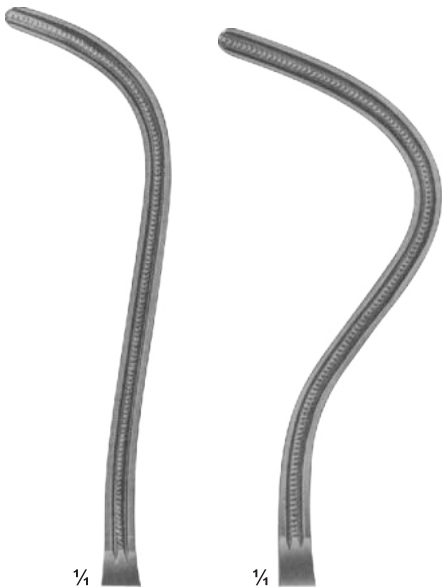

AS-16-224
 86 mm

AS-16-225
 86 mm

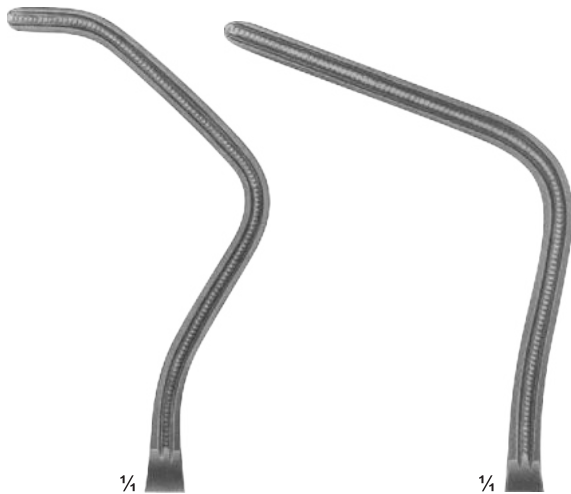

AS-16-226
 86 mm

AS-16-227
 86 mm

DE BAKEY-HARKEN
AS-16-224 25.5 cm
AS-16-225 24.5 cm
AS-16-226 24.5 cm
AS-16-227 24.5 cm



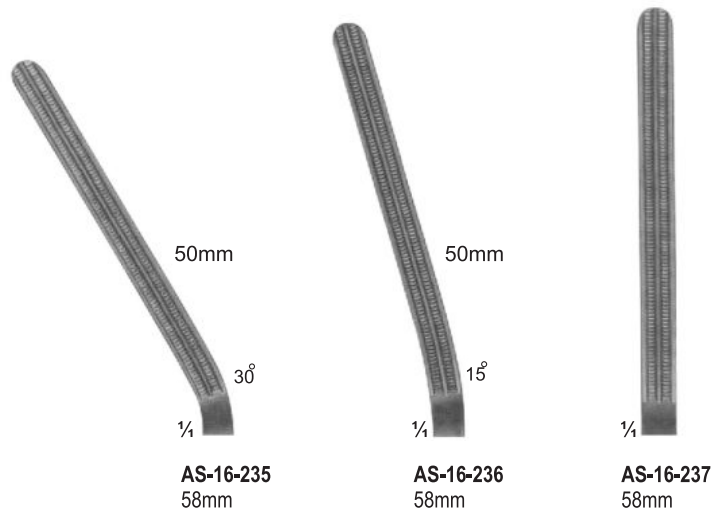
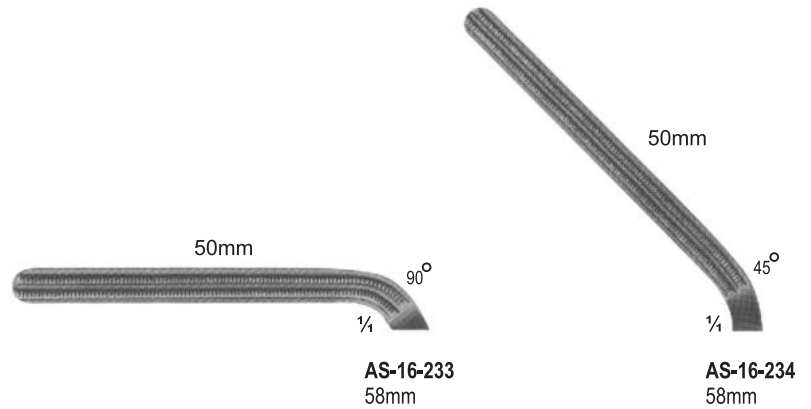
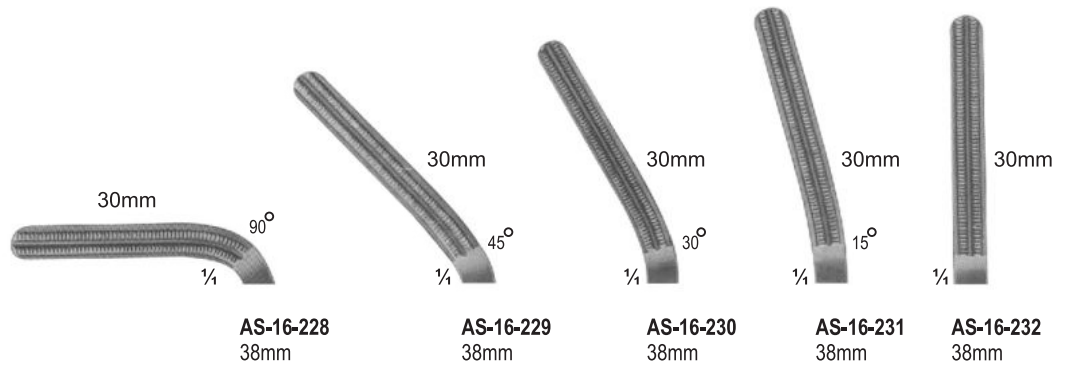

- DARDIK
- AS-16-228 15 cm
 - AS-16-229 15 cm
 - AS-16-230 15 cm
 - AS-16-231 14.5 cm
 - AS-16-232 13 cm
 - AS-16-233 17 cm
 - AS-16-234 17 cm
 - AS-16-235 17 cm
 - AS-16-236 16 cm
 - AS-16-237 13.5 cm



ATRAUMA

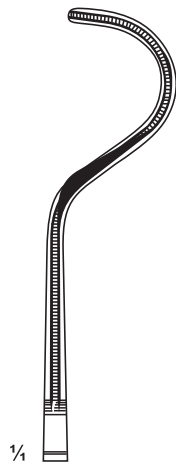
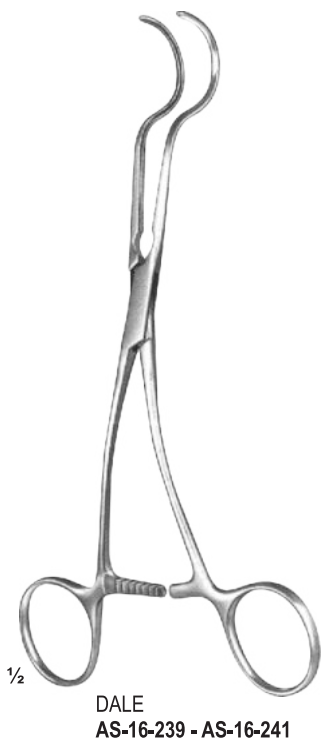
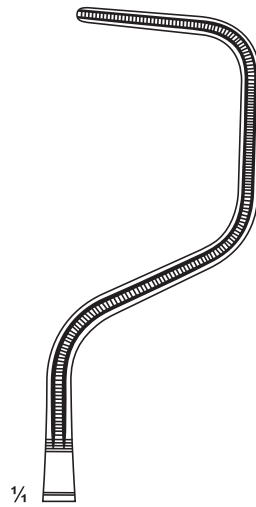
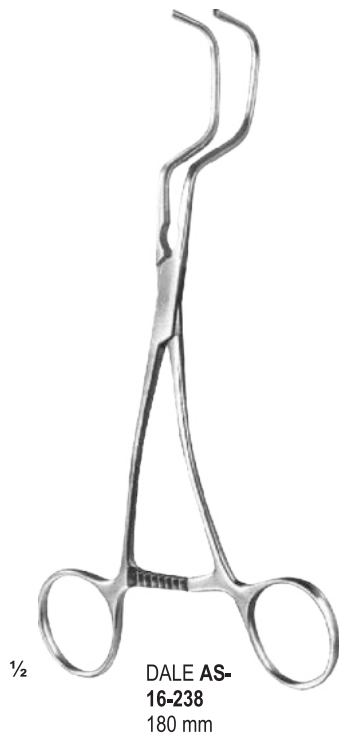

AS-16-239
175 mm

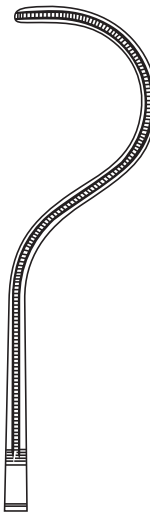

AS-16-240
180 mm

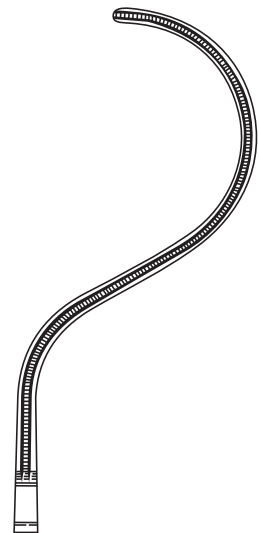

AS-16-241
185 mm



ATRAUMA

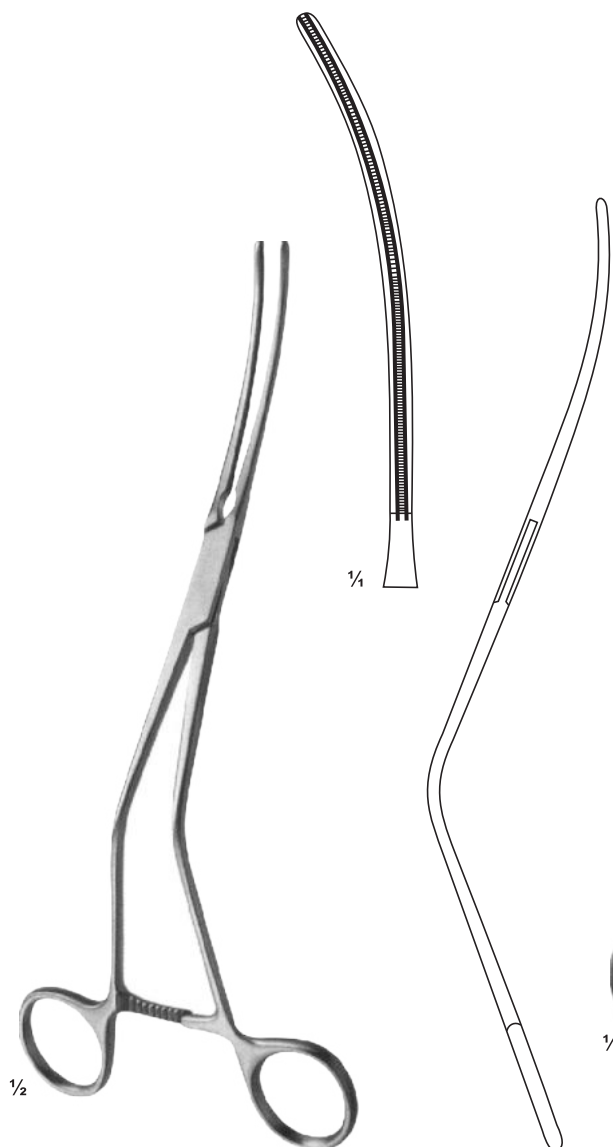

WYLIE
AS-16-242
240 mm

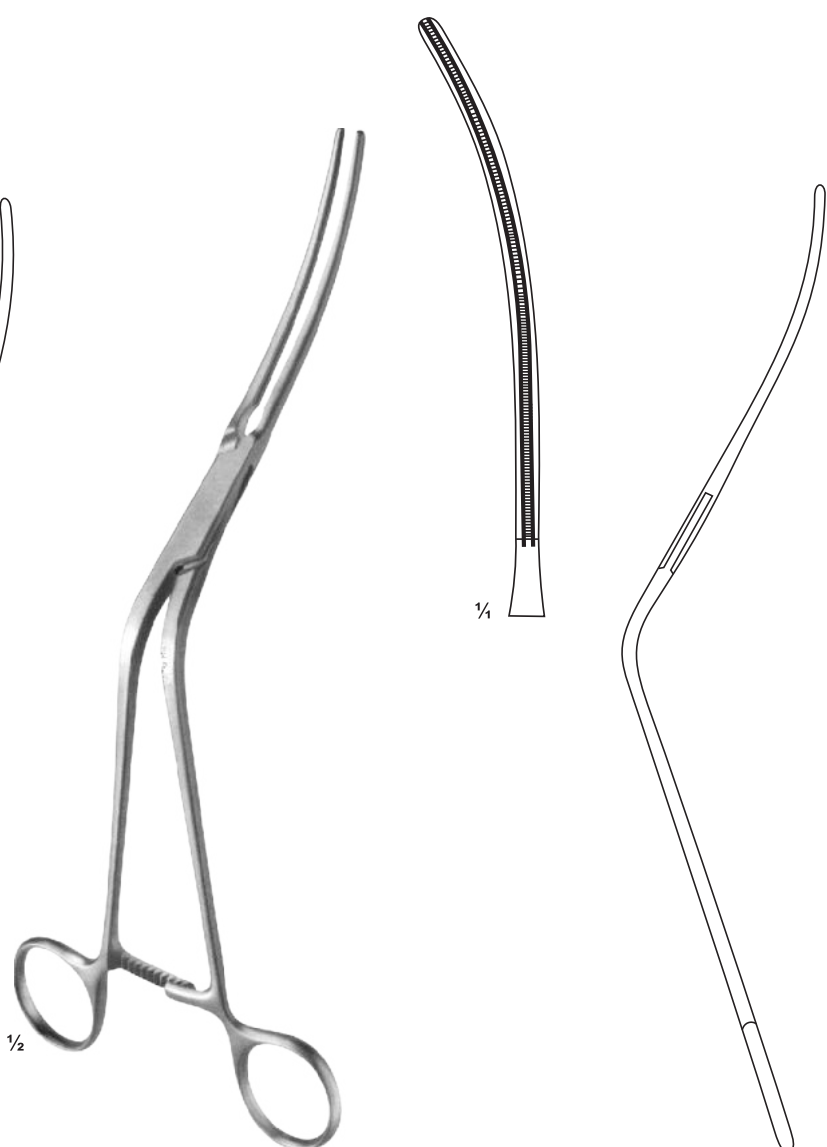

WYLIE
AS-16-243
270 mm

VENA-CAVA CLAMPS

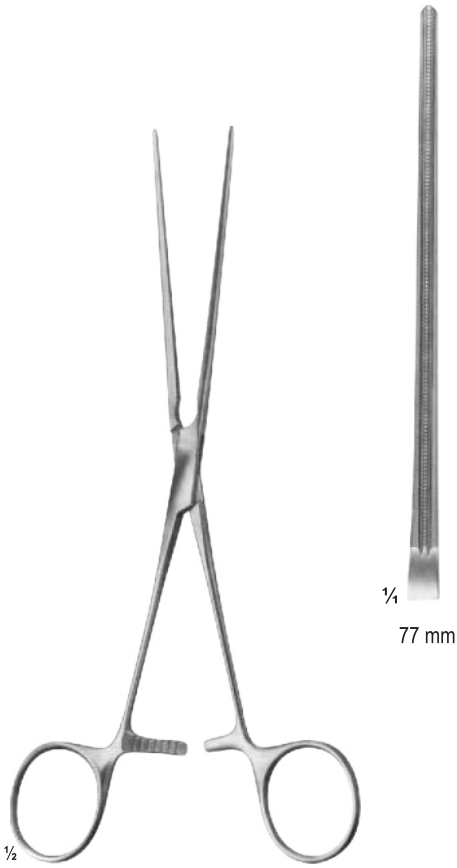

LELAND-JONES
AS-16-244
195 mm

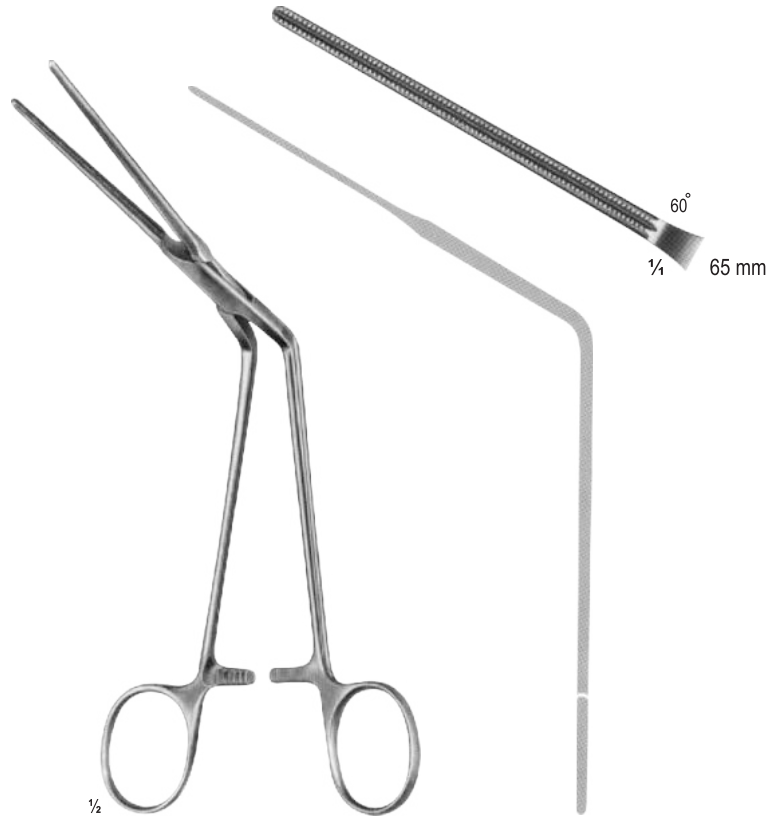

DE BAKEY
AS-16-245
200 mm
Liac Clamp



COOLEY
AS-16-246 120 mm
AS-16-247 125 mm
AS-16-248 125 mm

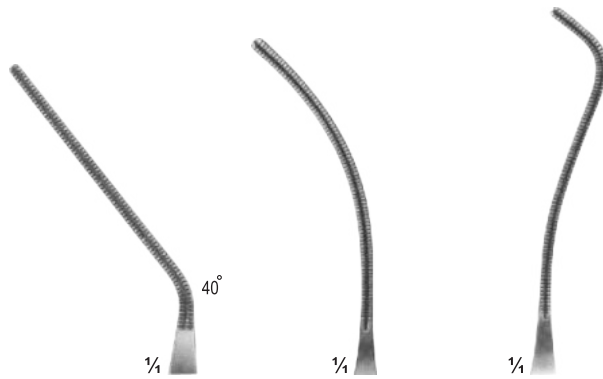

AS-16-246
50 mm

AS-16-247
50 mm

AS-16-248
52 mm

ANEURYSM CLAMPS

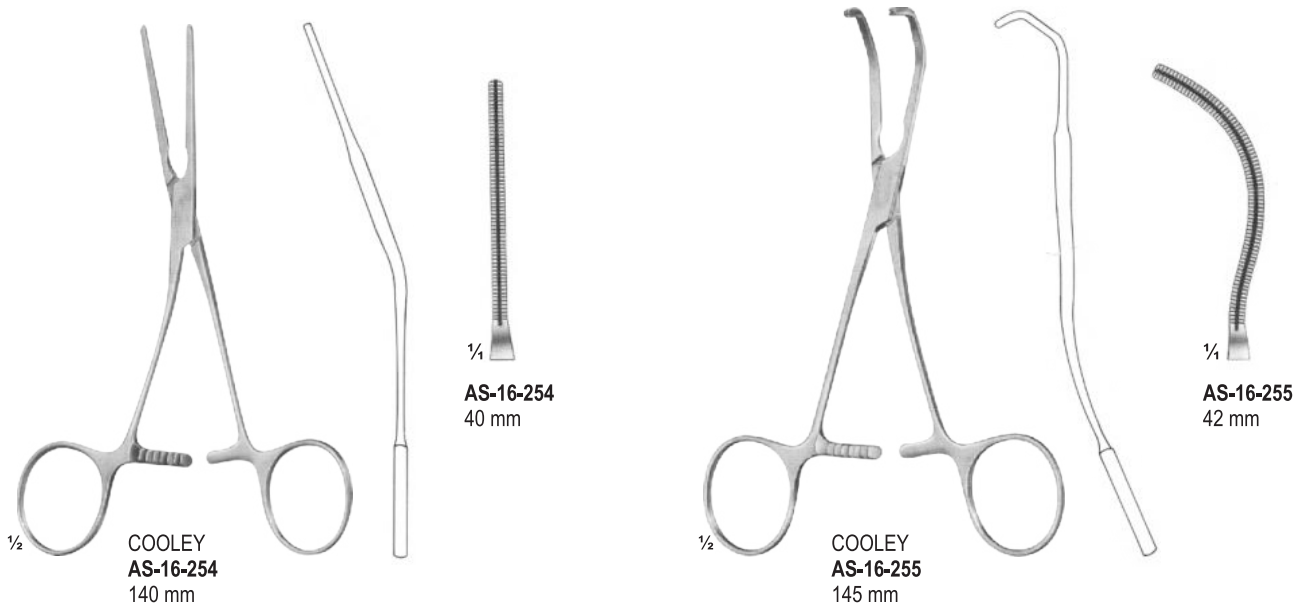
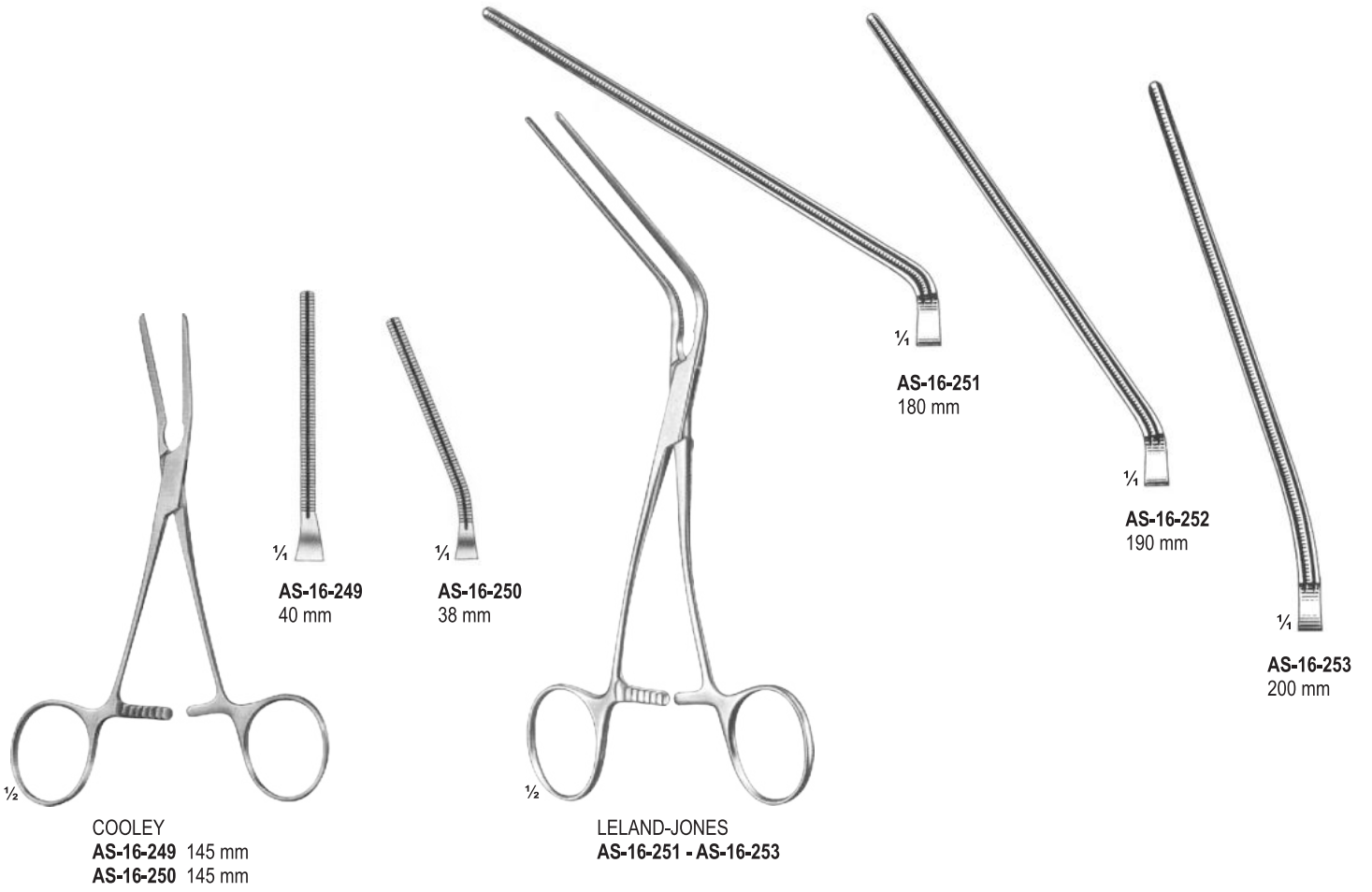



$\frac{1}{2}$
AS-16-256 - AS-16-258
 DE BAKEY-SATINSKY
 235 mm, 240 mm, 245 mm

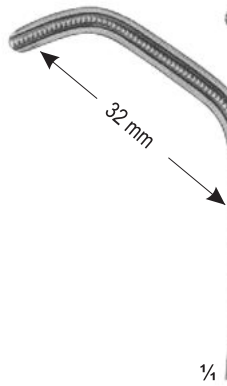

$\frac{1}{4}$
AS-16-256
 68 mm

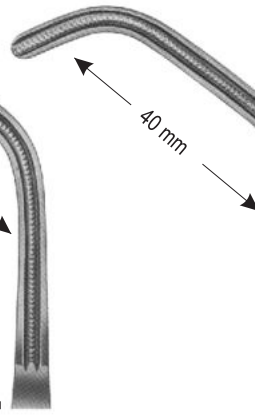

$\frac{1}{4}$
AS-16-257
 76 mm

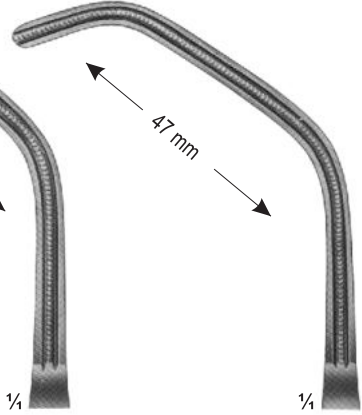

$\frac{1}{4}$
AS-16-258
 84 mm

VASCULAR CLAMPS



$\frac{1}{2}$
AS-16-259 - AS-16-260
 DE BAKEY
 170 mm, 165 mm



$\frac{1}{4}$
AS-16-259
 50 mm



$\frac{1}{4}$
AS-16-260
 50 mm



$\frac{1}{2}$
AS-16-261
 DE BAKEY
 165 mm

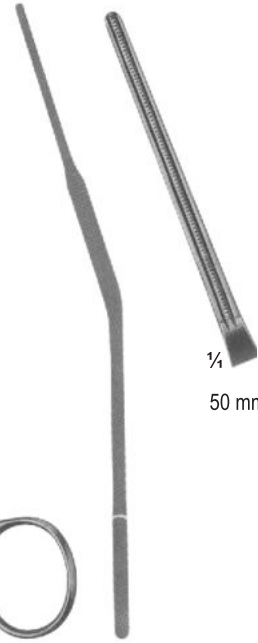

$\frac{1}{4}$
 50 mm

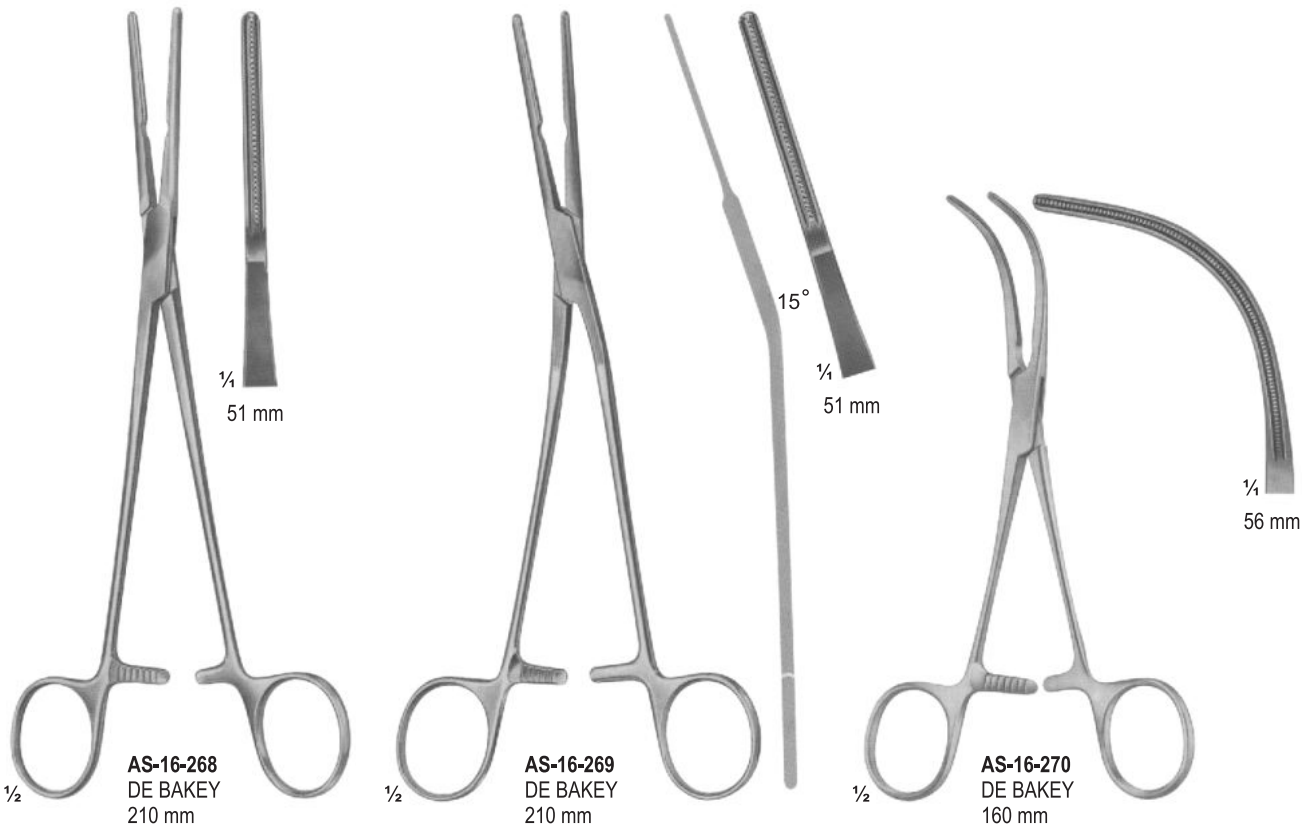
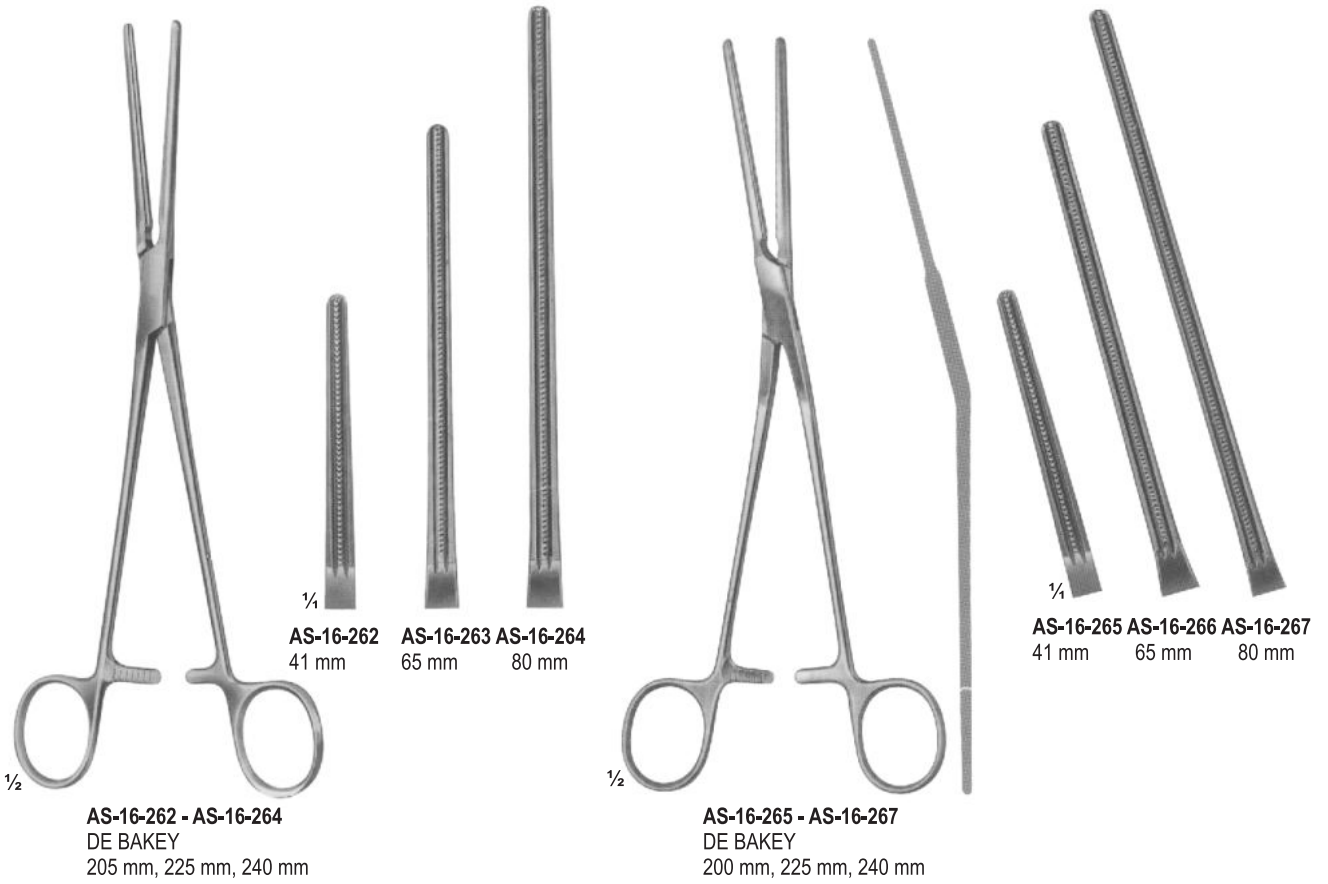

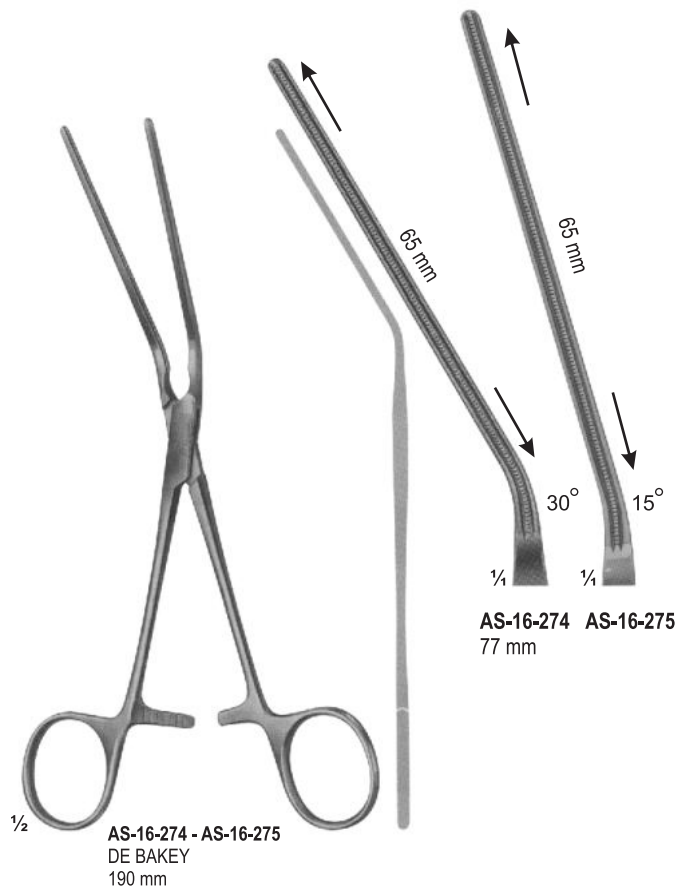
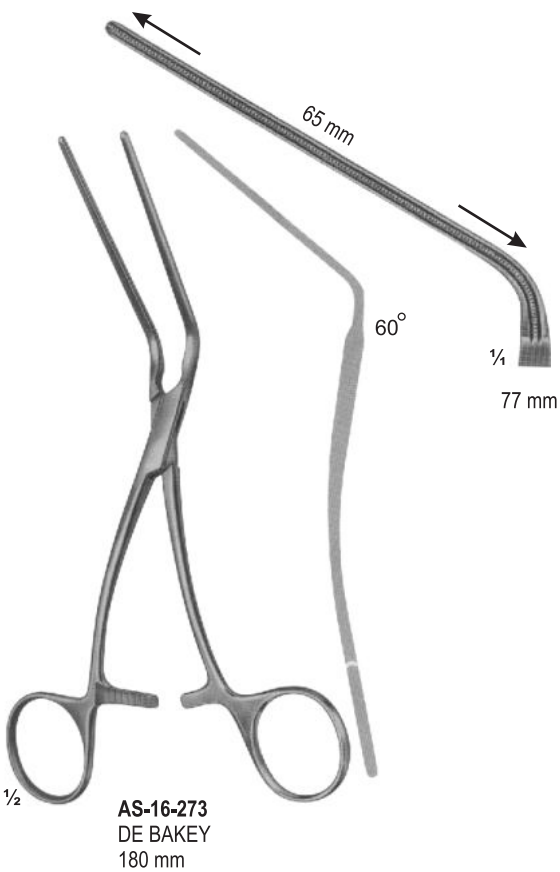
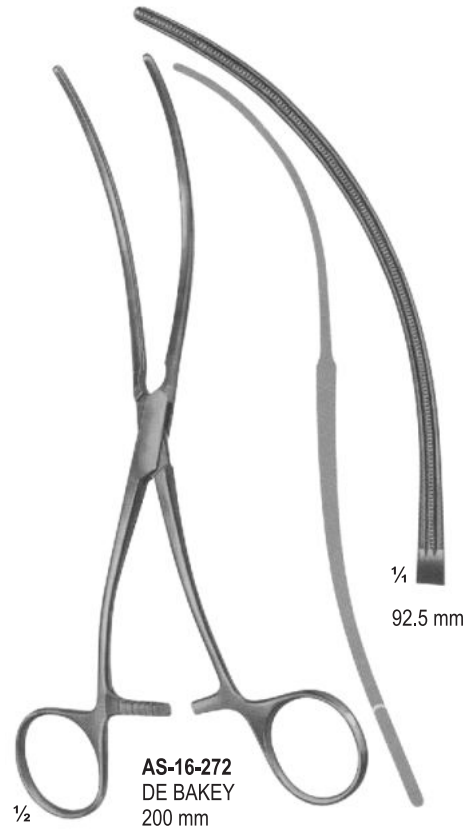
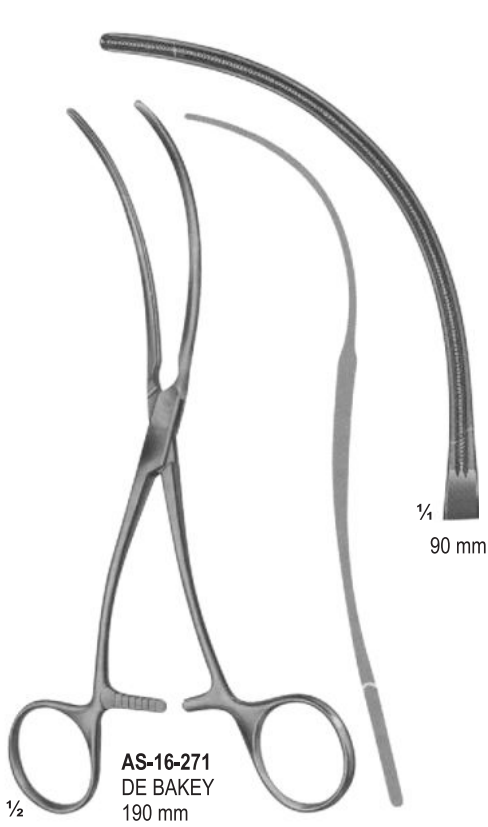

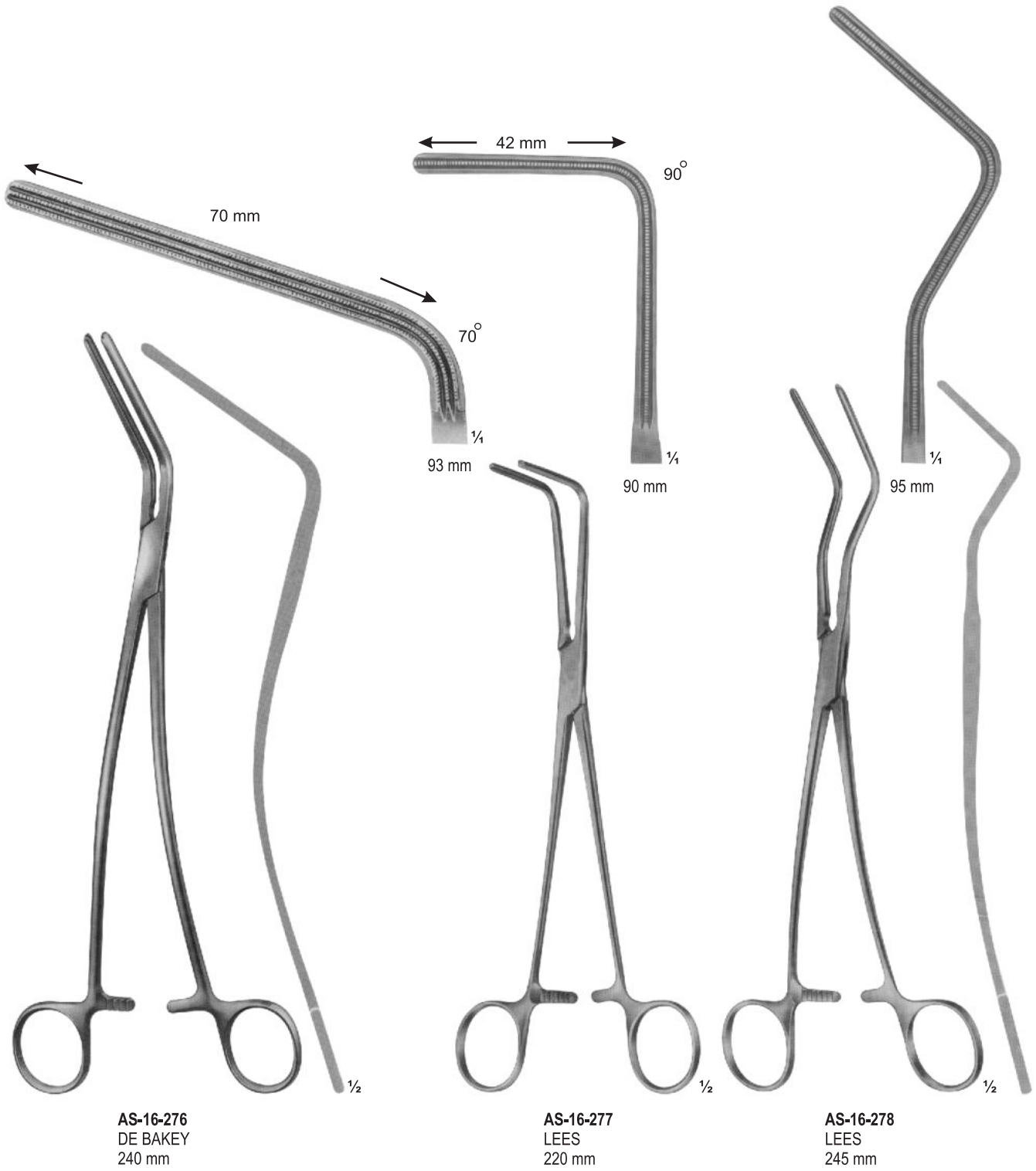

AS-16-276
DE BAKEY
240 mm

AS-16-277
LEES
220 mm

AS-16-278
LEES
245 mm

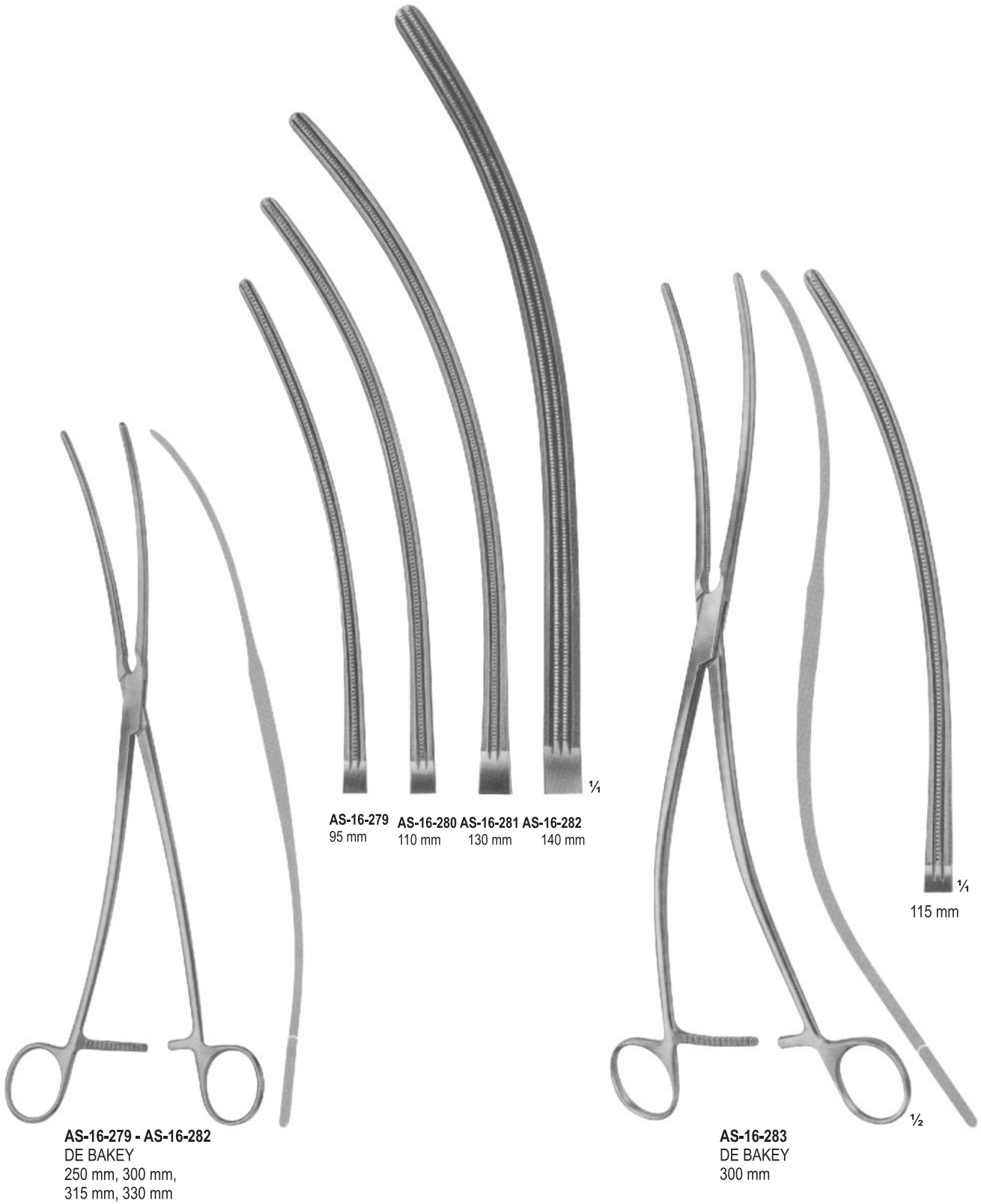

AS-16-279 95 mm AS-16-280 110 mm AS-16-281 130 mm AS-16-282 140 mm

115 mm

AS-16-279 - AS-16-282
DE BAKEY
250 mm, 300 mm,
315 mm, 330 mm

AS-16-283
DE BAKEY
300 mm

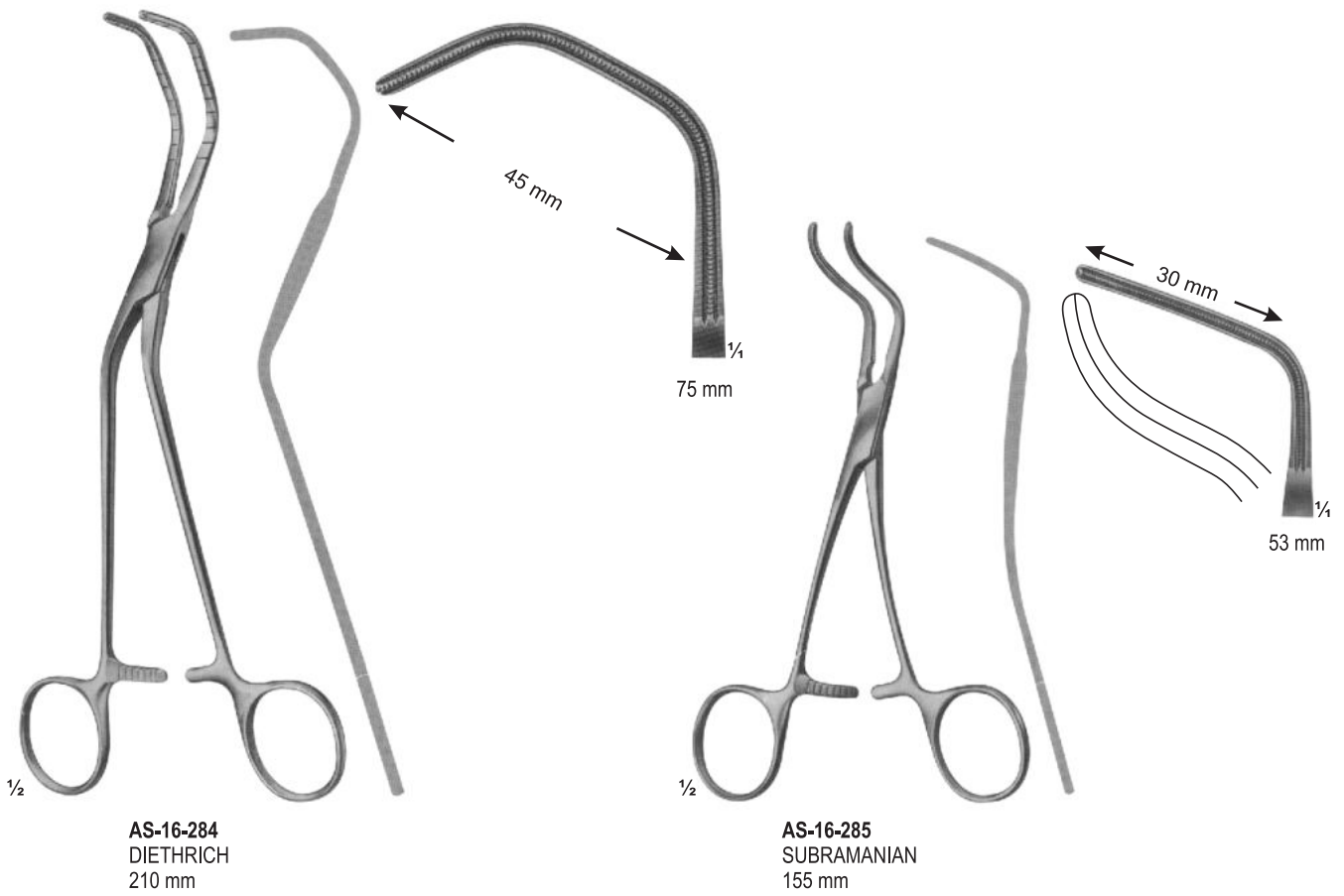

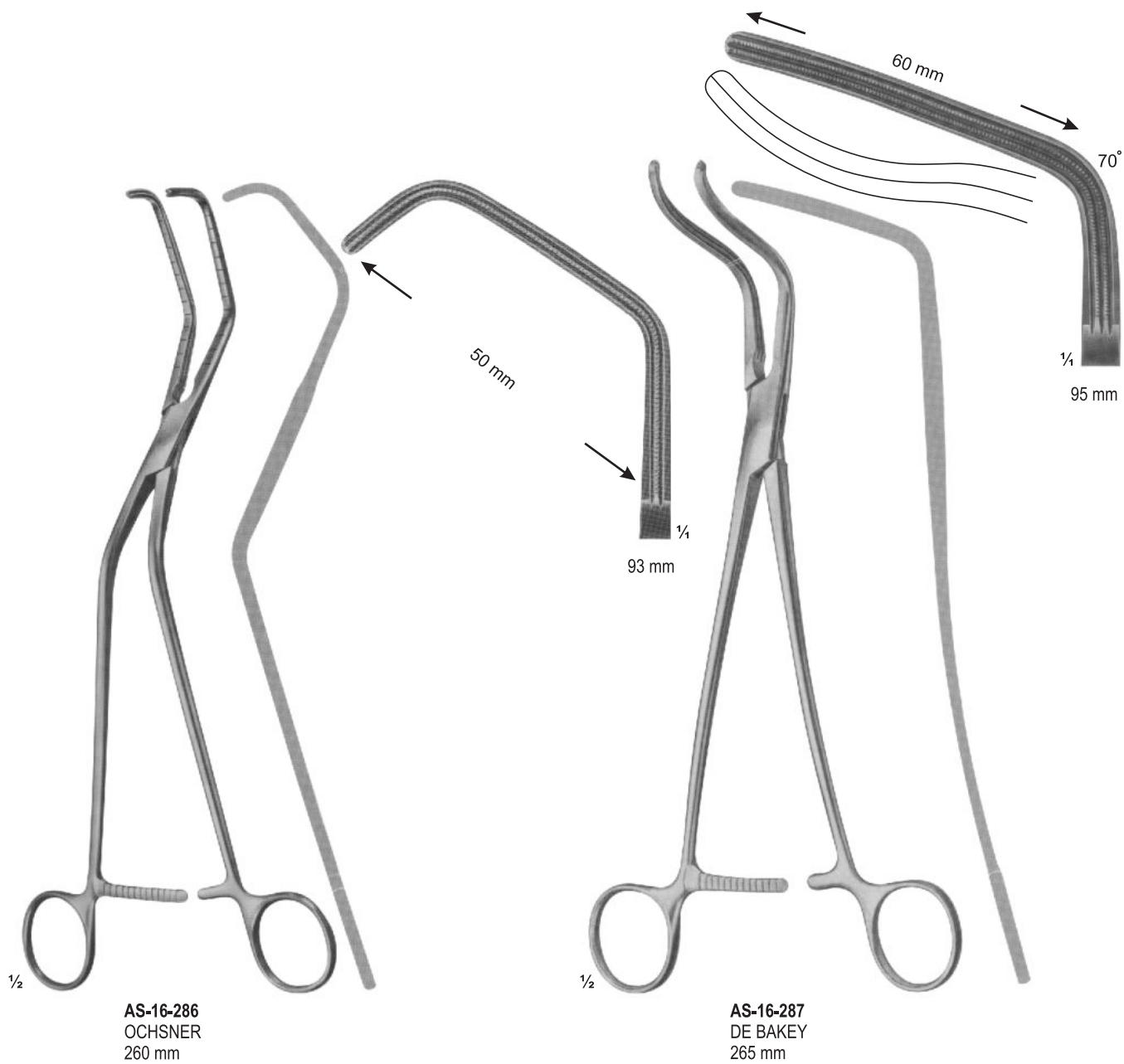

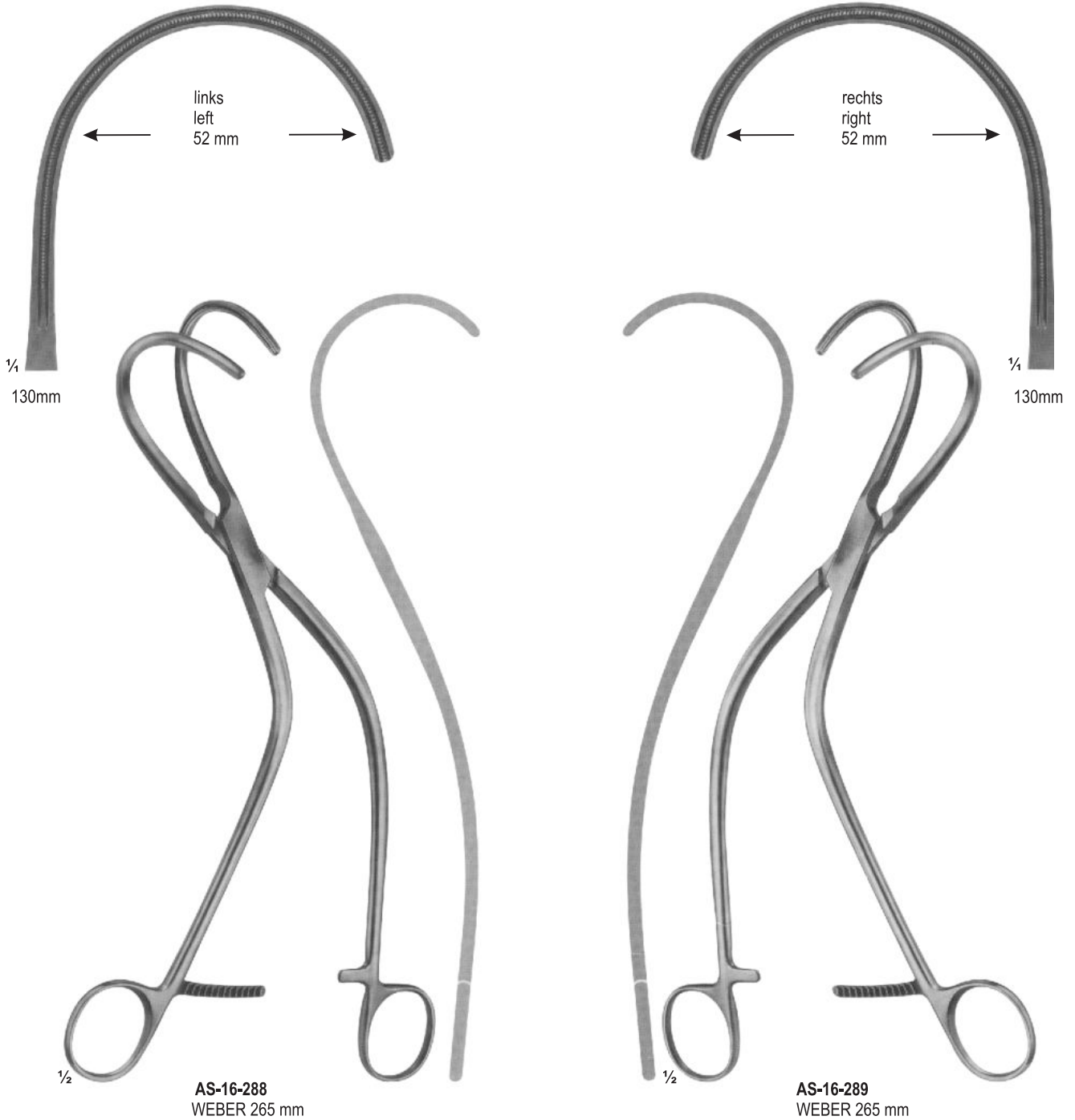



AS-16-290 - AS-16-293
DE BAKEY

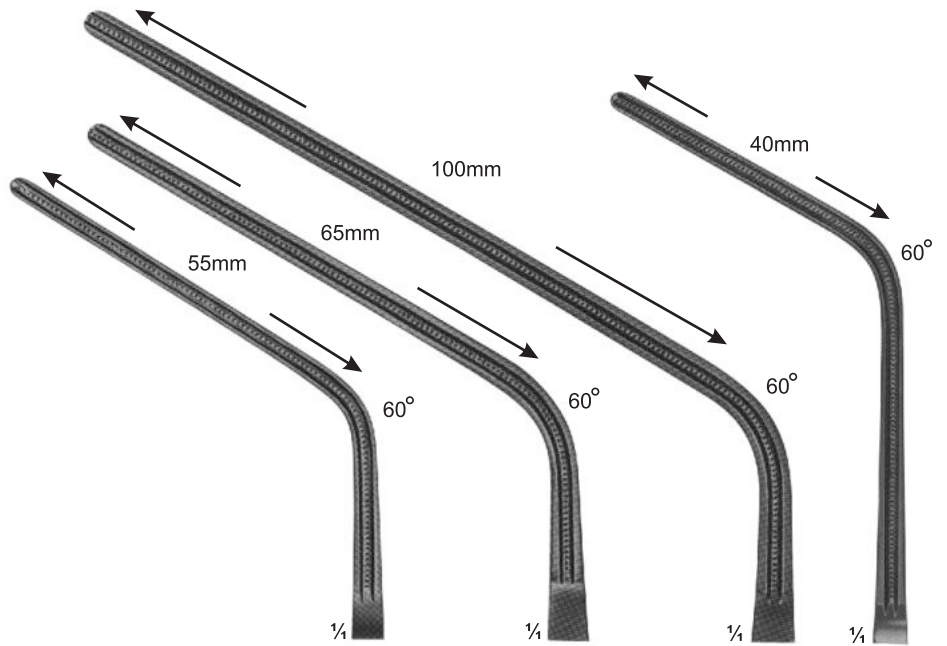

	AS-16-290	AS-16-291	AS-16-292	AS-16-293
Total Length:	230 mm	280 mm	305 mm	240 mm
Length of jaws:	85 mm	100 mm	135 mm	93 mm



AS-16-294 - AS-16-297
DE BAKEY

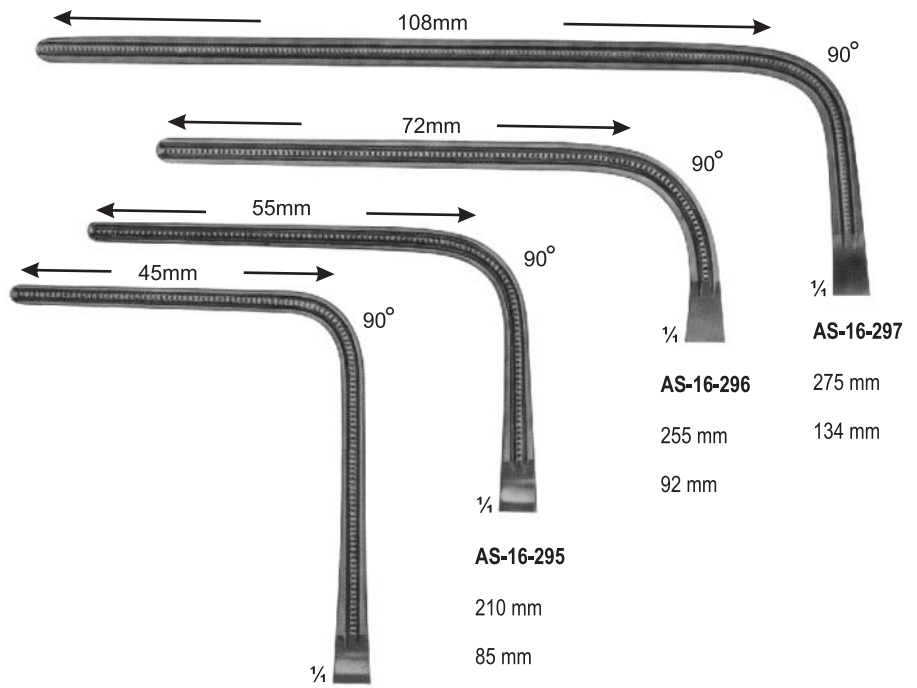

	AS-16-294	AS-16-295	AS-16-296	AS-16-297
Total Length:	225 mm	210 mm	255 mm	275 mm
Length of jaws:	85 mm	92 mm	134 mm	134 mm

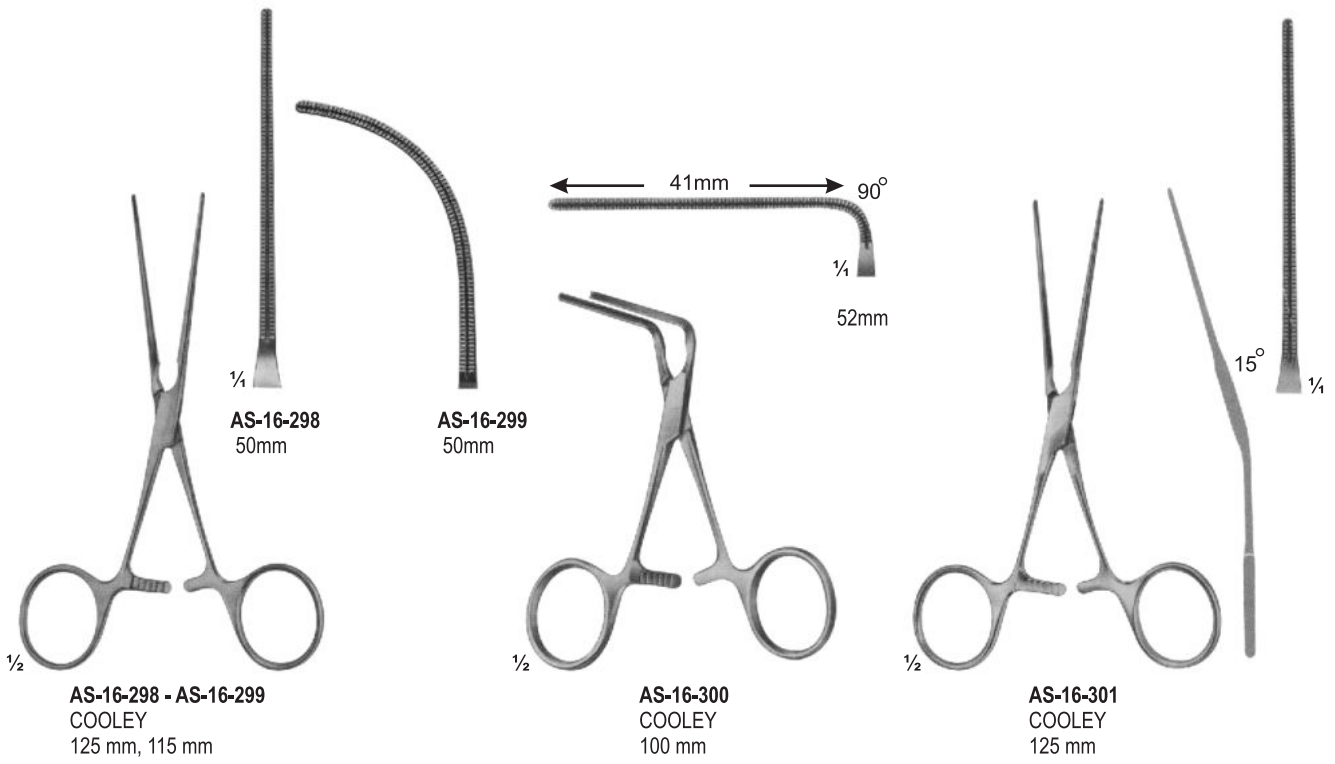

ANASTOMOSIS CLAMPS, PEDIATRIC PATTERNS

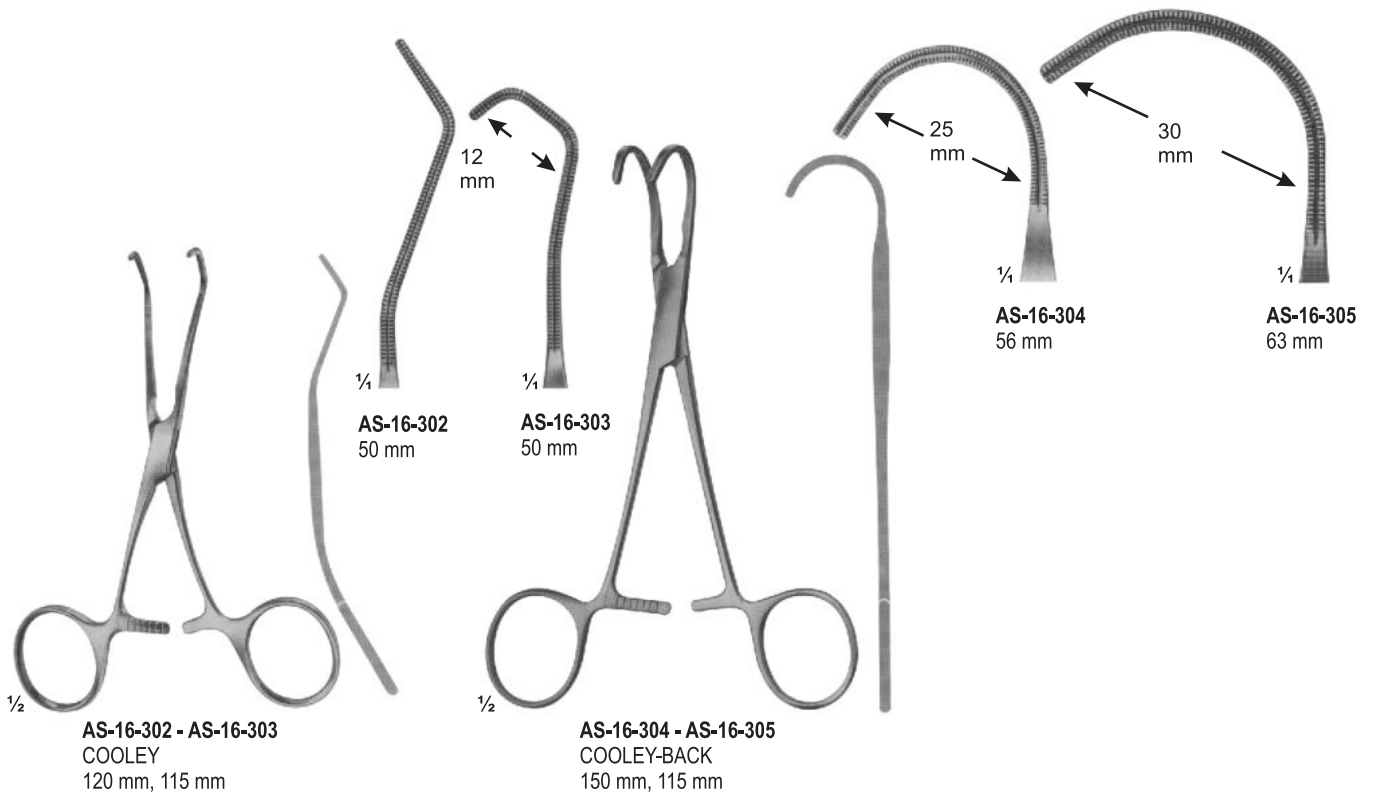

ANASTOMOSIS CLAMPS, PEDIATRIC PATTERNS

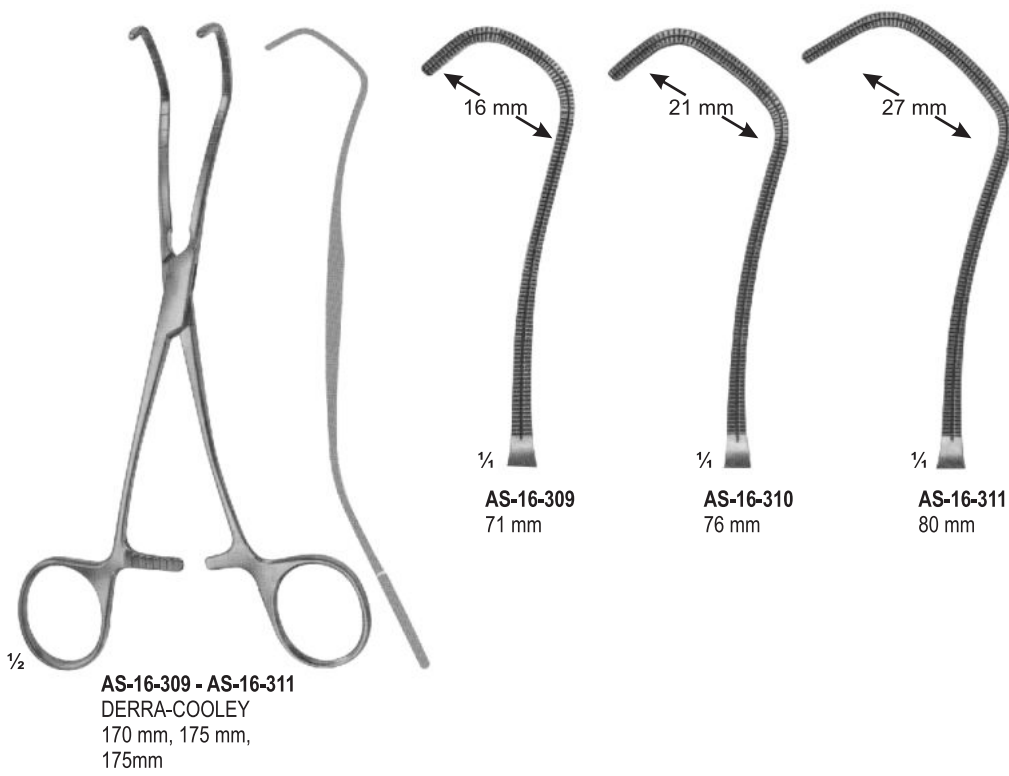
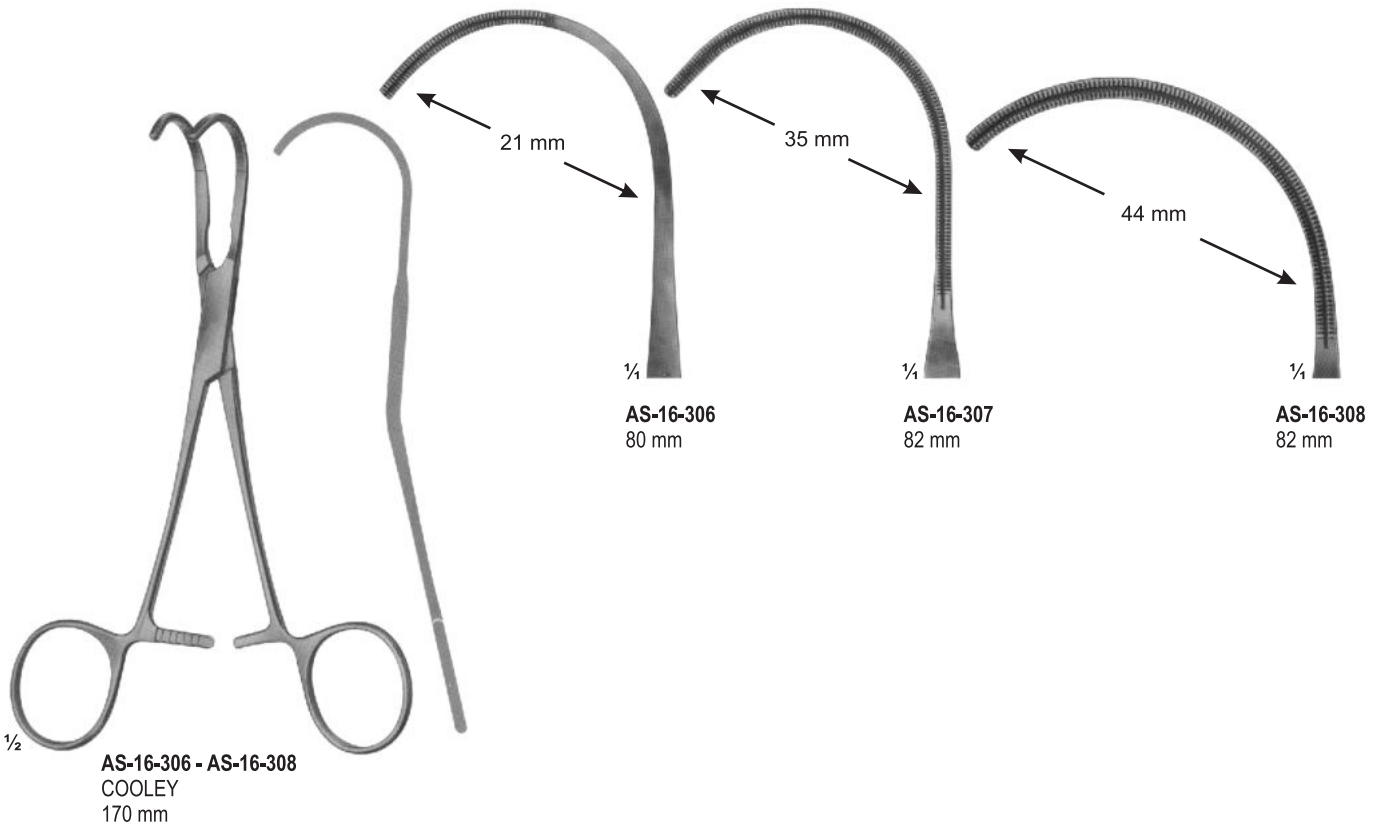

AORTA-ANASTOMOSIS CLAMPS

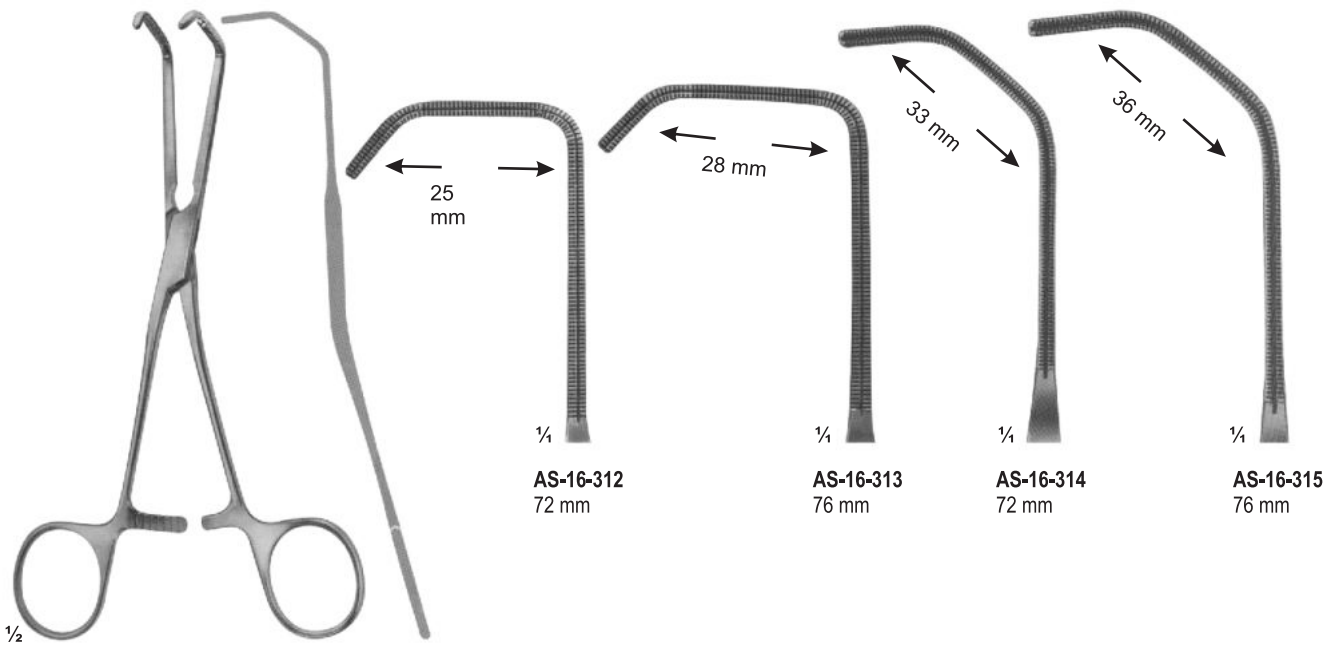

AS-16-312 - AS-16-315
 COOLEY
 165 mm, 165 mm
 175 mm, 180 mm

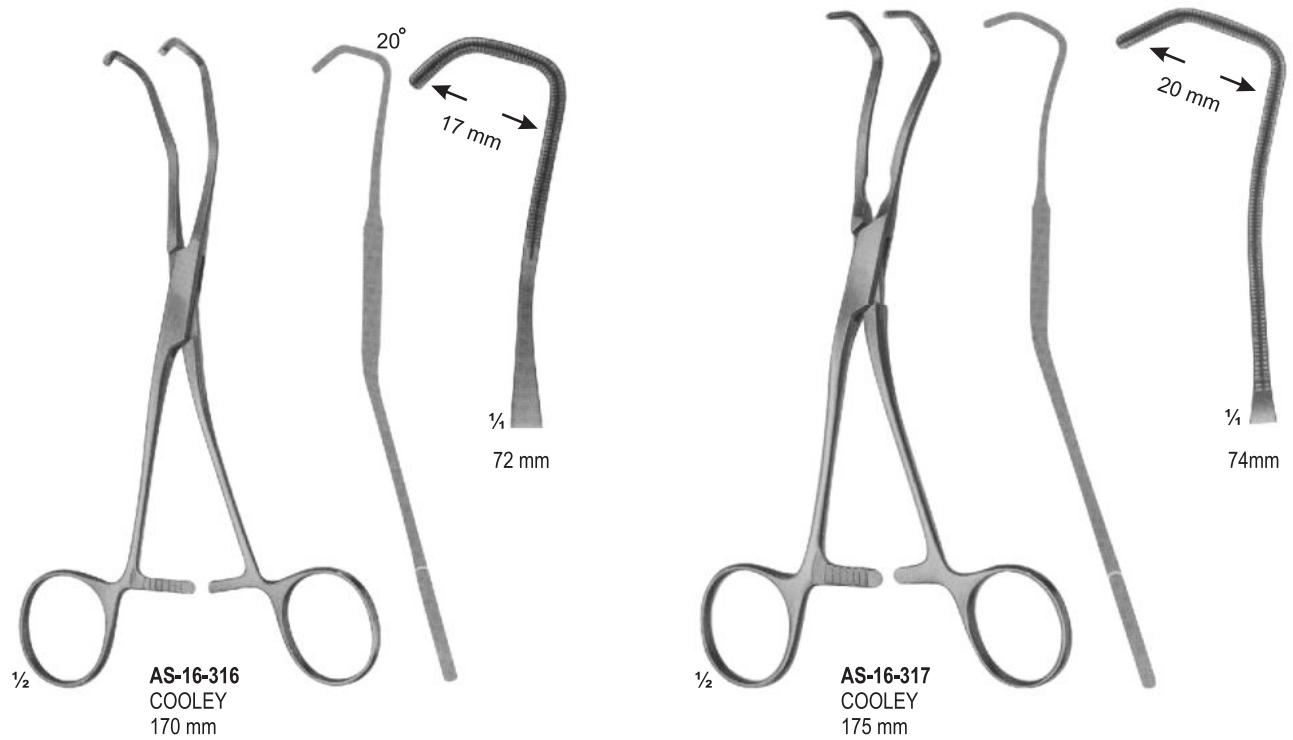

AS-16-316
 COOLEY
 170 mm

AS-16-317
 COOLEY
 175 mm

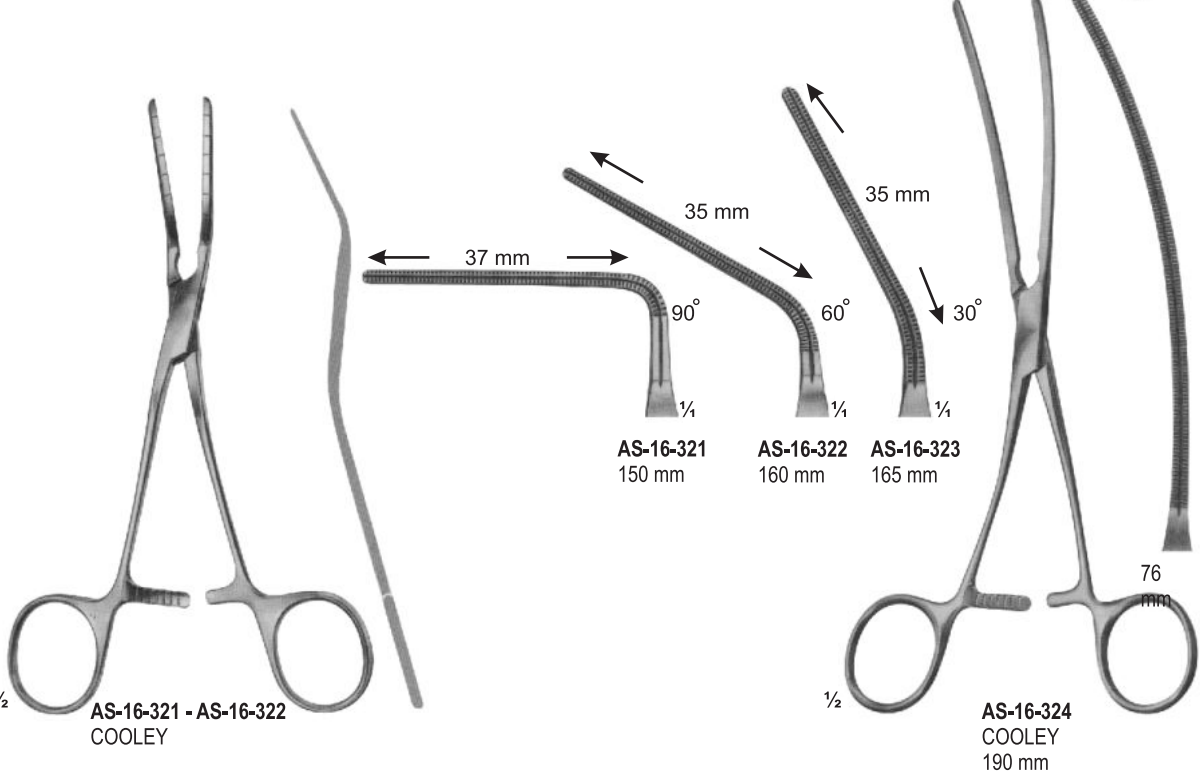
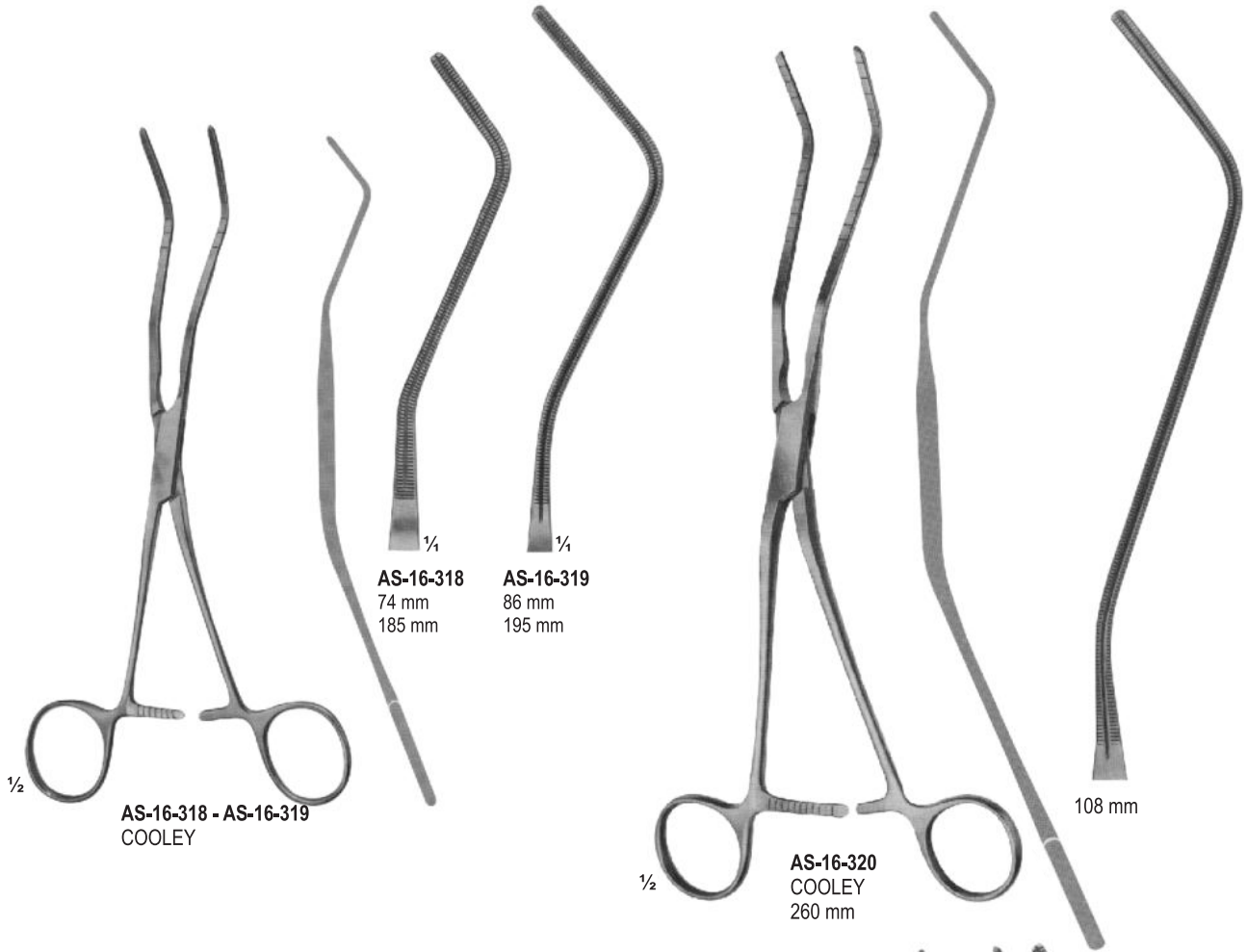

AORTA-ANASTOMOSIS CLAMPS

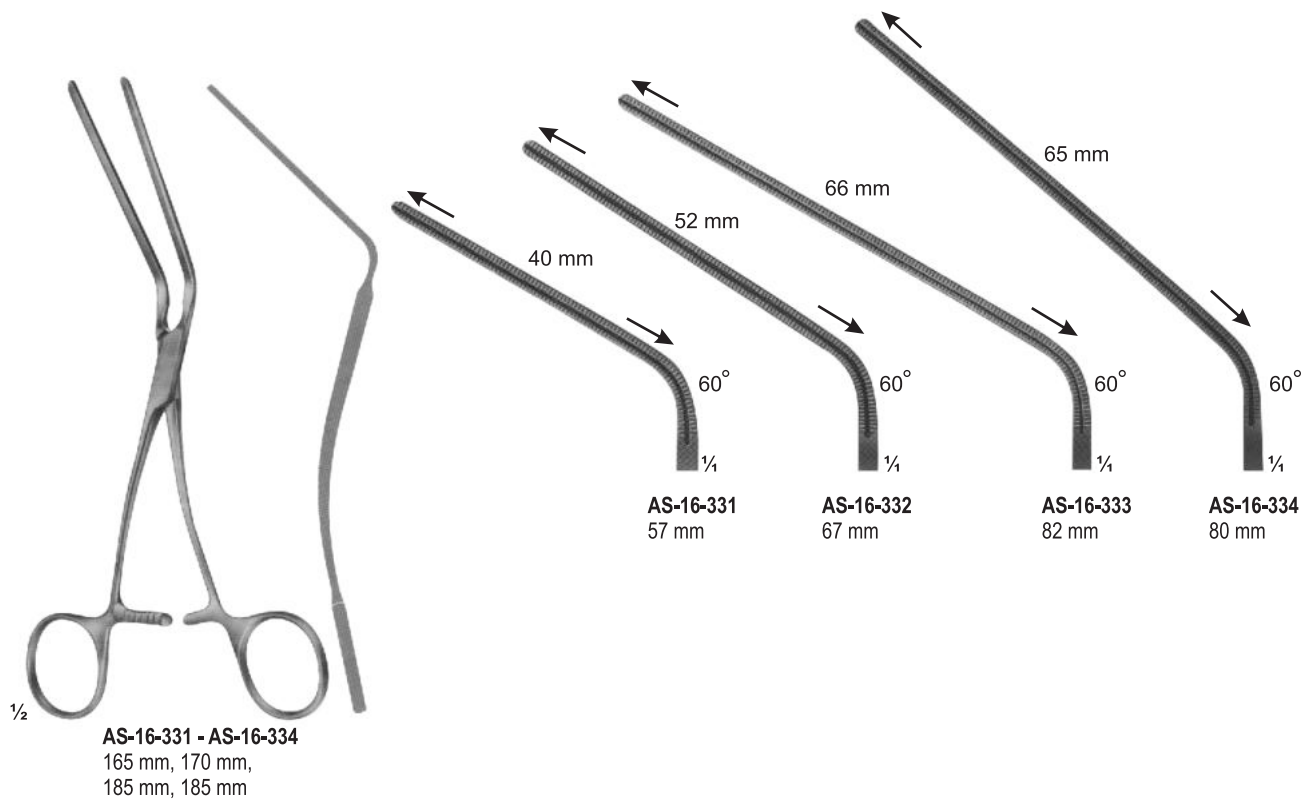
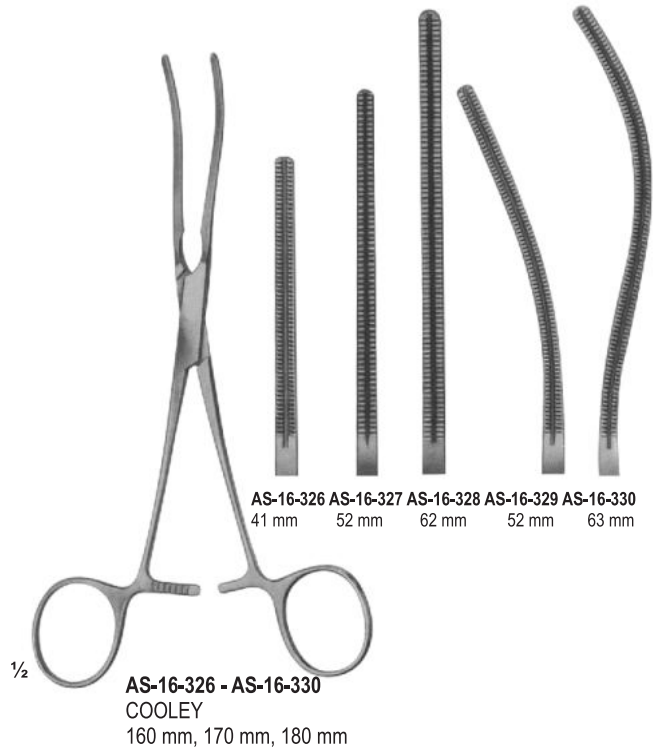
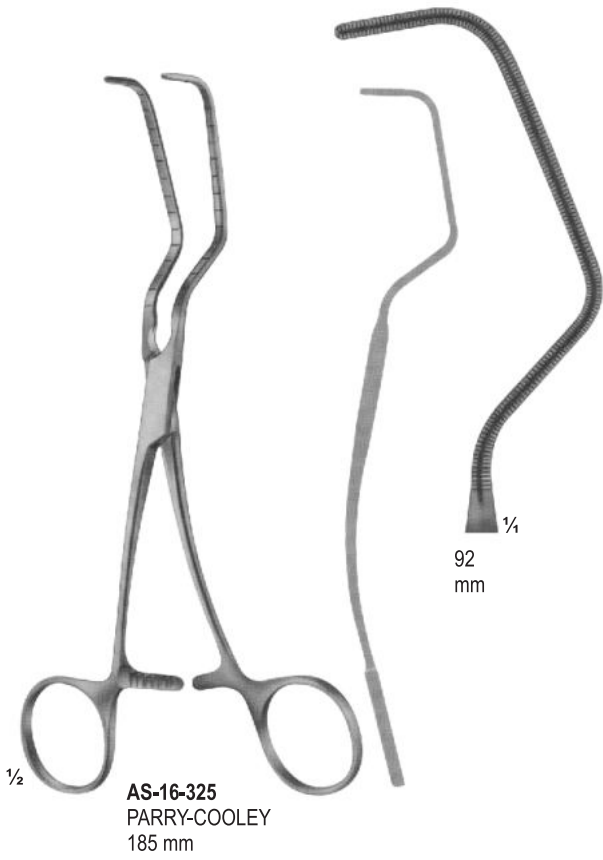



$\frac{1}{2}$ DARDIK
AS-16-335 150 mm
AS-16-336 150 mm
AS-16-337 150 mm
AS-16-338 145 mm
AS-16-339 130 mm

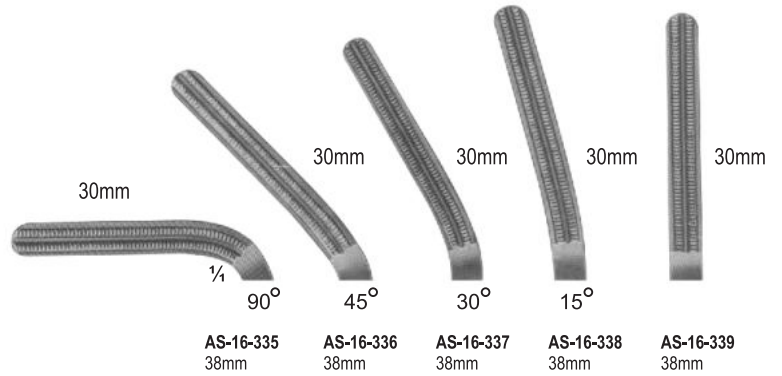

$\frac{1}{2}$ DARDIK
AS-16-335 170 mm
AS-16-336 170 mm
AS-16-337 170 mm
AS-16-338 160 mm
AS-16-339 135 mm

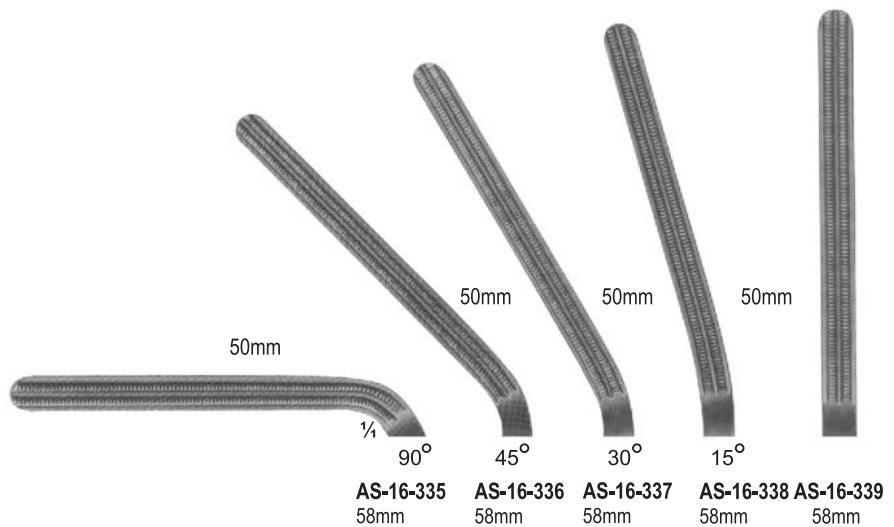

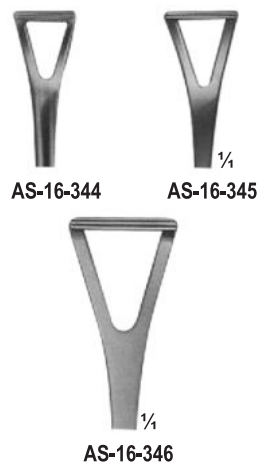
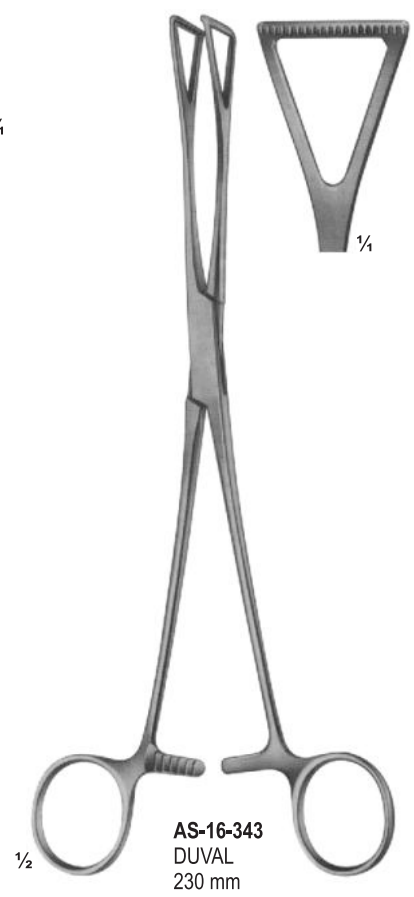

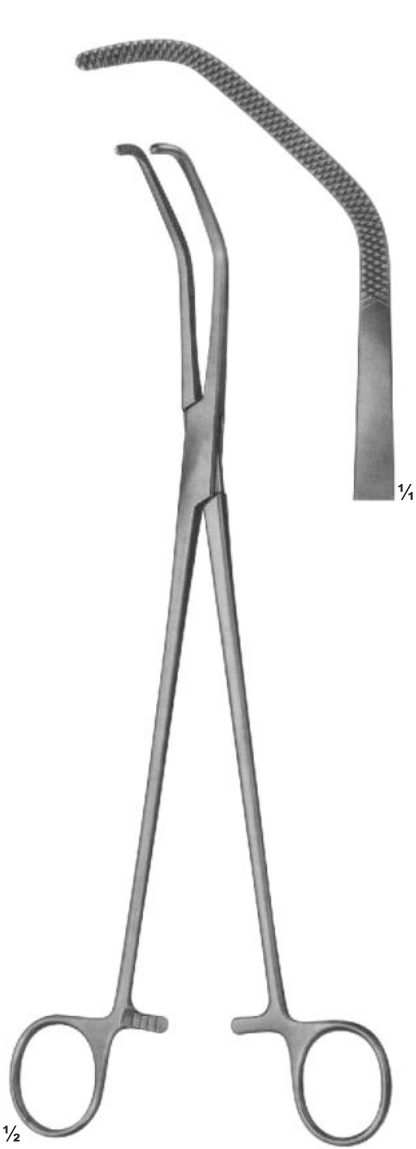

AS-16-348
SATINSKY
265 mm



AS-16-349
SATINSKY
265 mm

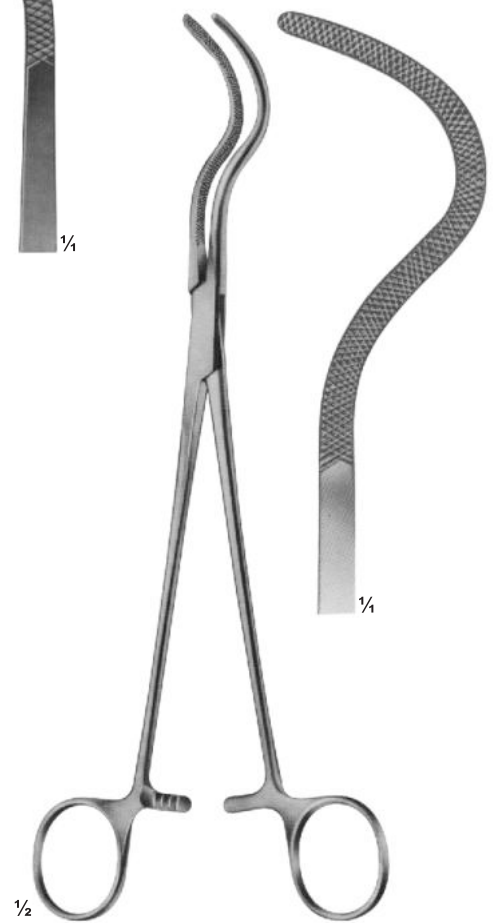

AS-16-350
HARKEN
240 mm

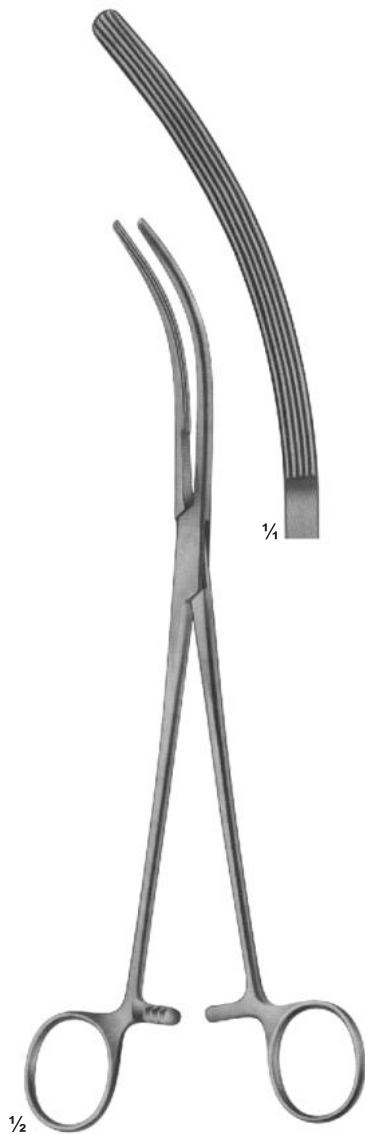

AS-16-351
CRAFOORD-SELLORS
240 mm

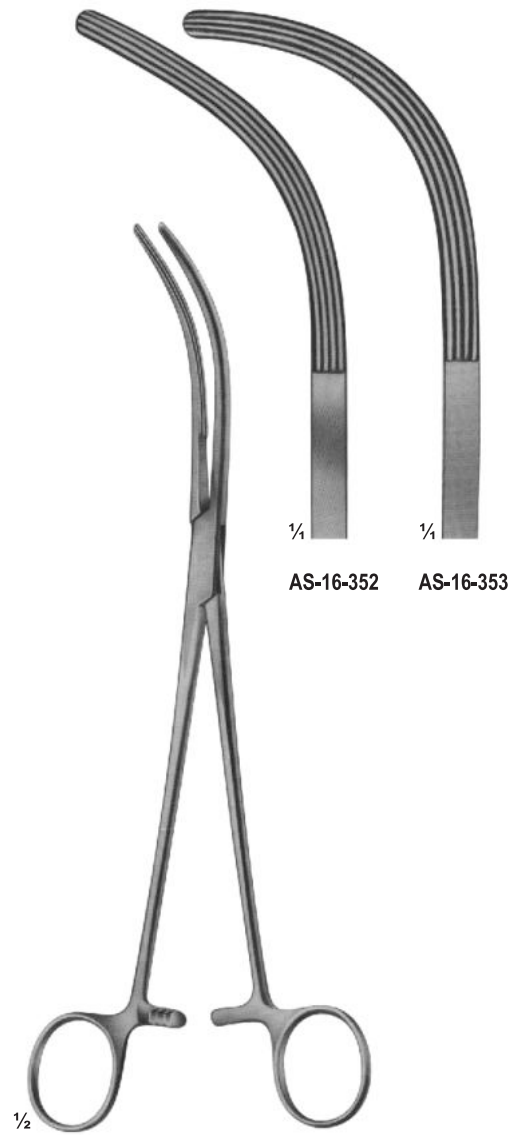

AS-16-352 - AS-16-353
CRAFOORD
240 mm



AS-16-354
PRICE THOMAS
225 mm



AS-16-355
jaws with pins

AS-16-356
jaws with pins

AS-16-355 - AS-16-356
PRICE THOMAS
225 mm

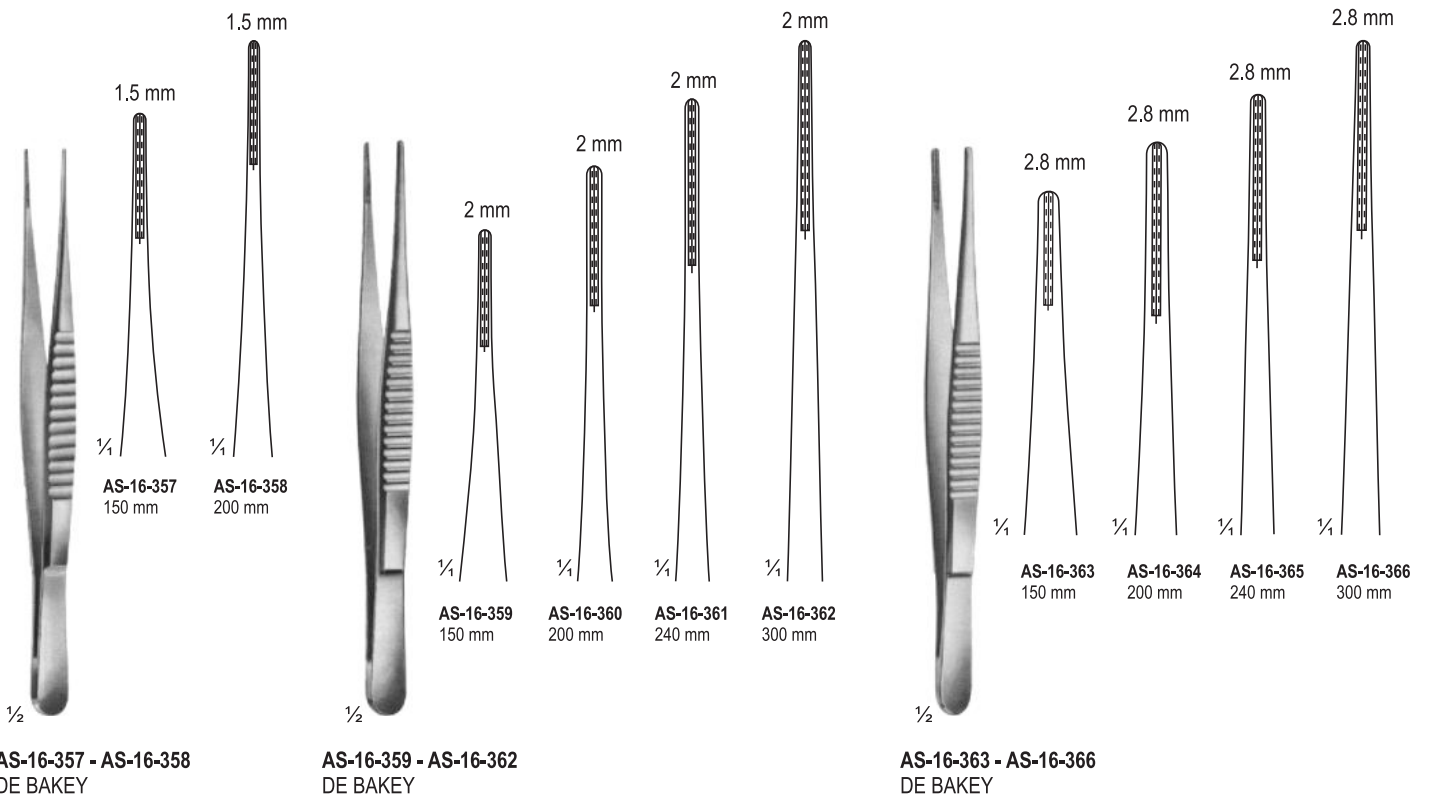

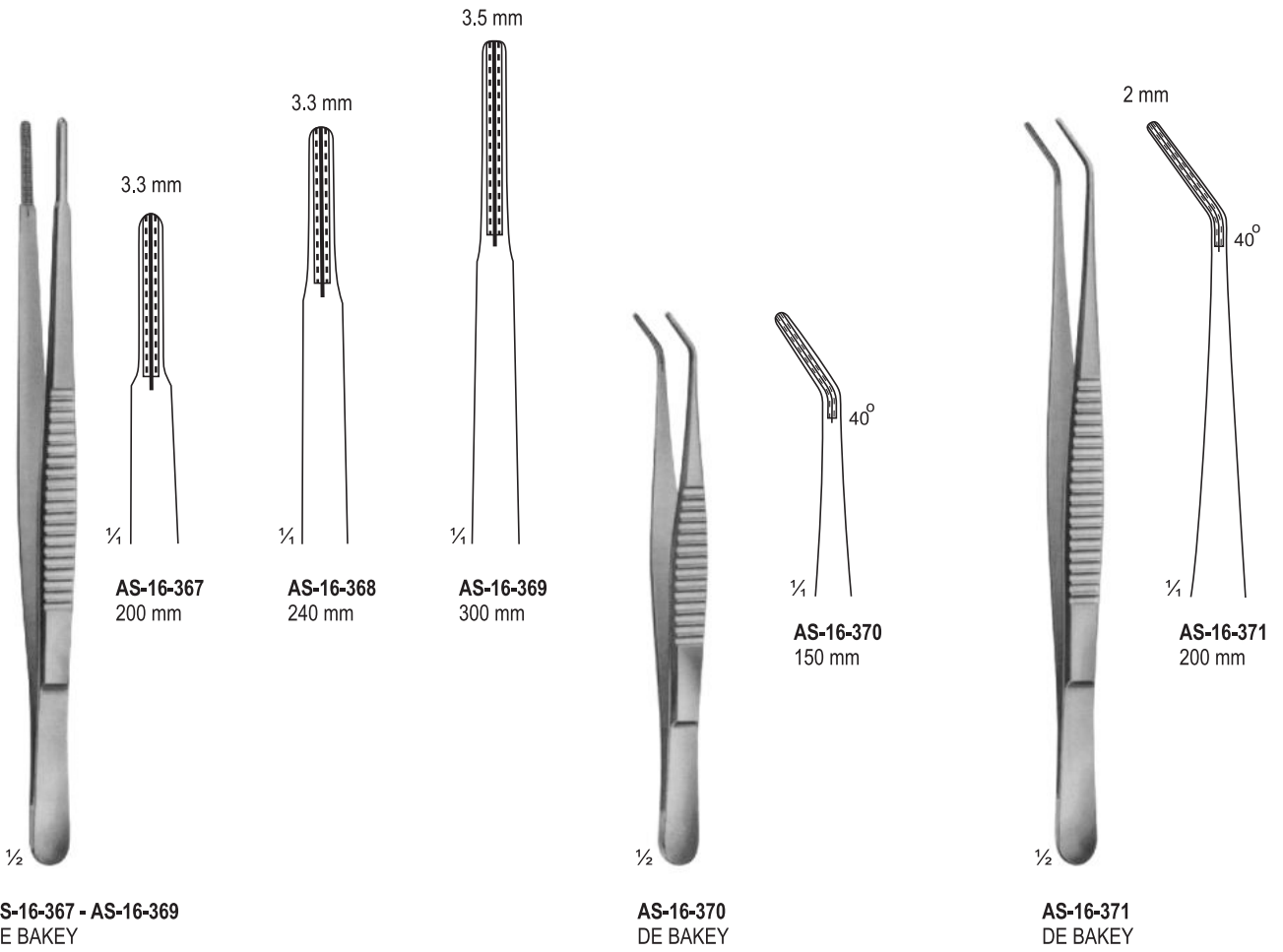

ULTRA - LIGHT - FORCEPS, DISSECTING FORCEPS



1/2

AS-16-372 150 mm
AS-16-373 200 mm
AS-16-374 240 mm
AS-16-375 300 mm

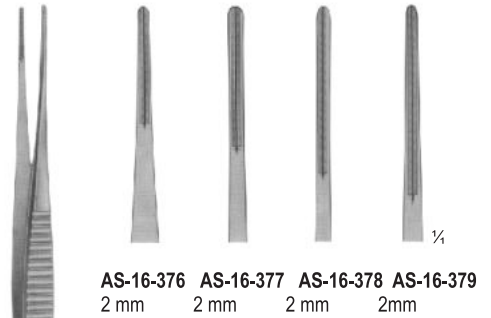

1/2

DE BAKEY
AS-16-376 150 mm
AS-16-377 200 mm
AS-16-378 240 mm
AS-16-379 300 mm

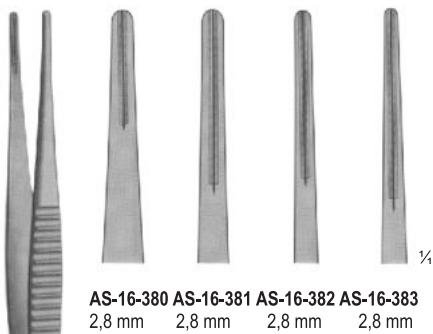

1/2

DE BAKEY
AS-16-380 150 mm
AS-16-381 200 mm
AS-16-382 240 mm
AS-16-383 300 mm

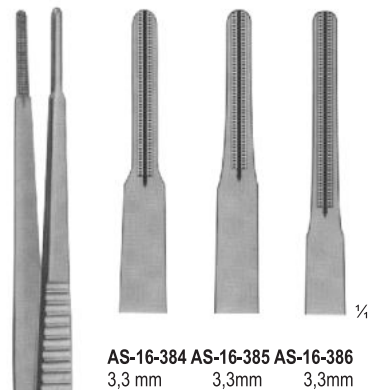

1/2

DE BAKEY
AS-16-384 200 mm
AS-16-385 240 mm
AS-16-386 300 mm

MULLER VESSEL CLIPS AND BULLDOG CLAMPS

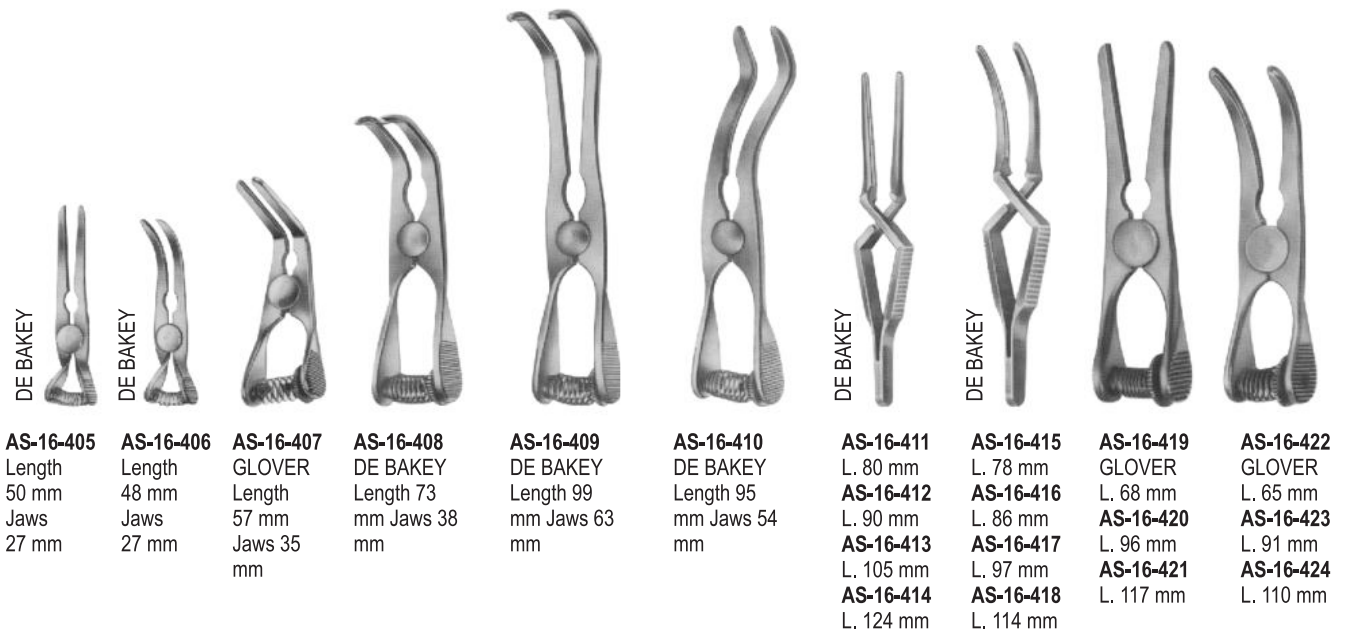
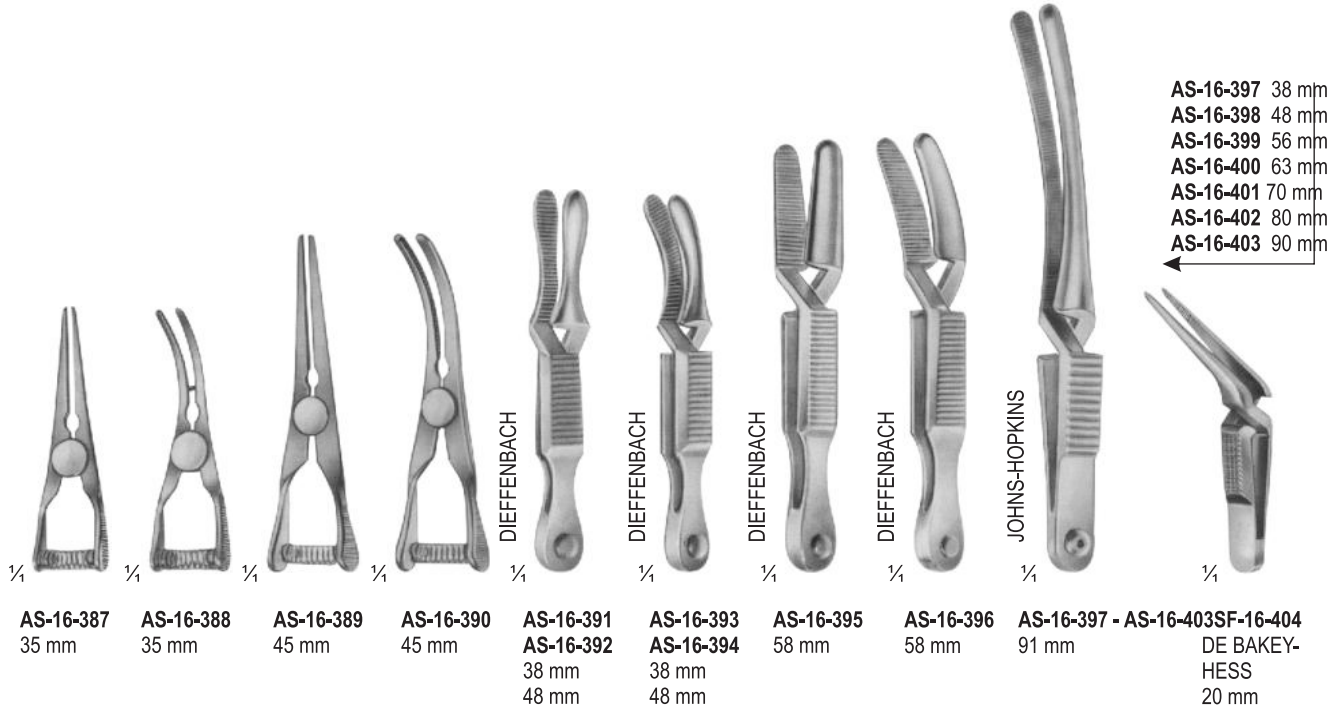

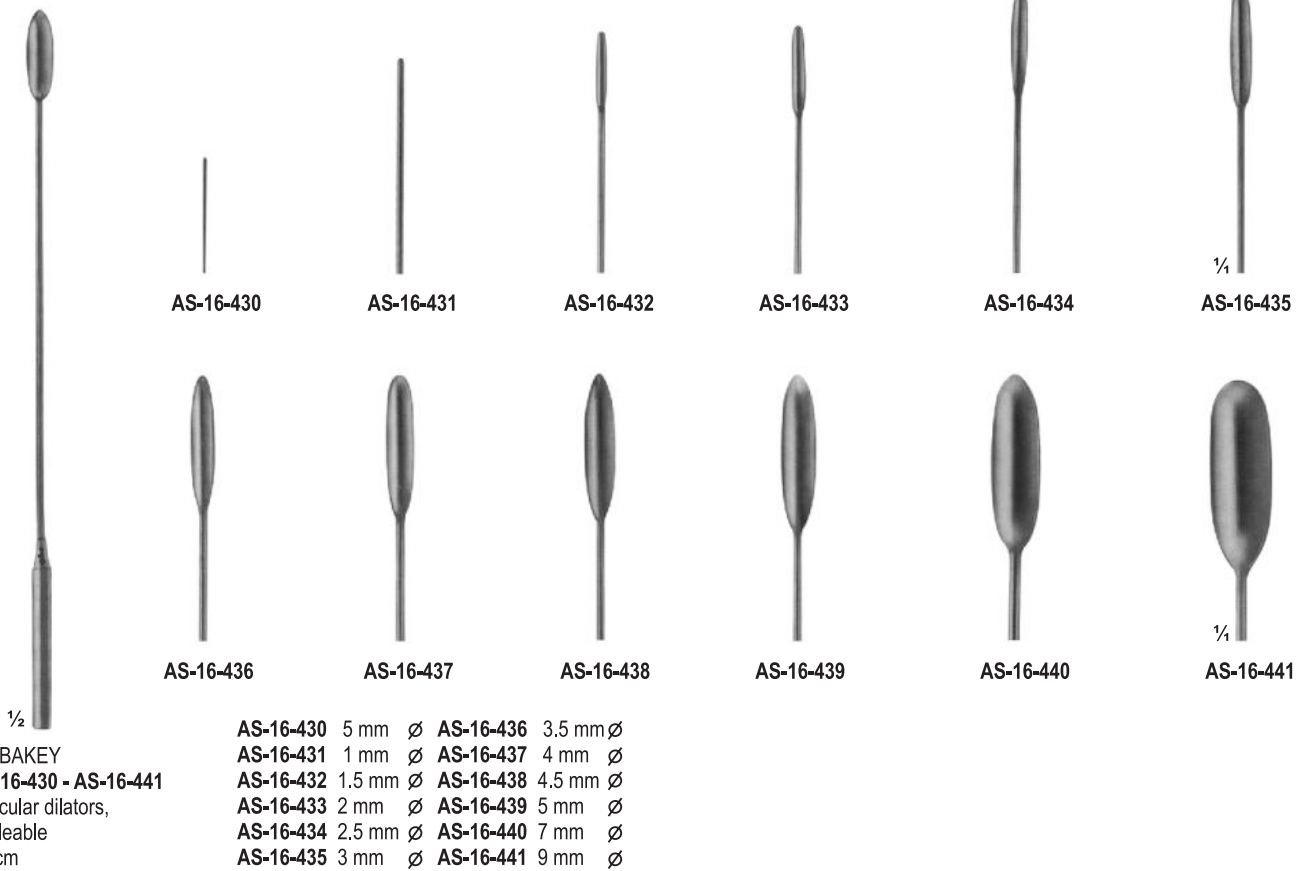
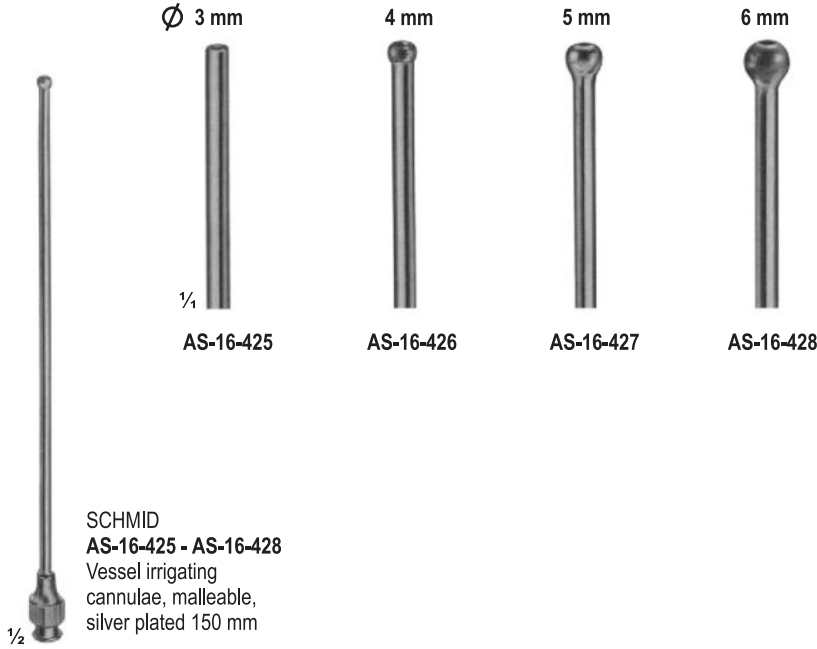

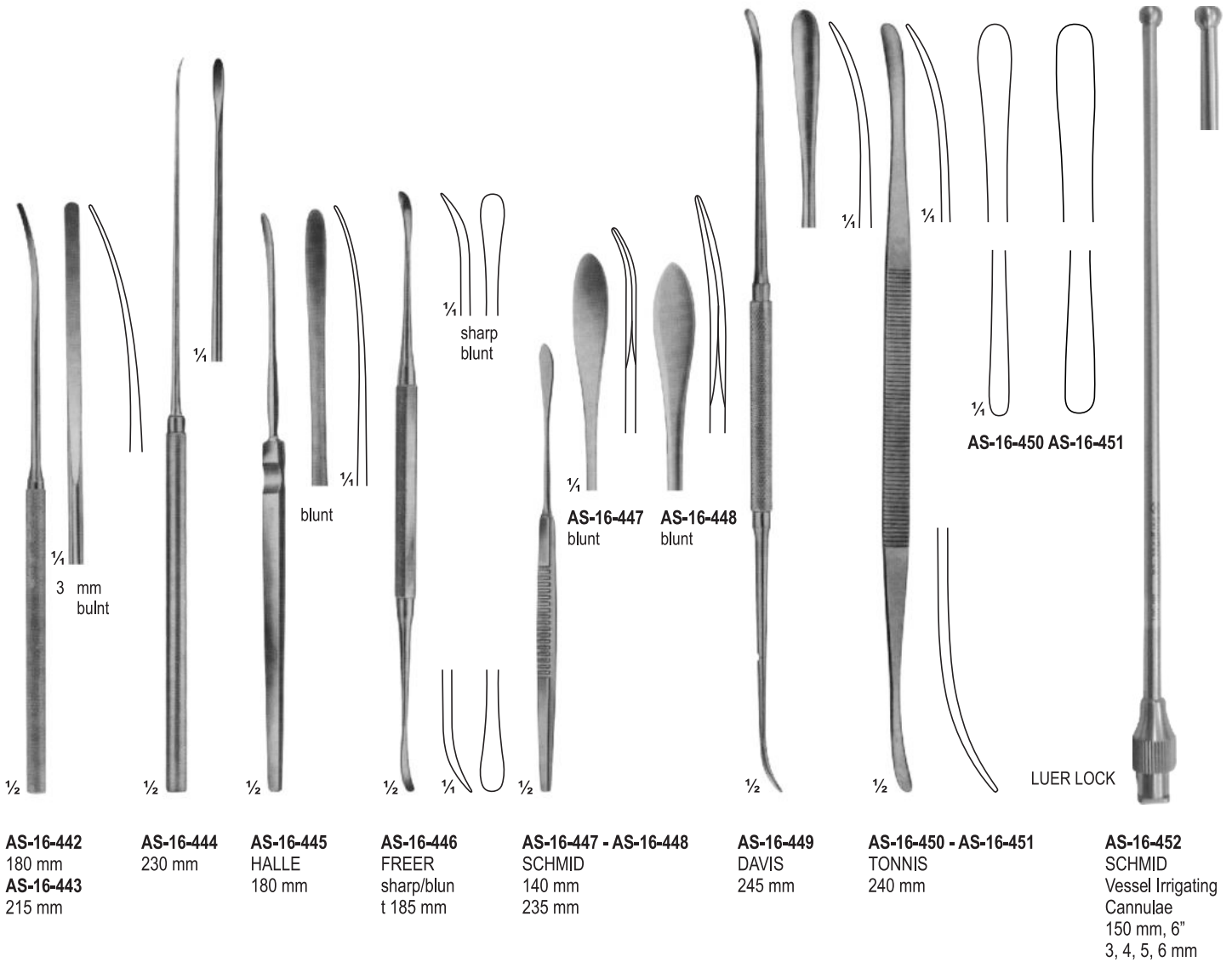

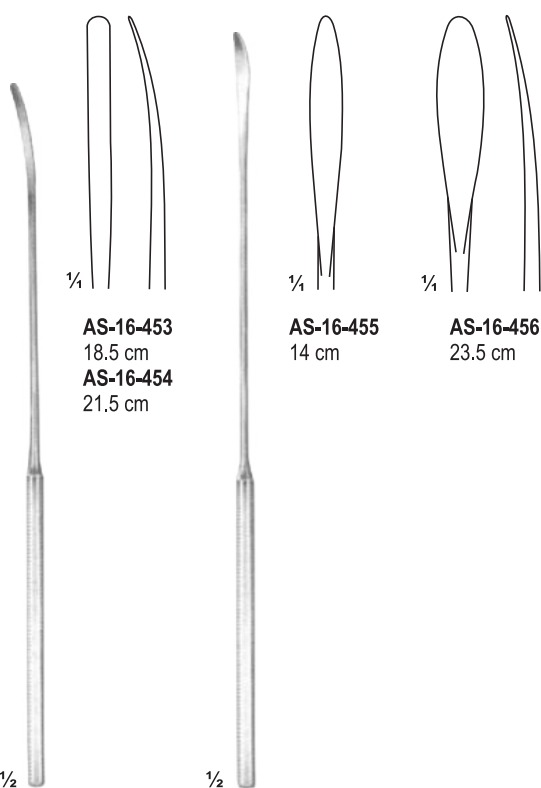

AS-16-453
18.5 cm
AS-16-454
21.5 cm

AS-16-455
14 cm

AS-16-456
23.5 cm

AS-16-453 - AS-16-454

AS-16-455 - AS-16-456

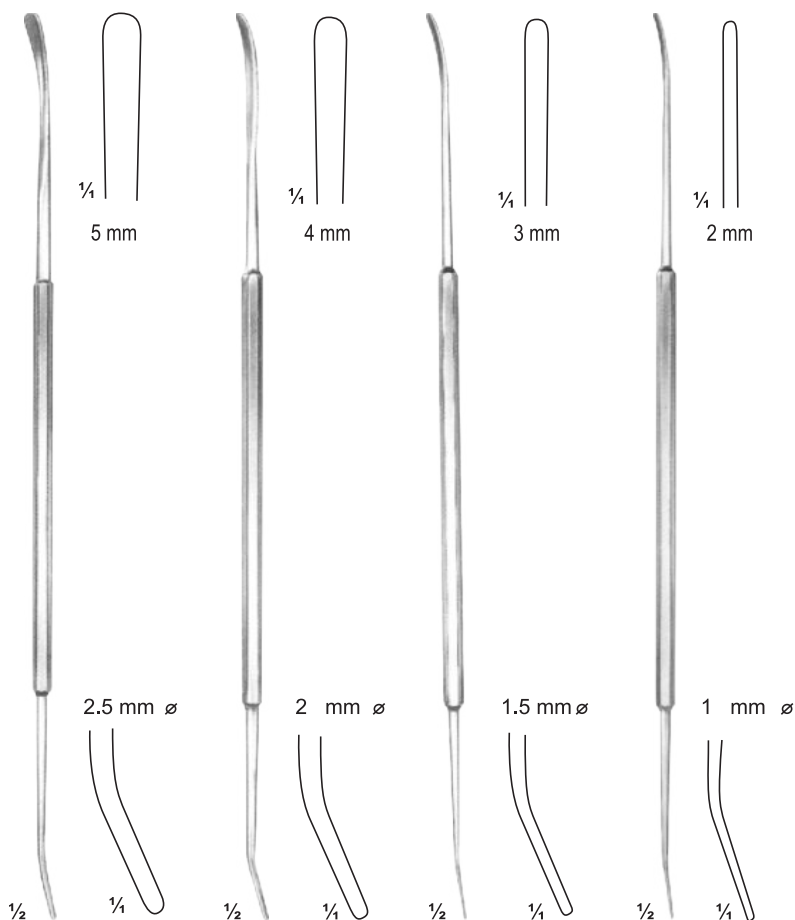

Fig. 1
ROBB **AS-16-457** 24 cm

Fig. 2
ROBB **AS-16-458** 24 cm

Fig. 3
ROBB **AS-16-459** 24 cm

Fig. 4
ROBB **AS-16-460** 24 cm



CRILE
AS-16-461
20 cm



CRILE
AS-16-462
20.5 cm



AS-16-463 - AS-16-466
26 cm



AS-16-463
1.5 mm \varnothing



AS-16-464
2 mm \varnothing



AS-16-465
2.5 mm \varnothing



AS-16-466
3 mm \varnothing

NERVE HOOKLETS, TOURNIQUETS



ASAMAR
SURGICAL



AS-16-467 - AS-16-475
Endarterectomy strippers
55 cm

-  **AS-16-468**
3 mm
-  **AS-16-469**
5 mm
-  **AS-16-470**
6 mm
-  **AS-16-471**
7 mm
-  **AS-16-472**
8.5 mm
-  **AS-16-473**
10 mm
-  **AS-16-474**
12 mm
-  **AS-16-475**
14mm



AS-16-476
Handle for
11 cm



RUMEL-BELBONT
AS-16-477 - AS-16-478
32.5 cm
AS-16-477 - 4 mm \varnothing
AS-16-478 - 6.4 mm \varnothing

AS-16-479 - AS-16-480
Guide only

BIOPOTOME & AORTIC DILATORS

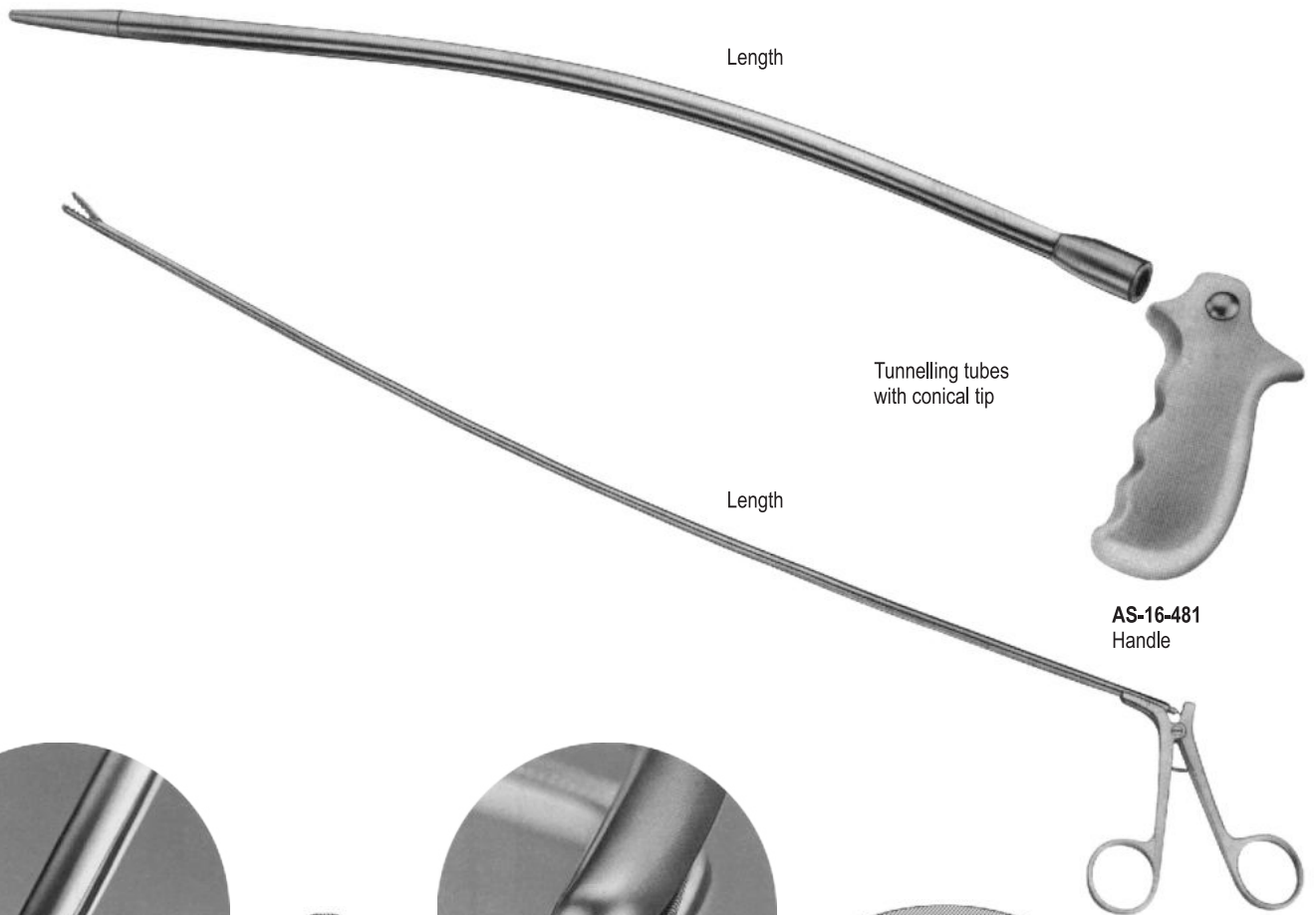

Tunnelling tubes with conical tip

AS-16-481
Handle

AS-16-482 - AS-16-485
Forceps



DE BAKEY
AS-16-482
1 : 2 rows of teeth

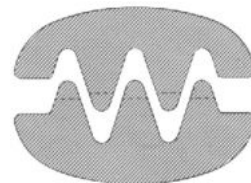

DE BAKEY
AS-16-483
2 : 3 rows of teeth

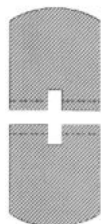
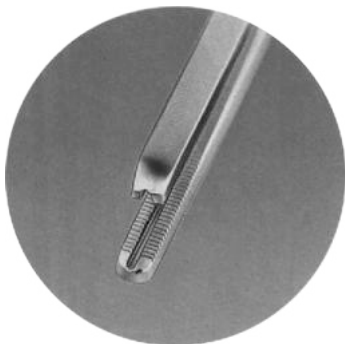

COOLEY
AS-16-484
2 : 2 rows of teeth

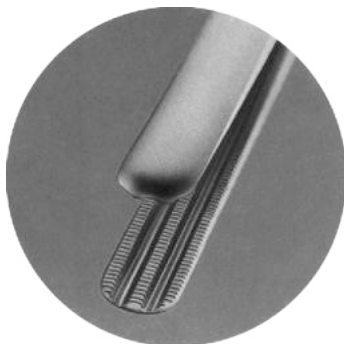

DARDIK
AS-16-485
2 : 3 rows of teeth

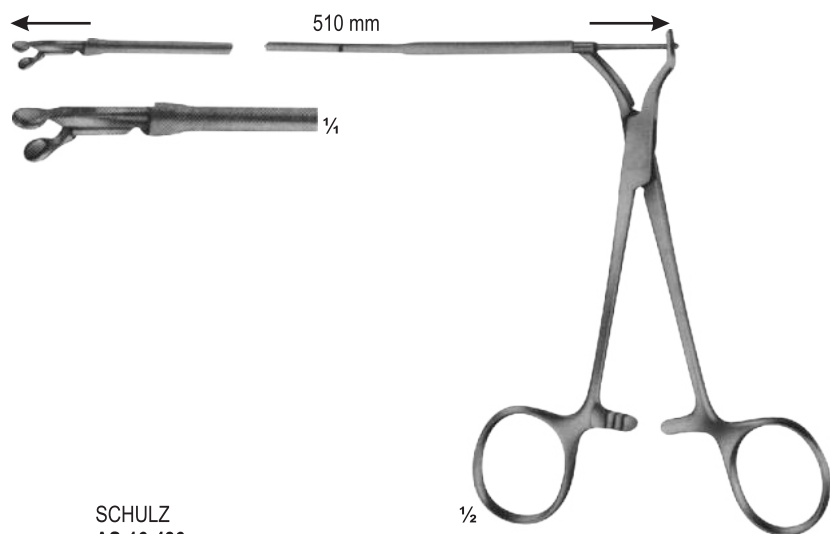

SCHULZ
AS-16-486
Biopptome, mit flexiblem Schaft, 510 mm lang, with round jaws 3 mm diam.

Biopsy forceps, for biopsy from the right atrium through cava juglaris, prior to heart implantations.

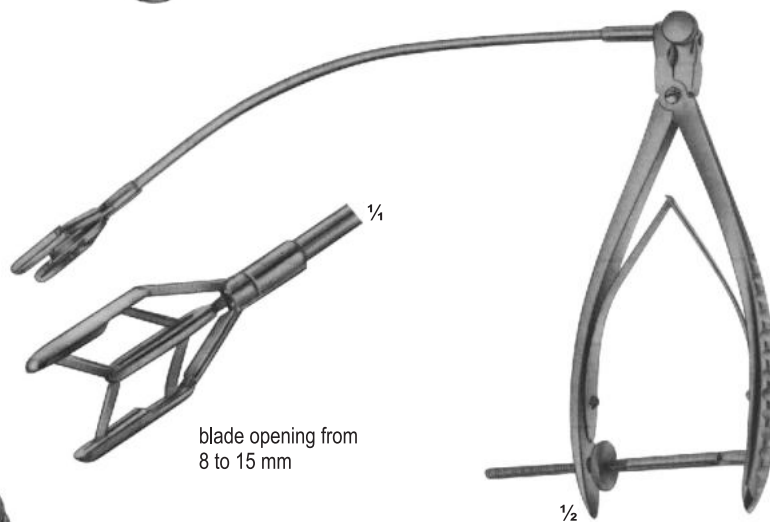

blade opening from 8 to 15 mm

COOLEY
AS-16-487
Dilator for mitral valve for children

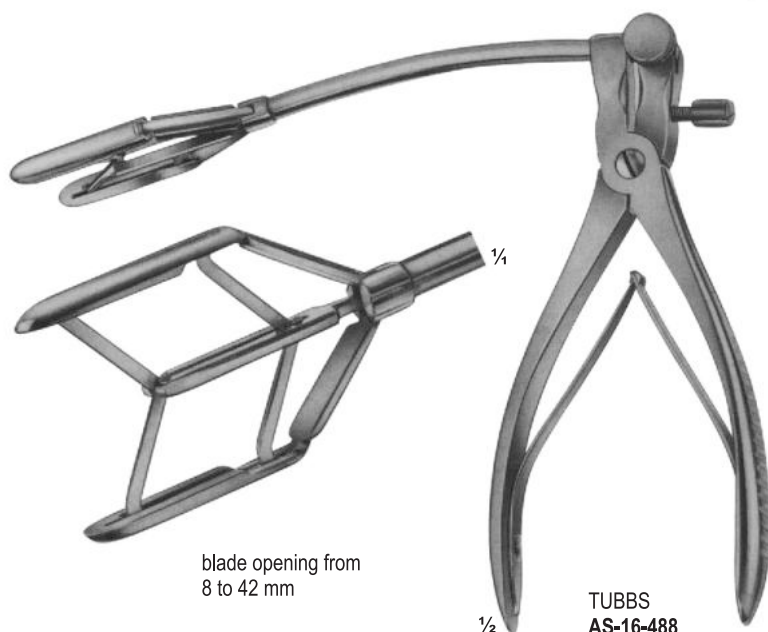

blade opening from 8 to 42 mm

TUBBS
AS-16-488
Dilator for mitral valve



1/2
SCHUMACHER
Sternum shears
AS-16-489
210 mm



1/3
GIERTZ-STILLE
AS-16-490
250 mm



1/2
GLUCK
AS-16-491
190 mm



1/3
BRUNNER
Universal Pattern
AS-16-492
340 mm

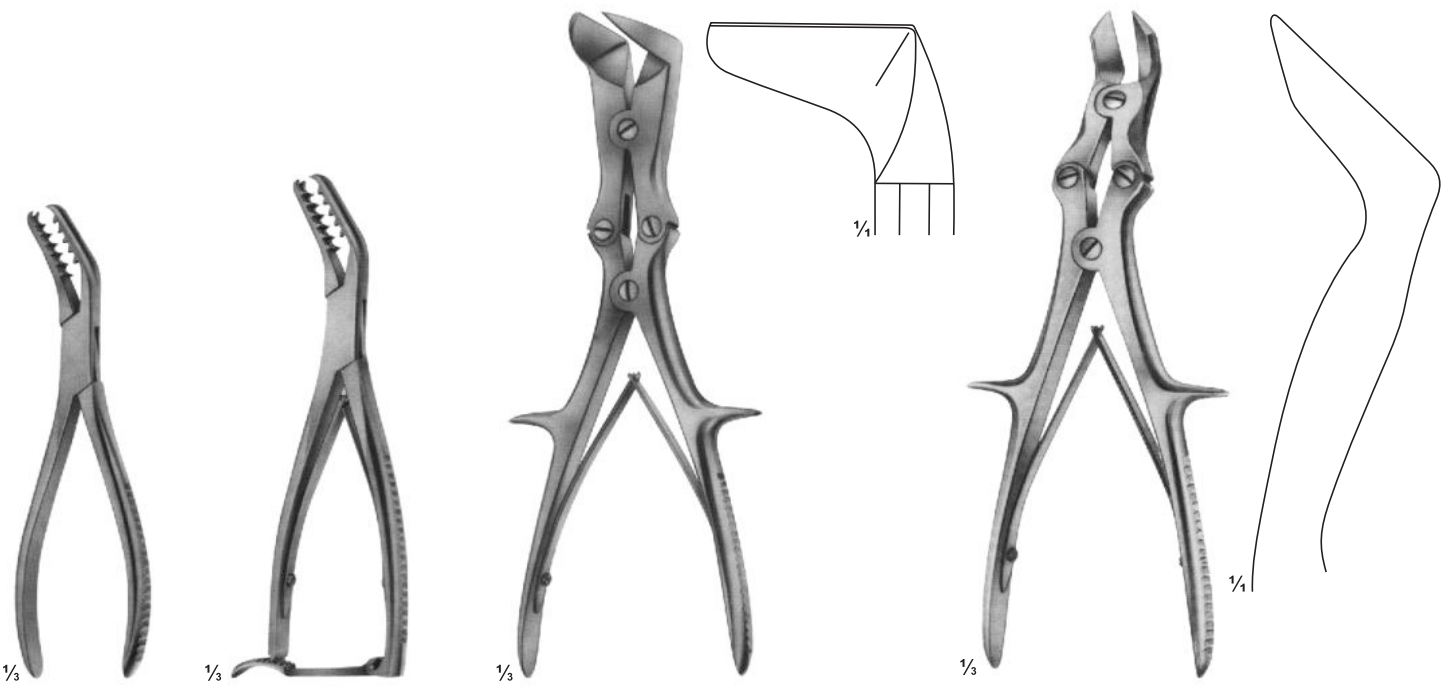

AS-16-493
SEMB
Rib-and Bone
Holding
forceps 190
mm

AS-16-494
SEMB
Rib-and Bone
Holding
forceps 190
mm

AS-16-495
LISTON-STILLE
265 mm

AS-16-496 LISTON-
KEY-HORSLEY 255 mm

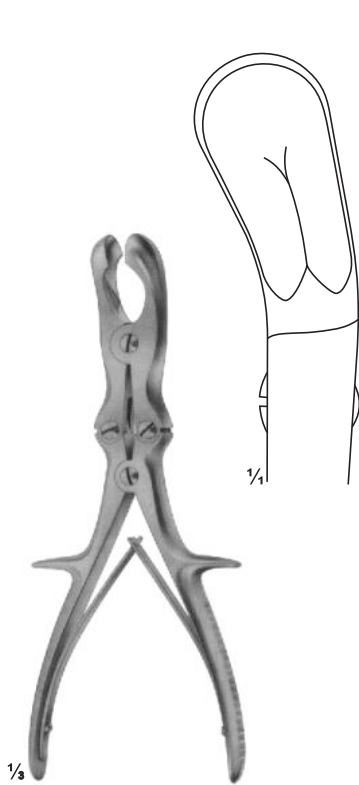

AS-16-497 SEME
Rib Rongeur to shorten
the rib stumps
240 mm

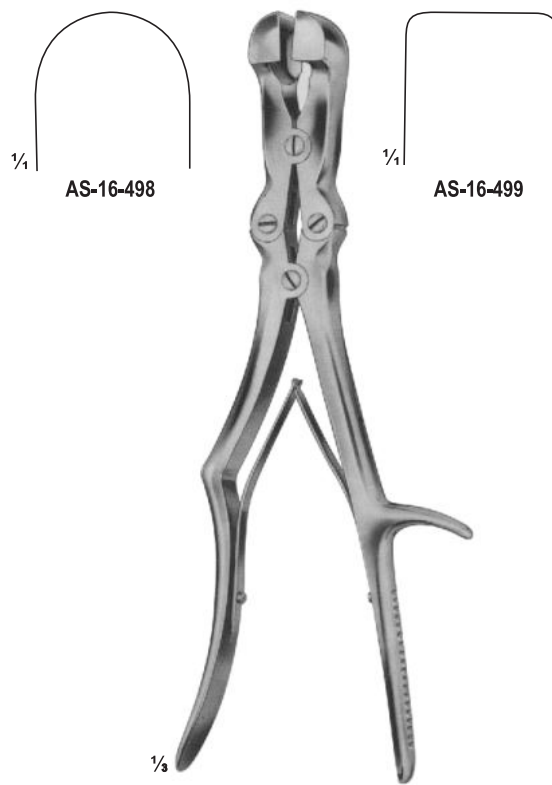

AS-16-498 - AS-16-499
SAUERDRUCH-CORYLLOS
Rib rongeurs to shortn
the rib stumbe
310 mm

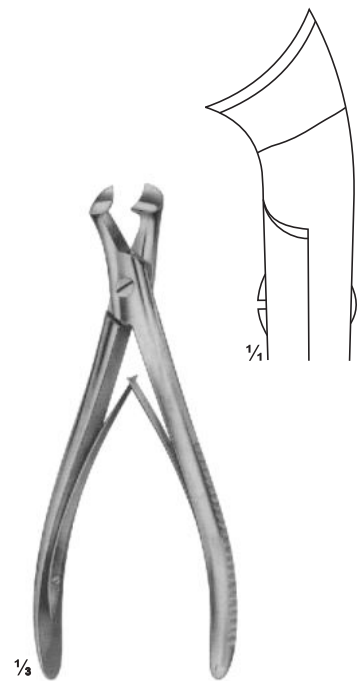

AS-16-500
MARKWALDER
Rib Rongeur to Round
the rib stumps
190 mm

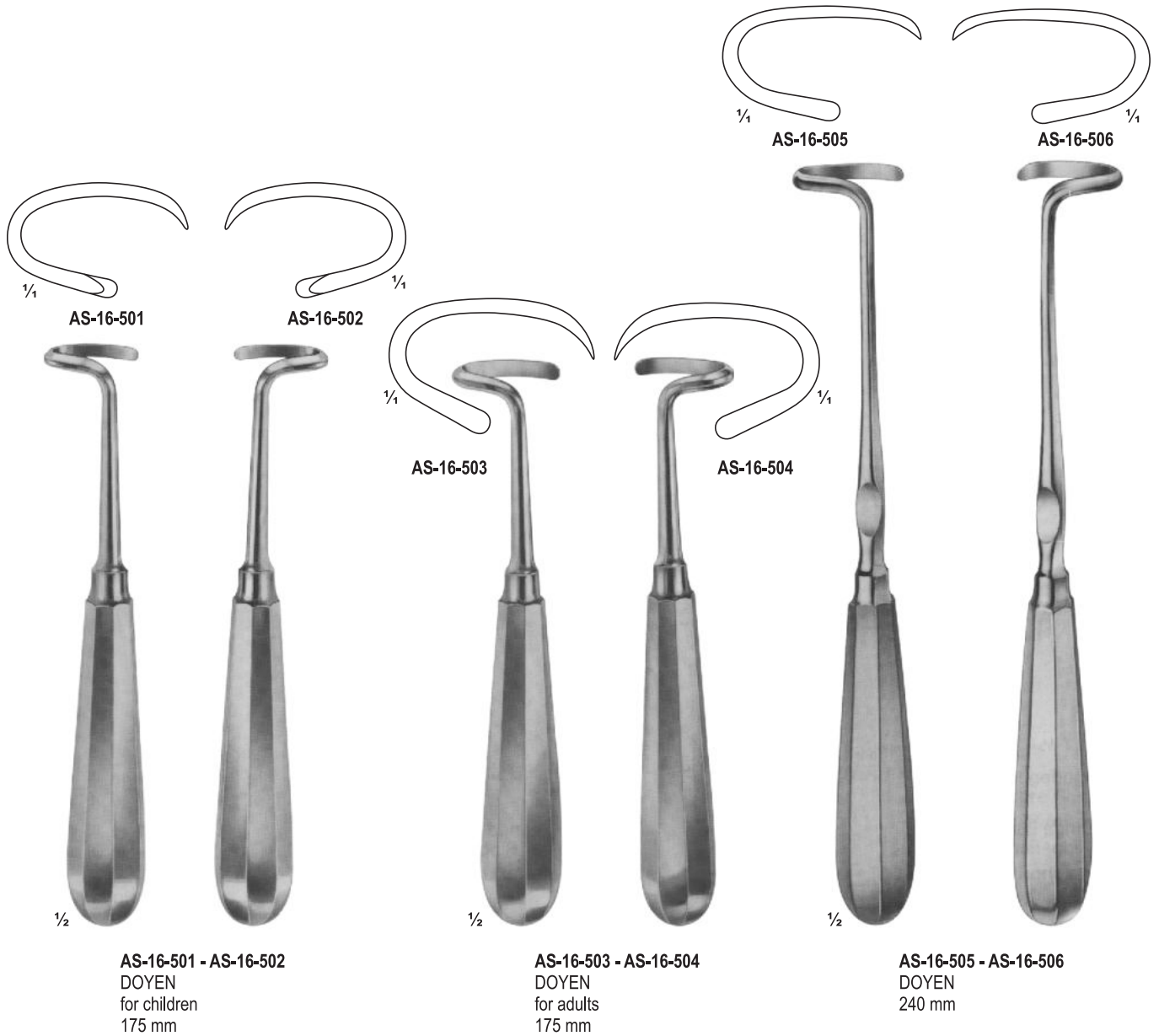

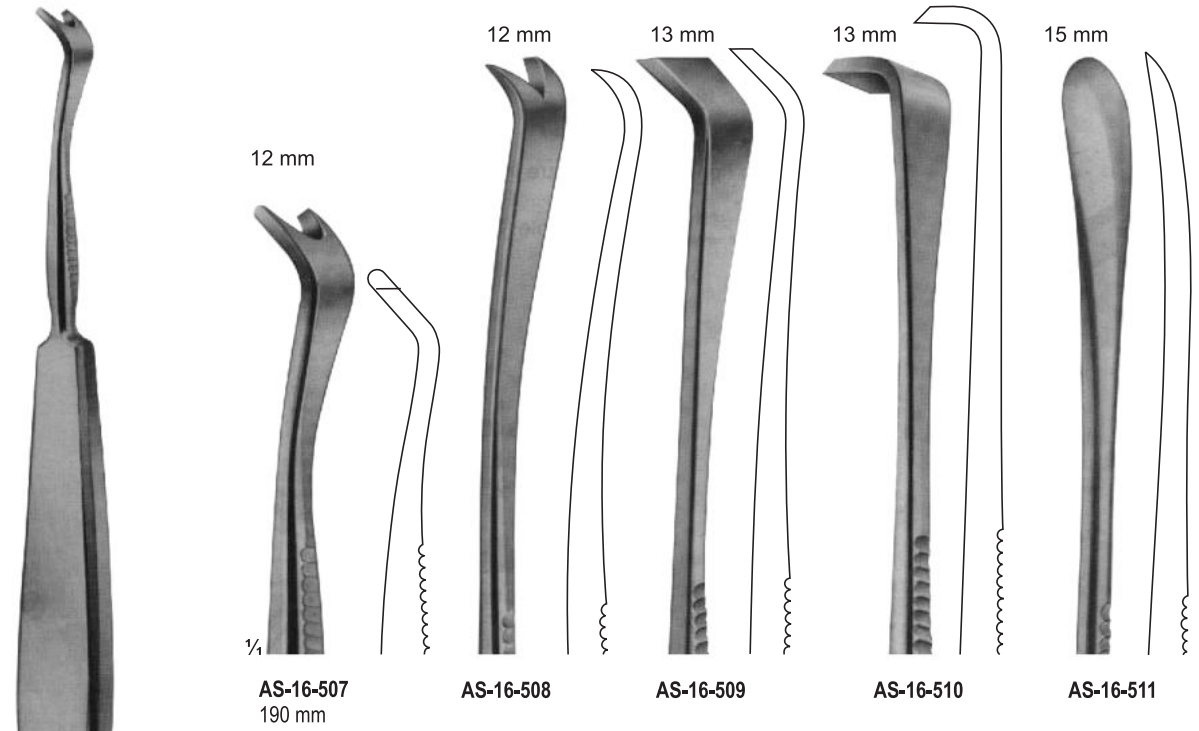

1/2
AS-16-507 - AS-16-511
SEMB
230 mm

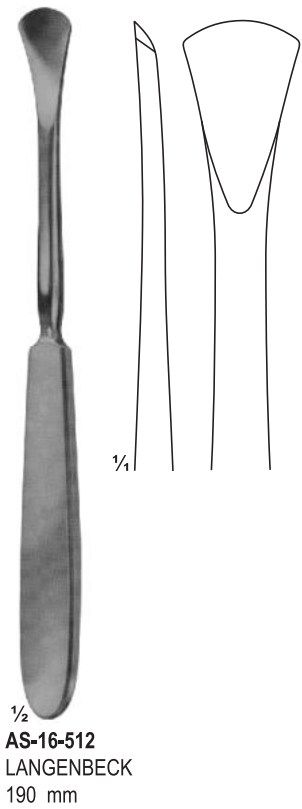

1/2
AS-16-512
LANGENBECK
190 mm

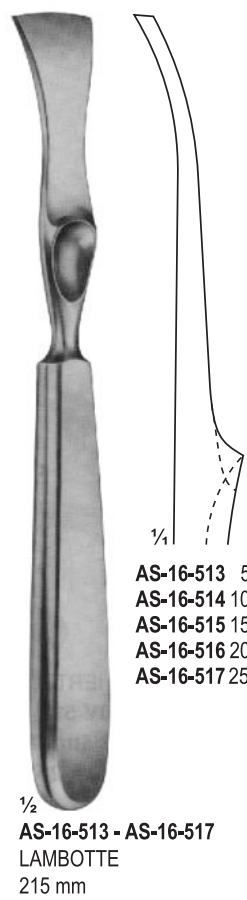

1/2
AS-16-513 5 mm
AS-16-514 10 mm
AS-16-515 15 mm
AS-16-516 20 mm
AS-16-517 25 mm
LAMBOTTE
215 mm

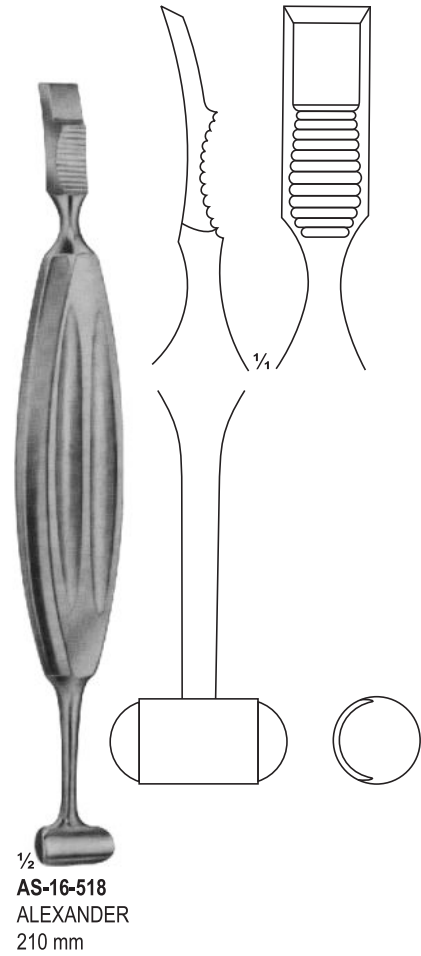

1/2
AS-16-518
ALEXANDER
210 mm



ASAMAR
SURGICAL 

PAGE

375-395

NEEDLE HOLDERS
SUTURE INSTRUMENTS
LIGATURE NEEDLES
GUIDING PROBES

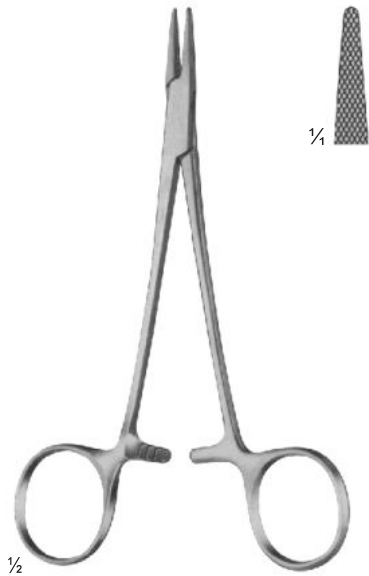

½

CRILE-MURRAY
AS-17-101
15 cm



½

CRILE-WOOD
AS-17-102
16 cm

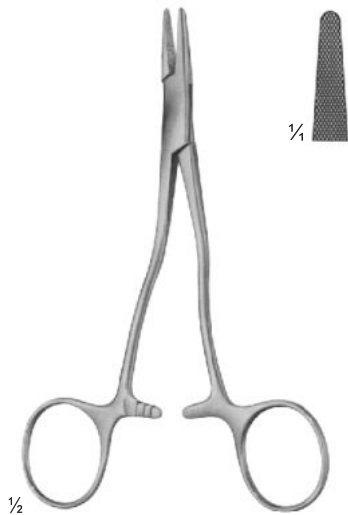

½

KILNER
AS-17-103
13.5 cm



½

ADSON
AS-17-104
17.5 cm

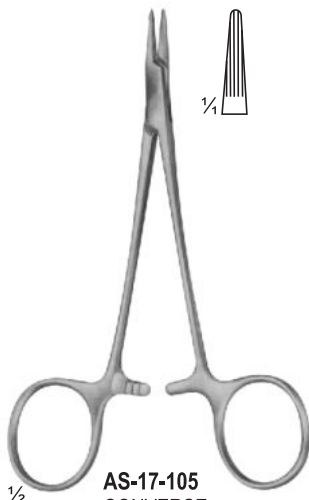

AS-17-105
CONVERSE
125 mm

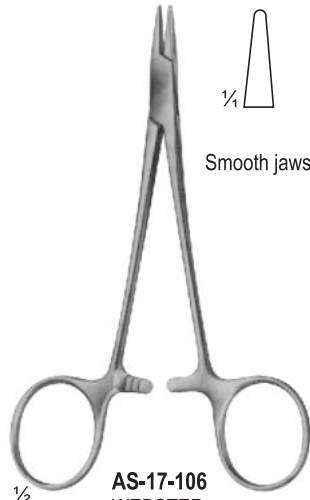

AS-17-106
WEBSTER
125 mm

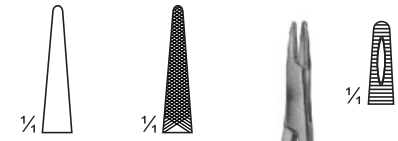

AS-17-107 **AS-17-108**
Smooth jaws

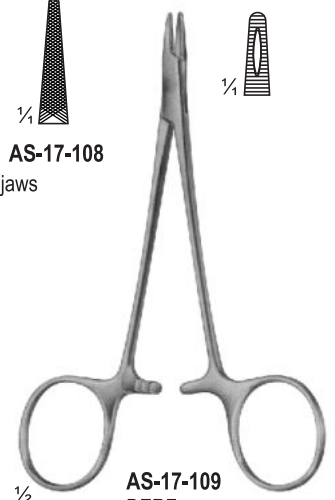

AS-17-109
DERF
130 mm

AS-17-107 - AS-17-108
HALSEY
130 mm

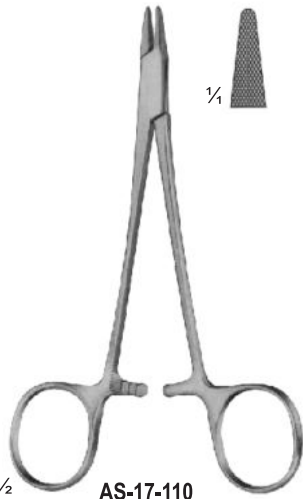

AS-17-110
BAUMGARTNER
145 mm

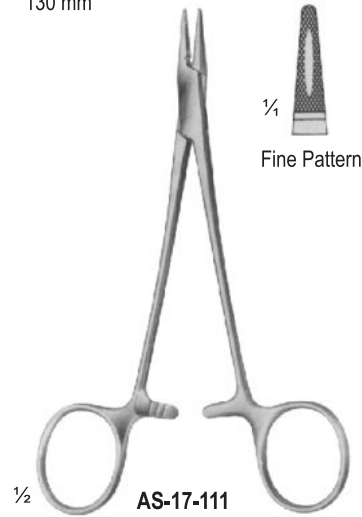

AS-17-111
CRILE-WOOD
150 mm

AS-17-111
CRILE-WOOD
150 mm
Fine Pattern

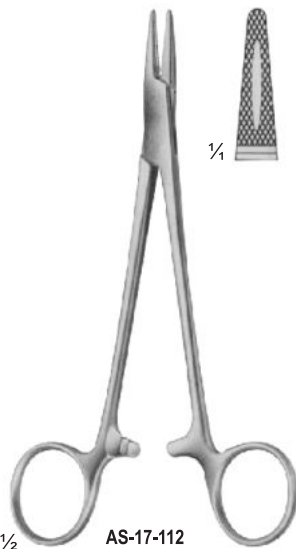

AS-17-112
CRILE-WOOD
160 mm

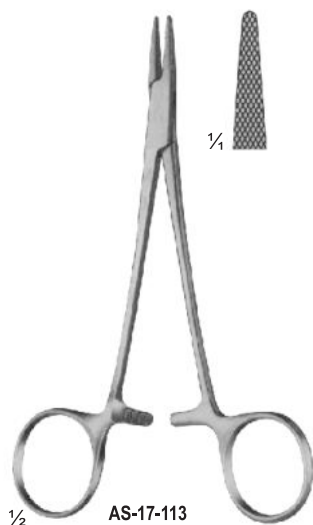

AS-17-113
CRILE-MURRAY
150 mm



AS-17-114
KILNER
135 mm

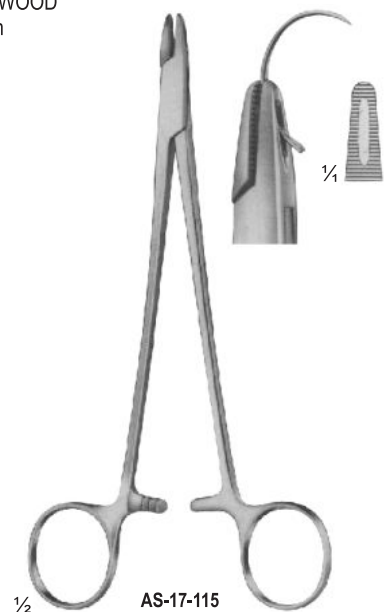

AS-17-115
ADSON
175 mm

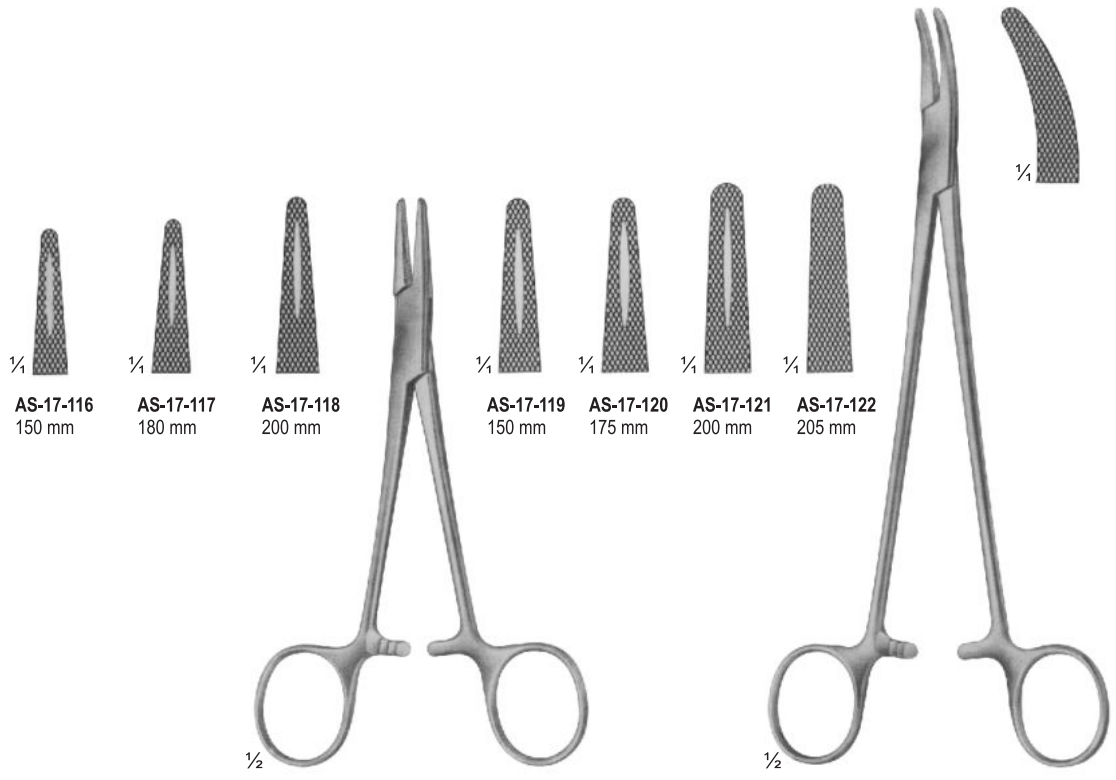

$\frac{1}{2}$
AS-17-116 - AS-17-118
 MAYO-HEGAR
 Medium fine patterns

$\frac{1}{2}$
AS-17-119 - AS-17-122
 HEGAR
 Heavy Patterns

$\frac{1}{2}$
AS-17-123
 HEANEY (HEGAR)
 200 mm

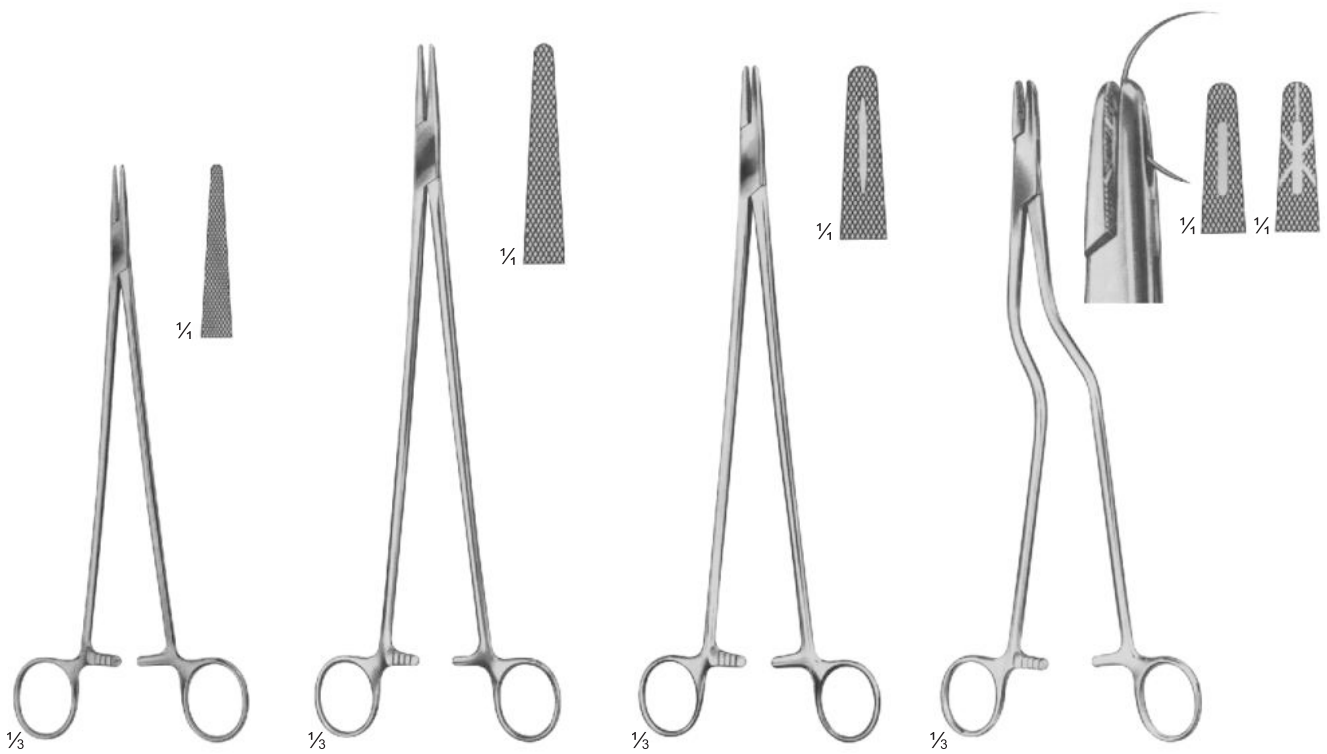

AS-17-124
 JAMESON
 230 mm

AS-17-125
 WANGENSTEEN
 275 mm

AS-17-126
 MASSON
 265 mm

AS-17-127
 MASSON-LUETHY
 255 mm

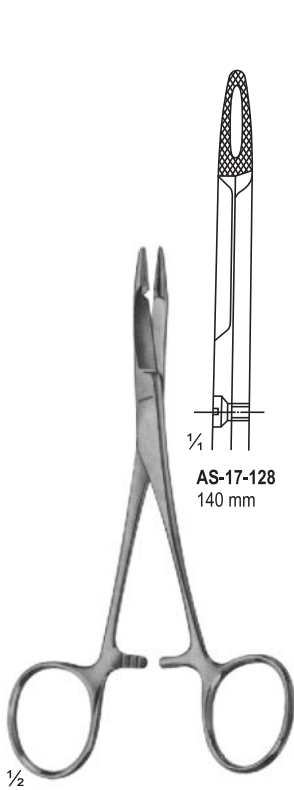

AS-17-128
140 mm

AS-17-129
185 mm

AS-17-128 - AS-17-129
HEGAR-OLSEN
255 mm

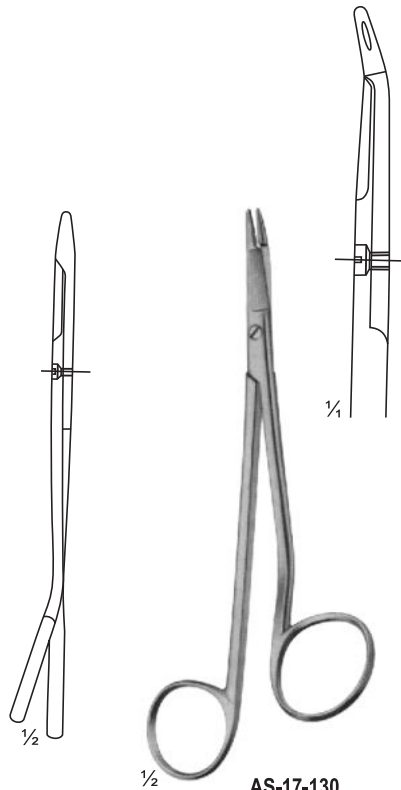

AS-17-130
GILLIES
150 mm

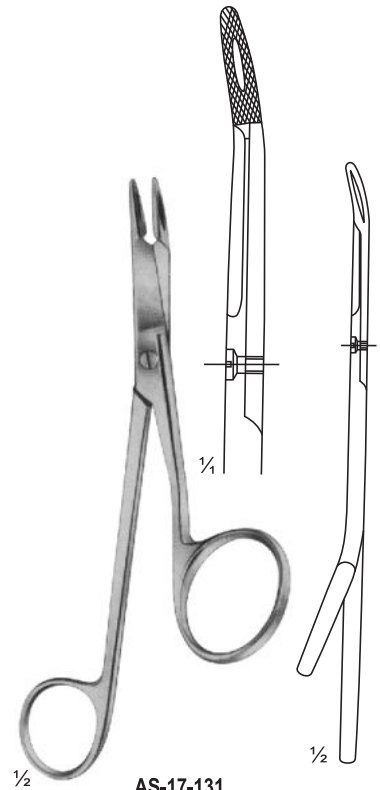

AS-17-131
GILLIES
160 mm

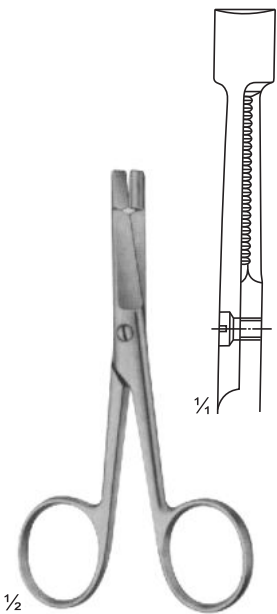

AS-17-132
EISELSBERG
115 mm

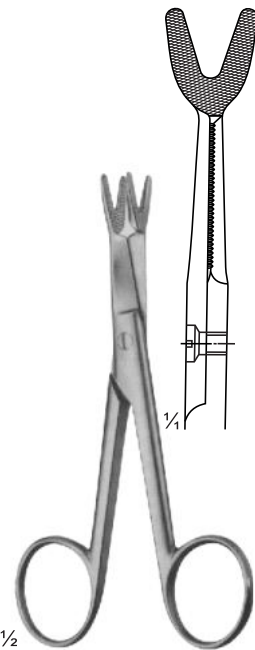

AS-17-133
SCHOEMAKER-LOTH
125 mm



AS-17-134
CRILE
150 mm



AS-17-135
TOENNIS
Elastic pattern for dura-
or intestinal suture 180
mm

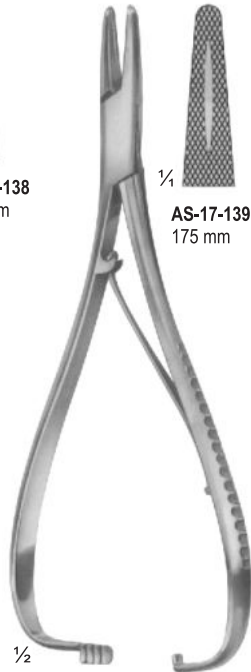
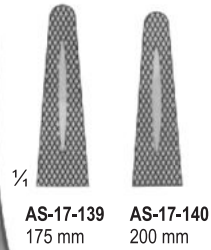
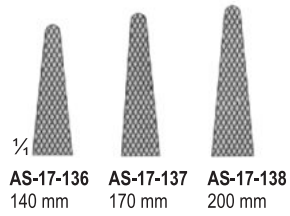

AS-17-139 - AS-17-140
MATHIEU-STILLE
Very heavy models



AS-17-141
BOYNTON
125 mm



AS-17-142
EISELSBERG-MATHIEU
For palate suture
195 mm



AS-17-143
MATHIEU-KOCHER



AS-17-144
BOYNTON
125 mm



AS-17-145 MILLIN
Ligature holding forceps
245 mm

SUTURE INSTRUMENTS REVERDIN NEEDLES

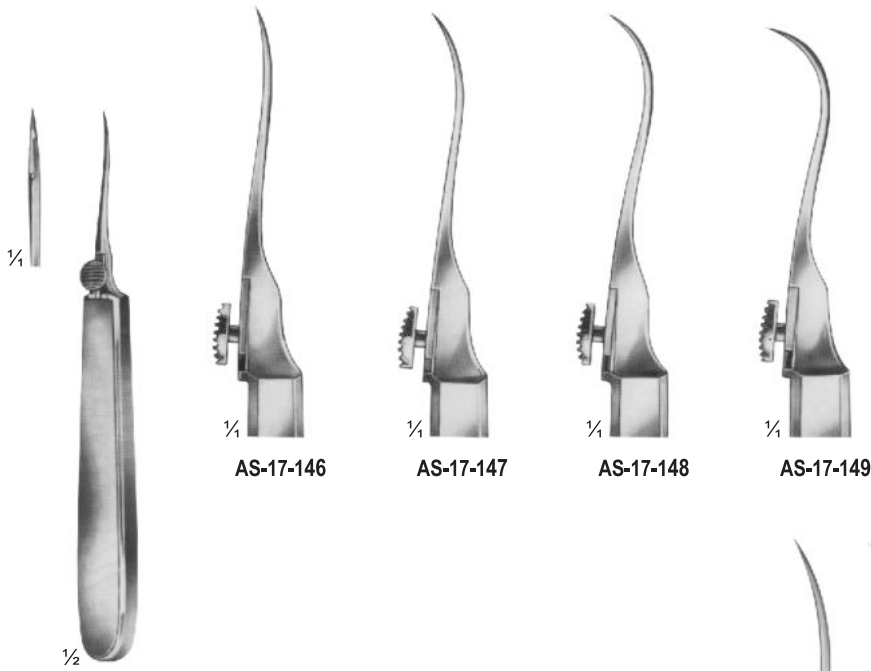

AS-17-146 AS-17-147 AS-17-148 AS-17-149

AS-17-146 - AS-17-149
REVERDIN
140 mm



AS-17-150 AS-17-151 AS-17-152 AS-17-153 AS-17-154 AS-17-155 AS-17-156 AS-17-157

AS-17-150 - AS-17-153
REVERDIN
195 mm

AS-17-154 - AS-17-157
REVERDIN
220 mm

SUTURE INSTRUMENTS LIGATURE NEEDLES

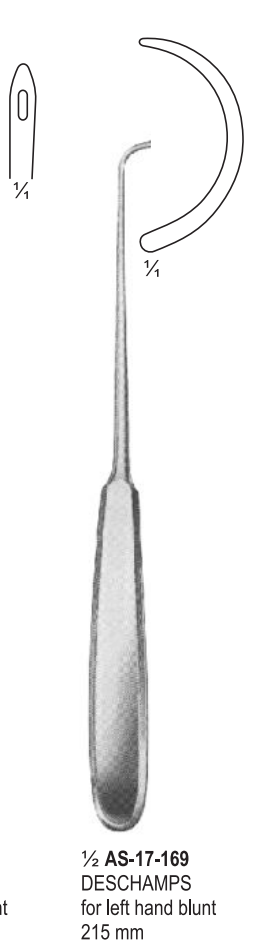
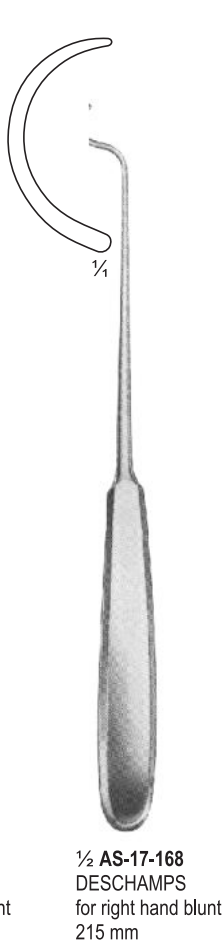
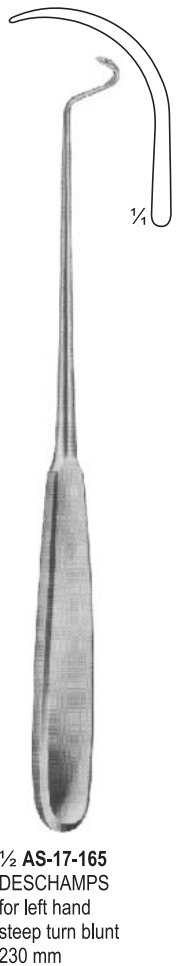
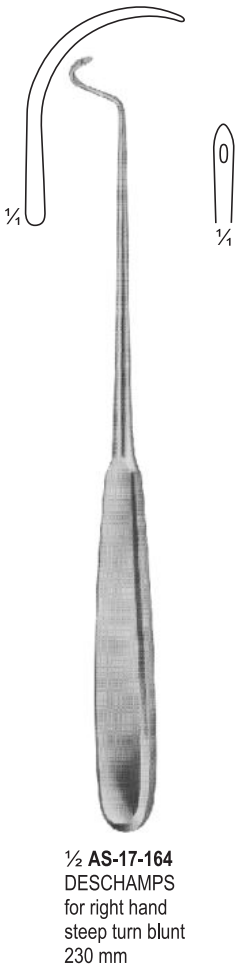

SUTURE INSTRUMENTS LIGATURE NEEDLES

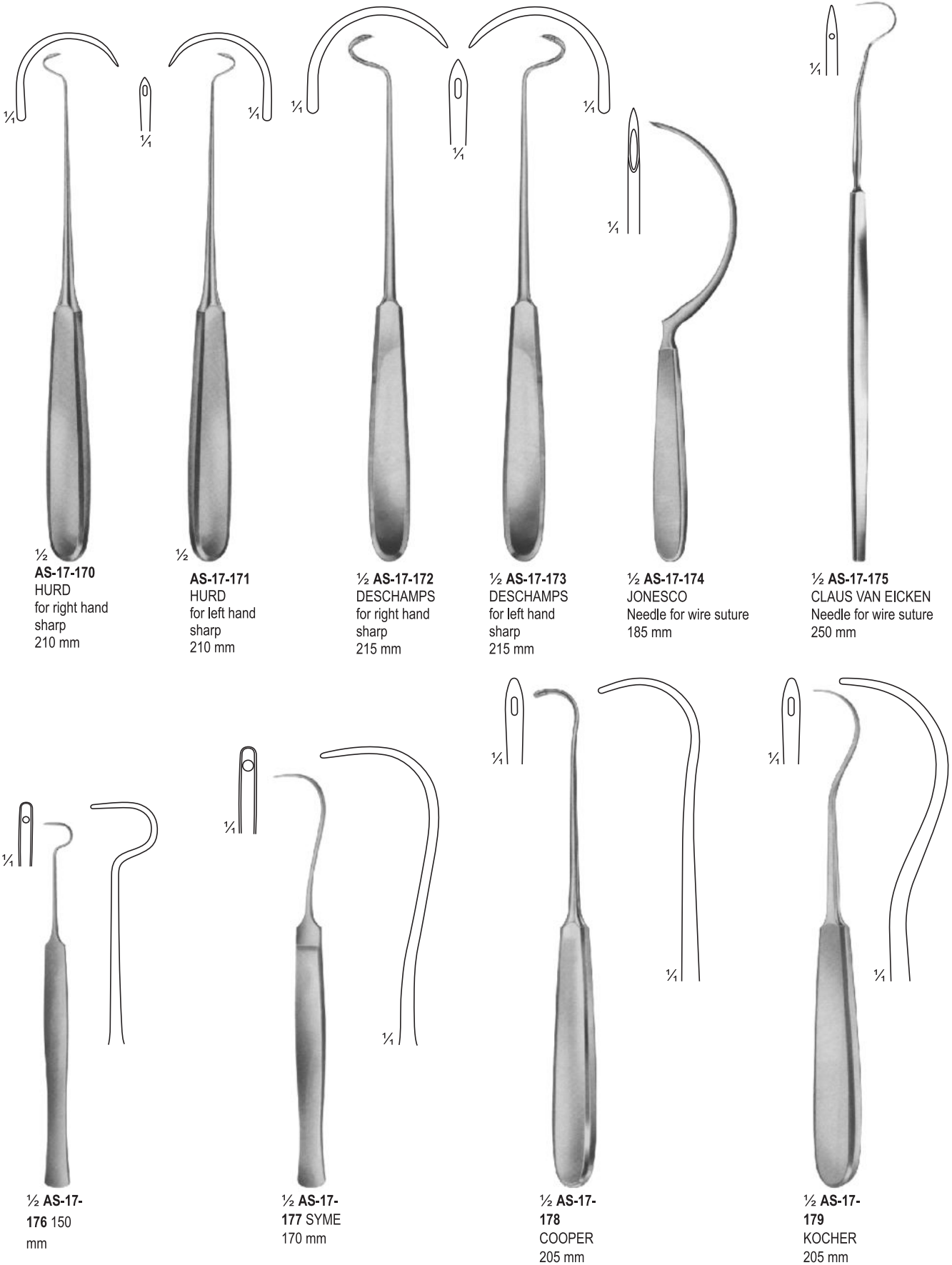

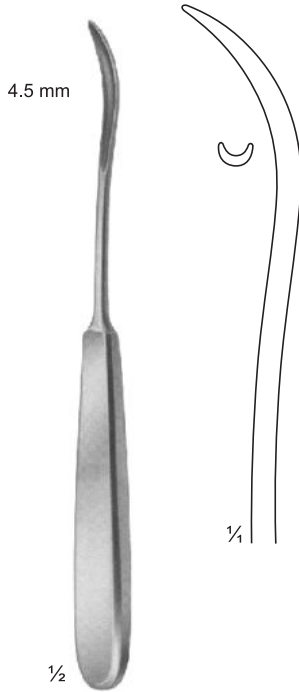

AS-17-180
KOENIG 195
mm

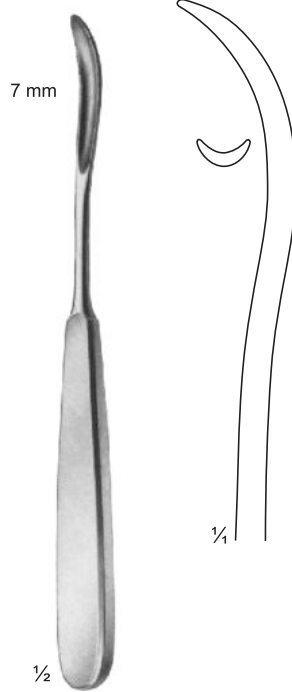

AS-17-181
KOENIG 200
mm

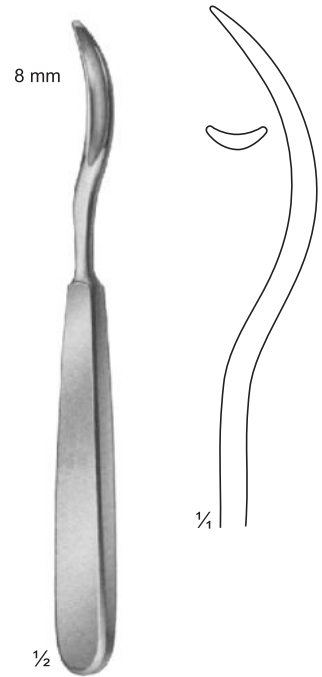

AS-17-182
SCHMIEDEN
185 mm

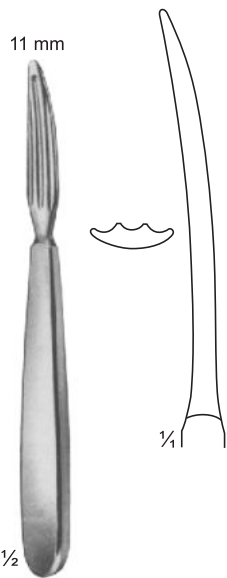

AS-17-183
KOCHER
150 mm

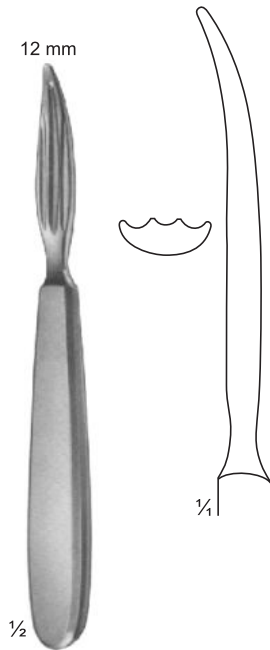

AS-17-184
KOCHER
170 mm

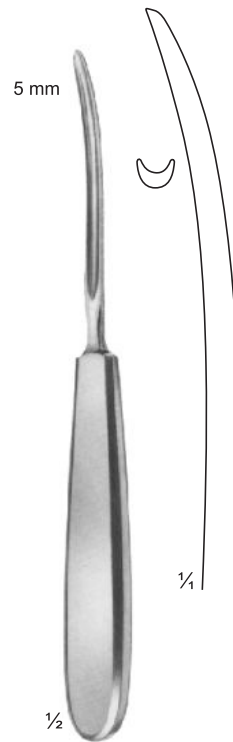

AS-17-185
PAYR
195 mm

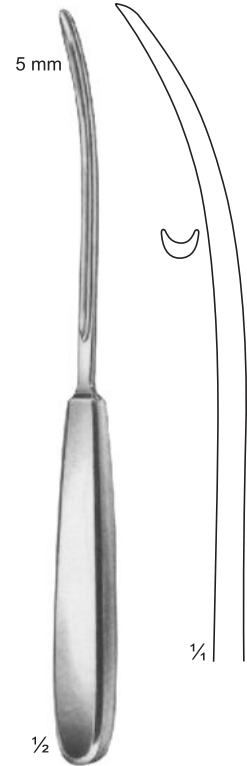

AS-17-186
PAYR 225 mm

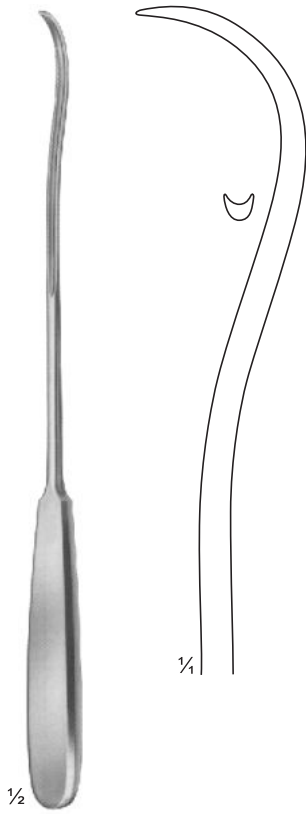

AS-17-187
280 mm

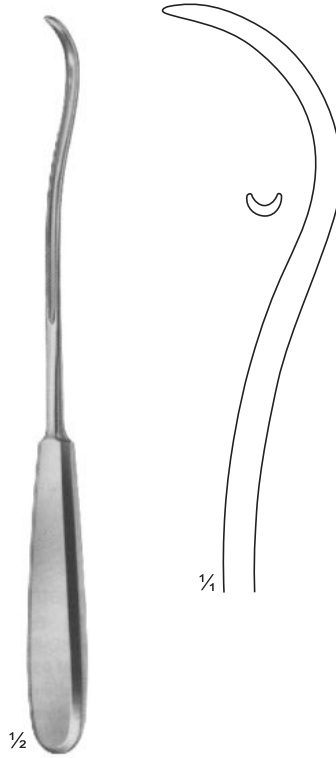

AS-17-188
KIRSCHNER
255 mm

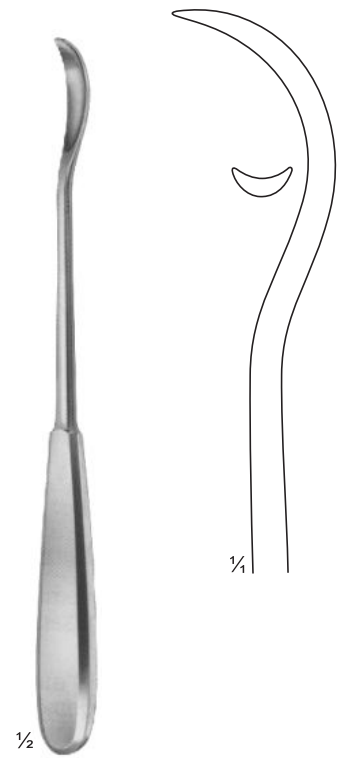

AS-17-189
BRUNNER
245 mm



AS-17-190
Ligature Adjuster
230 mm



AS-17-191
CASPER
Ligature Adjuster
230 mm



AS-17-192
WIENER MODEL
Suture hook
235 mm

SUTURE INSTRUMENTS LIGATURE NEEDLES

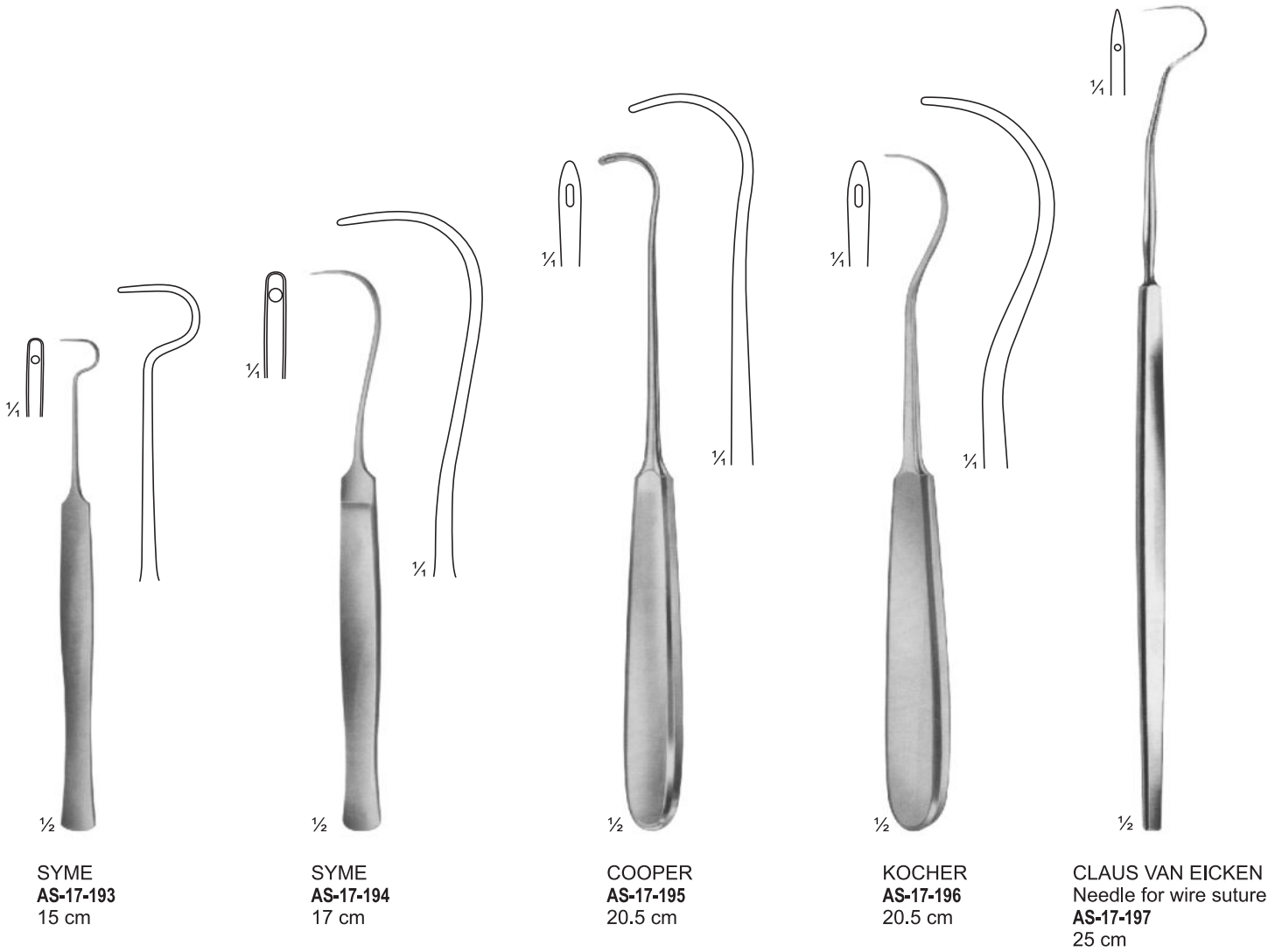

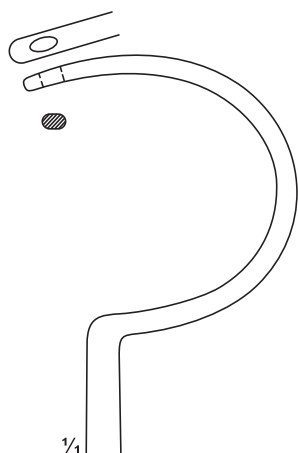

DEMEL
Wire guides
AS-17-198 - AS-17-200
AS-17-198 275 mm
AS-17-199 285 mm
AS-17-200 305 mm

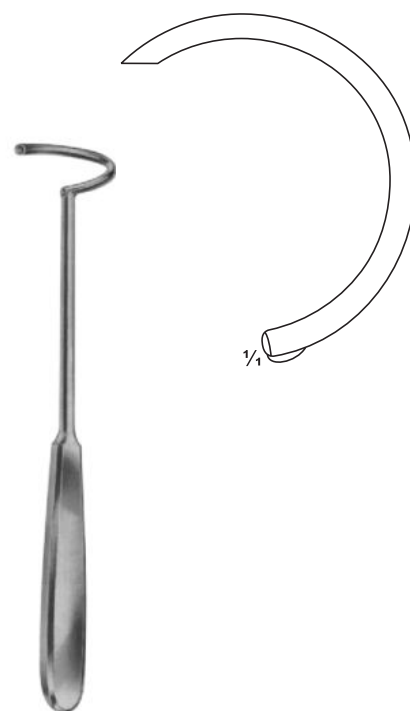

AS-17-201
225 mm

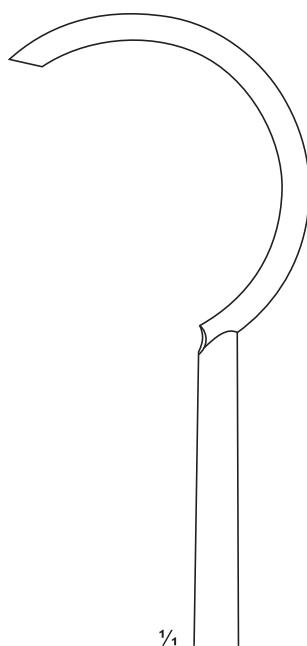

AS-17-202 - AS-17-203
AS-17-202 240 mm
AS-17-203 270 mm

NEEDLE HOLDERS WITH TUNGSTEN CARBIDE INSERTS



KALT AS-17-204
13.5 cm



DIETHRICH
AS-17-205 - AS-17-209
AS-17-205 16 cm
AS-17-206 18 cm
AS-17-207 20 cm
AS-17-208 23 cm
AS-17-209 26 cm



WEBSTER
AS-17-210
13 cm



DERF
AS-17-211
12 cm



HEGAR-BAUMGARTNER
AS-17-212 - AS-17-213
AS-17-212 12.5 cm
AS-17-213 14 cm

AS-17-212
12.5 cm

AS-17-213
14 cm



WEBSTER
AS-17-214
13 cm

NEEDLE HOLDERS WITH TUNGSTEN CARBIDE INSERTS



HALSEY
AS-17-215 - AS-17-216
13 cm

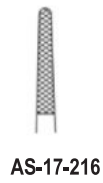

CRILE-WOOD
AS-17-217 - AS-17-218

AS-17-217
15 cm

AS-17-218
18 cm

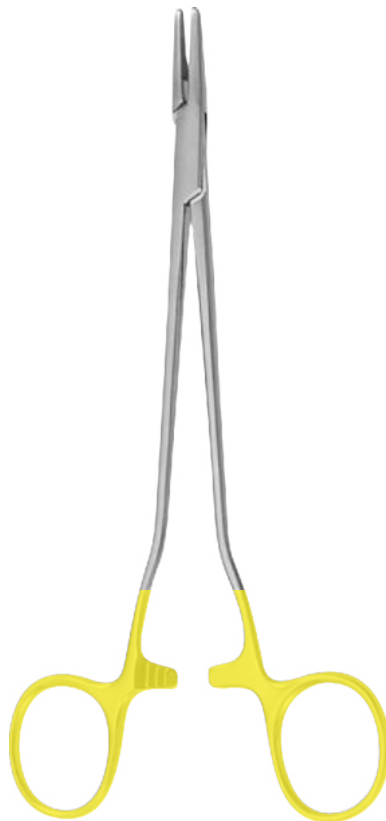

SAROT
AS-17-219 - AS-17-221





MAYO-HEGAR AS-17-222 - AS-17-227
AS-17-222 16 cm
AS-17-223 18 cm
AS-17-224 20 cm
AS-17-225 24 cm
AS-17-226 26 cm
AS-17-227 30 cm



MAYO-HEGAR (HEANEY) AS-17-228 - AS-17-230
AS-17-228 20 cm **AS-17-229** 24 cm **AS-17-230** 26 cm

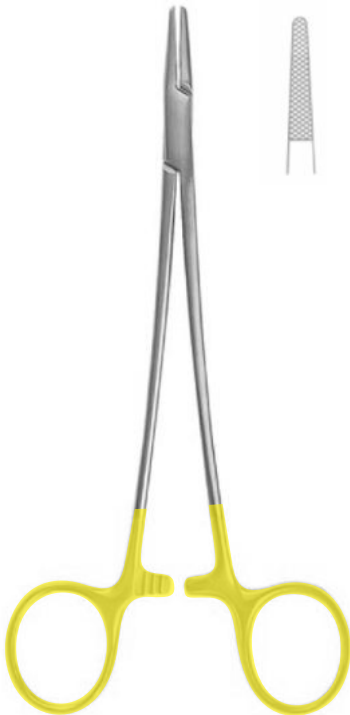

DE BAKEY AS-17-231 - AS-17-236
AS-17-231 18 cm
AS-17-232 20 cm
AS-17-233 23 cm
AS-17-234 26 cm
AS-17-235 31 cm
AS-17-236 37 cm

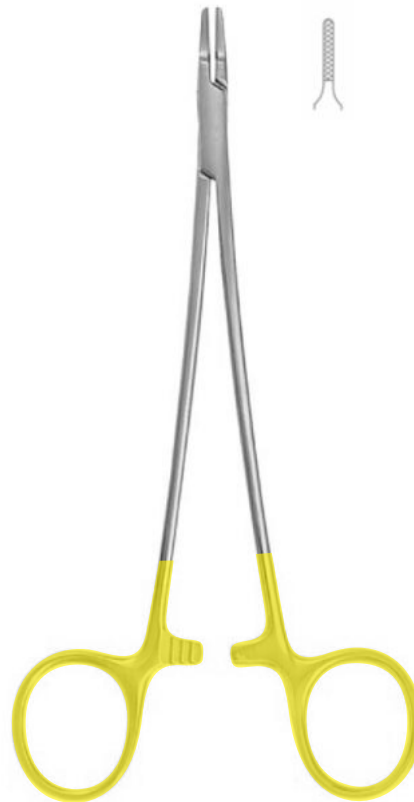

RYDER-VASCULAR AS-17-237 - AS-17-242
AS-17-237 13 cm
AS-17-238 15 cm
AS-17-239 18 cm
AS-17-240 20 cm
AS-17-241 23 cm
AS-17-242 26 cm

NEEDLE HOLDERS WITH TUNGSTEN CARBIDE INSERTS



ASAMAR
SURGICAL



RYDER
AS-17-243 - AS-17-248
AS-17-243 13 cm
AS-17-244 15 cm
AS-17-245 18 cm
AS-17-246 20 cm
AS-17-247 23 cm
AS-17-248 26 cm

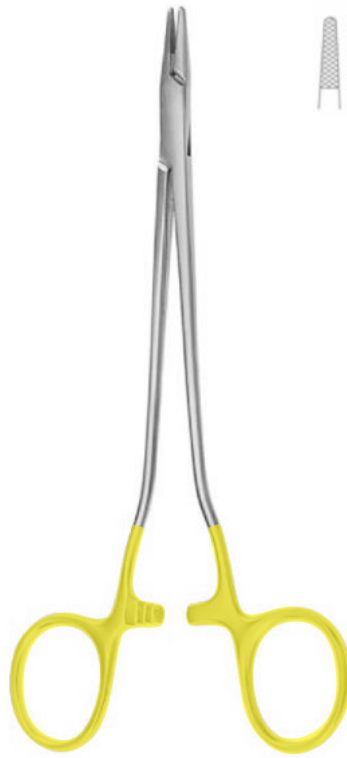

SCHWEDISCHES MODELL
AS-17-249 - AS-17-251
AS-17-249 15 cm
AS-17-250 17 cm
AS-17-251 20 cm

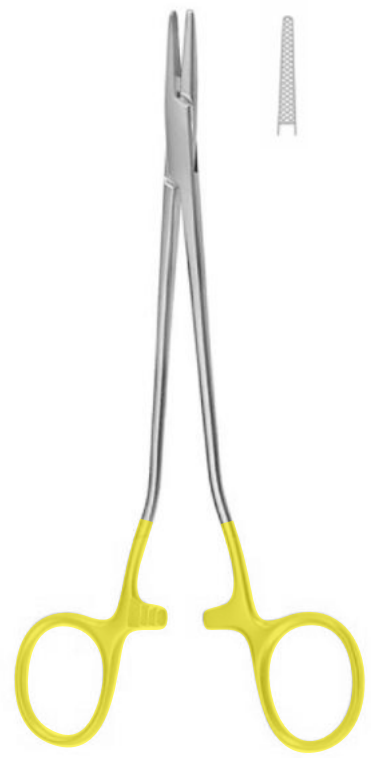

MAYO-HEGAR (HEANEY)
AS-17-252 - AS-17-255
AS-17-252 14 cm
AS-17-253 18 cm
AS-17-254 20 cm
AS-17-255 23 cm



FINOCCHIETTO
AS-17-256
 27 cm



MASSON
AS-17-257
 27 cm

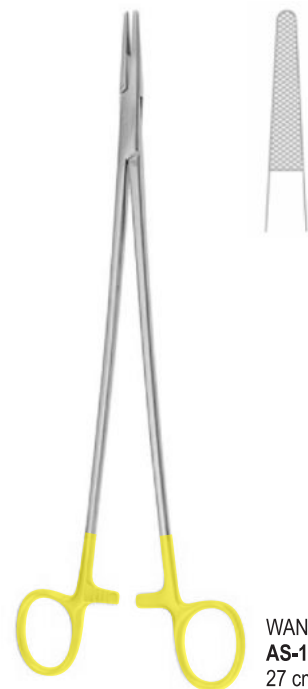

WANGENSTEEN
AS-17-258
 27 cm



BOZEMANN
AS-17-259 - AS-17-261
AS-17-259 20 cm
AS-17-260 24 cm
AS-17-261 26 cm



BERRY STERNAL
AS-17-262 - AS-17-263



AS-17-262
FOR STERNUM
SUTURE
15 cm

AS-17-263
WIRE
TWISTER
20 cm



HEGAR
AS-17-264 - AS-17-265
AS-17-264 20 cm
AS-17-265 24 cm



STRATTE
AS-17-266 - AS-17-
267 AS-17-266 22 cm
AS-17-267 23 cm



GILLIES
AS-17-268
16 cm



OLSEN-HEGAR AS-
17-269 - AS-17-271
AS-17-269 14 cm
AS-17-270 17 cm
AS-17-271 18 cm



TOENNIS
AS-17-272
18 cm

NEEDLE HOLDERS WITH TUNGSTEN CARBIDE INSERTS



LICHTENBERG AS-17-273 - AS-17-274
 AS-17-273 17 cm
 AS-17-274 20 cm



MATHIEU-KOCHER AS-17-275 - AS-17-277
 AS-17-275 14 cm
 AS-17-276 17 cm
 AS-17-277 20 cm



MATHIEU AS-17-278 - AS-17-280
 AS-17-278 14 cm
 AS-17-279 17 cm
 AS-17-280 20 cm



MATHIEU AS-17-281 - AS-17-283
 AS-17-281 14 cm
 AS-17-282 17 cm
 AS-17-283 20 cm



ZWEIFEL AS-17-284 - AS-17-285
 AS-17-284 20 cm
 AS-17-285 23 cm



LANGENBECK AS-17-286 - AS-17-288
 AS-17-286 18 cm
 AS-17-287 20 cm
 AS-17-288 23 cm

NEEDLE HOLDERS WITH TUNGSTEN CARBIDE INSERTS



CASTROVIEJO
AS-17-289 - AS-17-292
14.5 cm



AS-17-289



AS-17-290



AS-17-291



AS-17-292



CASTROVIEJO
AS-17-293 - AS-17-296
18 cm



AS-17-293



AS-17-294



AS-17-295



AS-17-296

NEEDLE HOLDERS WITH TUNGSTEN CARBIDE INSERTS



ASAMAR
SURGICAL



BARRAQUER
AS-17-297 - AS-17-300
14.5 cm



AS-17-297



AS-17-298



AS-17-299



AS-17-300



HEPP SCHEIDEL
AS-17-301
18 cm



ASAMAR
SURGICAL 

PAGE

396-406

**GALL BLADER, LIVER
AND SPLEEN INSTRUMENTS
GENITO URINARY INSTRUMENTS**

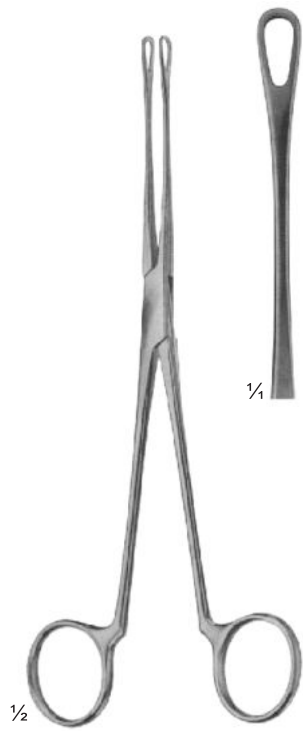

AS-18-101
BLAKE 205
mm

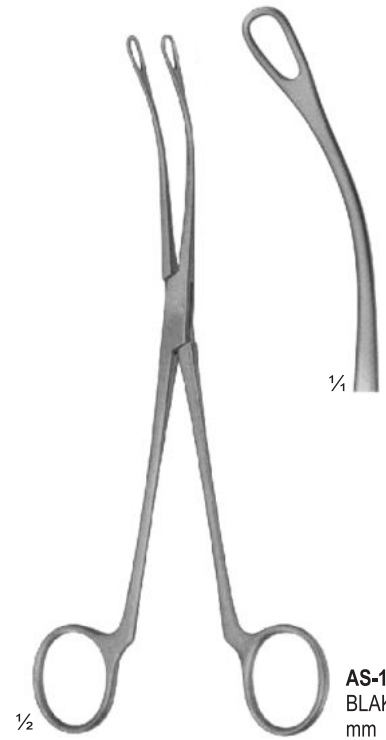

AS-18-102
BLAKE 205
mm

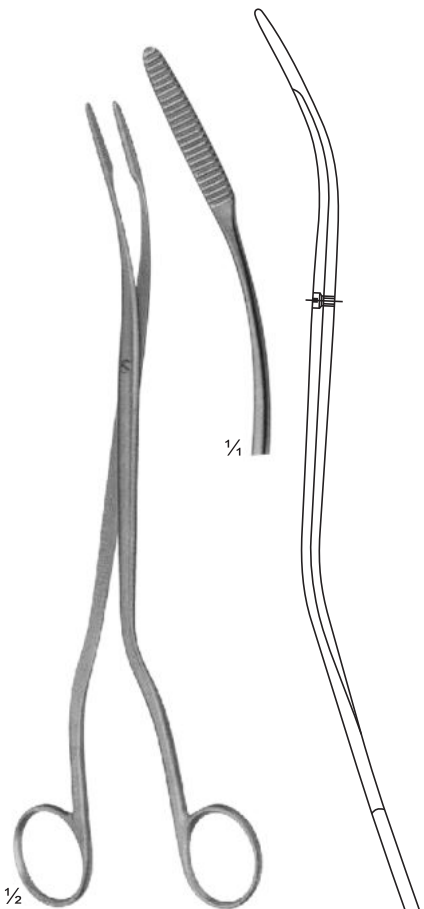

AS-18-103
CZERNY
245 mm



AS-18-104 - AS-18-107
DESJARDINS
225 mm

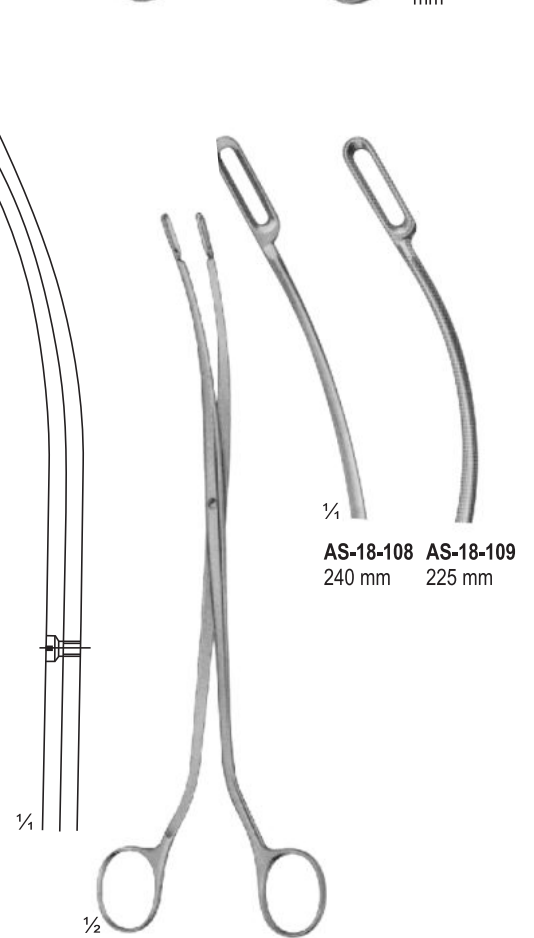



AS-18-110



AS-18-114



AS-18-111



AS-18-115



1/2

AS-18-110 - AS-18-113
RANDALL
225 mm



AS-18-112



1/4
AS-18-116



1/4
AS-18-113



1/2

AS-18-114 - AS-18-116
RANDALL
190 mm

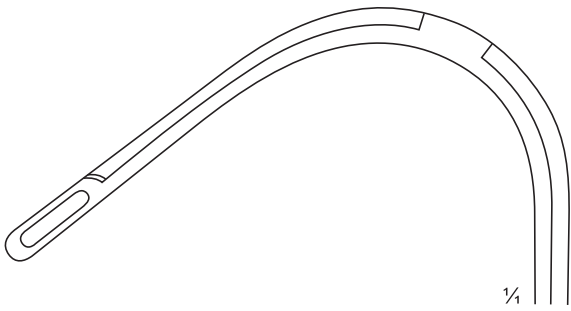

Fig. 1
AS-18-117
230 mm

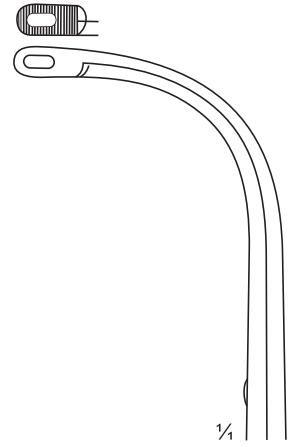

Fig. 1
AS-18-119
160 mm

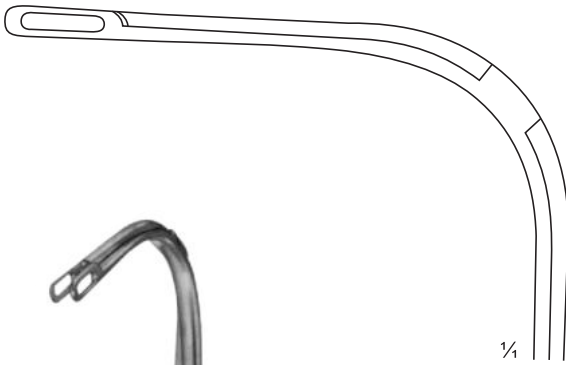

Fig. 2
AS-18-118
240 mm

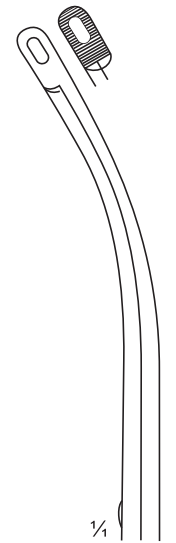

Fig. 1
AS-18-120
170 mm



RANDALL
AS-18-117 - AS-18-118



HEIMING
AS-18-119 - AS-18-120



1/2

ELSÄSSER
AS-18-121 - AS-18-122
210 mm

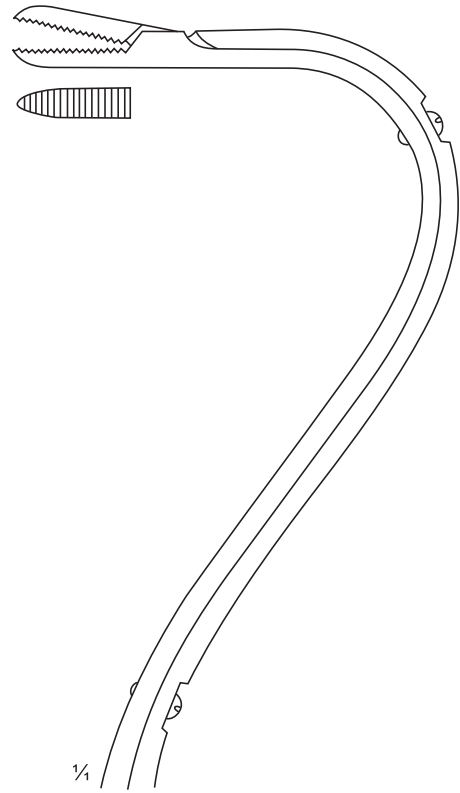

1/4

Fig. 1
AS-18-121

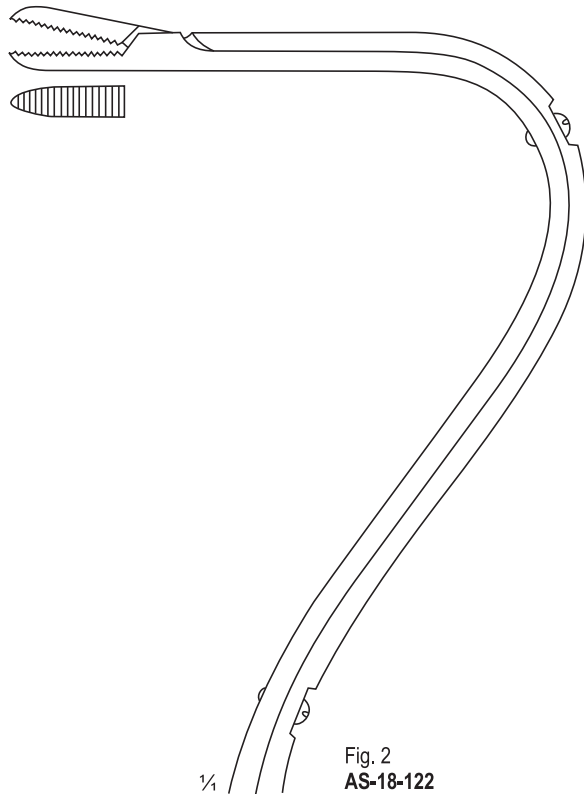

1/4

Fig. 2
AS-18-122

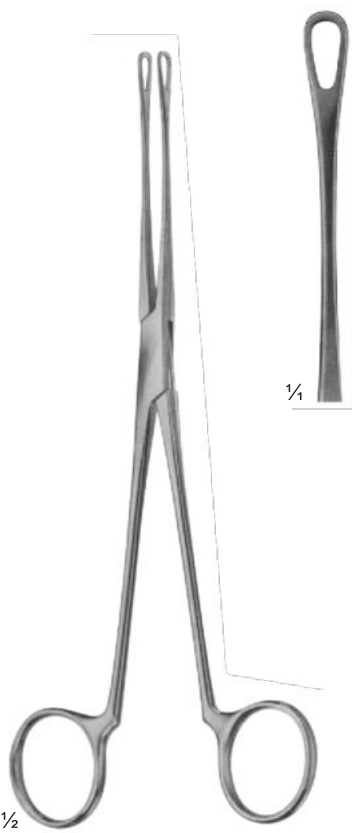

BLAKE
AS-18-123
205 mm

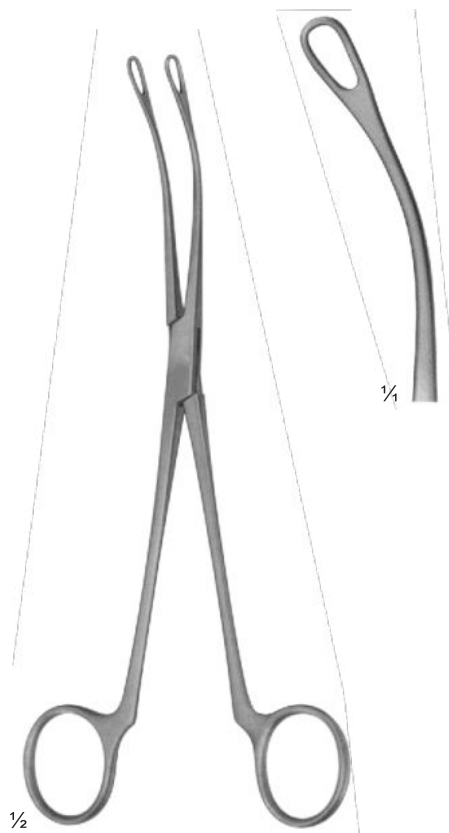

BLAKE
AS-18-124
205 mm



MAYO-BLAKE
AS-18-125
210 mm



MAYO-BLAKE
AS-18-126
210 mm

ATRAUMA



MILLIN
Lobe grasping forceps
AS-18-127
235 mm

ATRAUMA

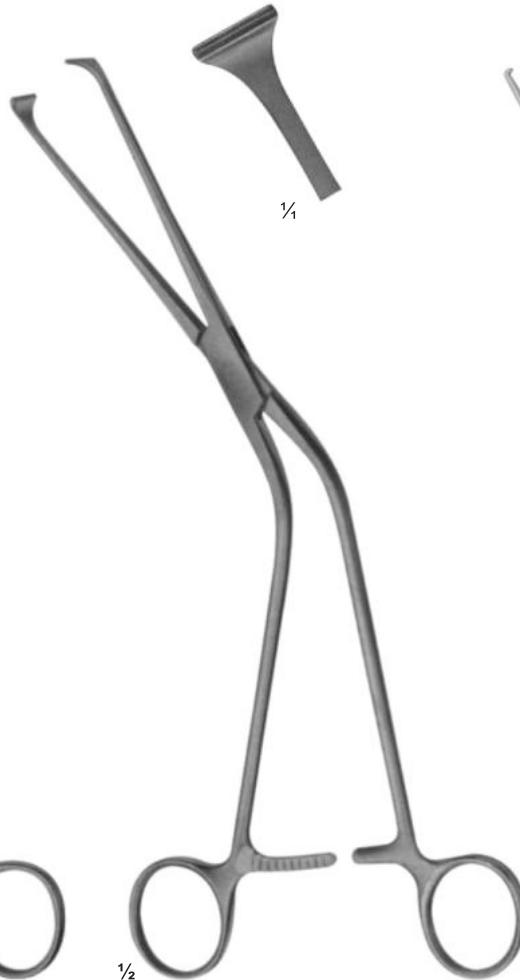

MILLIN
Lobe grasping forceps
AS-18-128
245 mm



MILLIN
Ligature holding forceps
AS-18-129
245 mm



1/2

LEGUEU
AS-18-130
270 mm



1/2

KOCHER
AS-18-131
260 mm



1/2

KOCHER
AS-18-132
260 mm

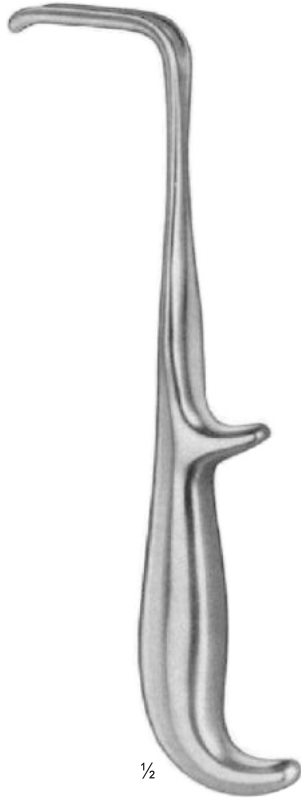

YOUNG
AS-18-133
210 mm

½



YOUNG
AS-18-134
220 mm

½



YOUNG
AS-18-135
210 mm

½



YOUNG
AS-18-136
220 mm

½

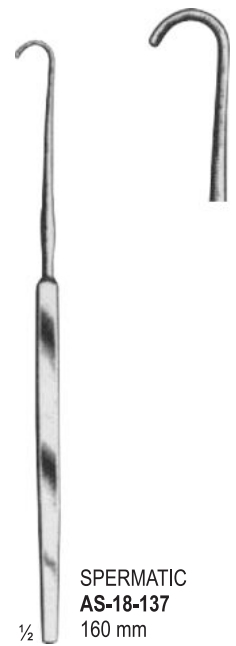

SPERMATIC
AS-18-137
160 mm

½

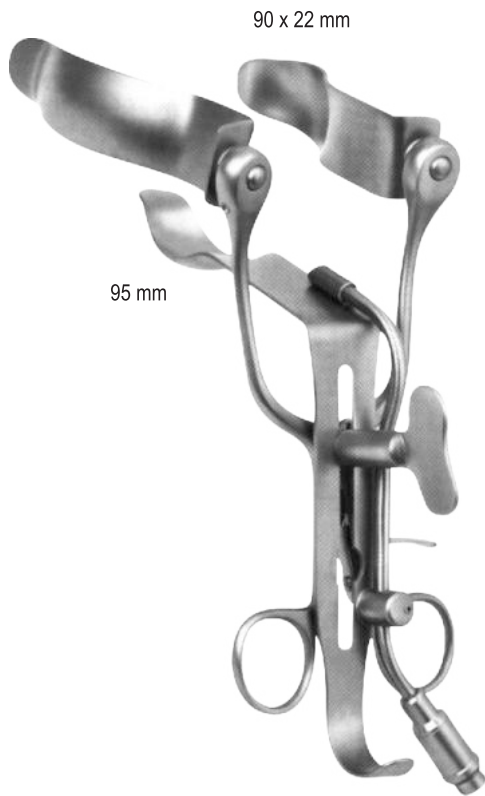

ALAN-PARKS
AS-18-138
150 mm

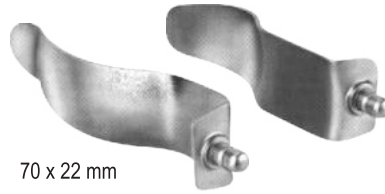

FIBER OPTIC
AS-18-139



ALAN-PARKS
AS-18-140
150 mm

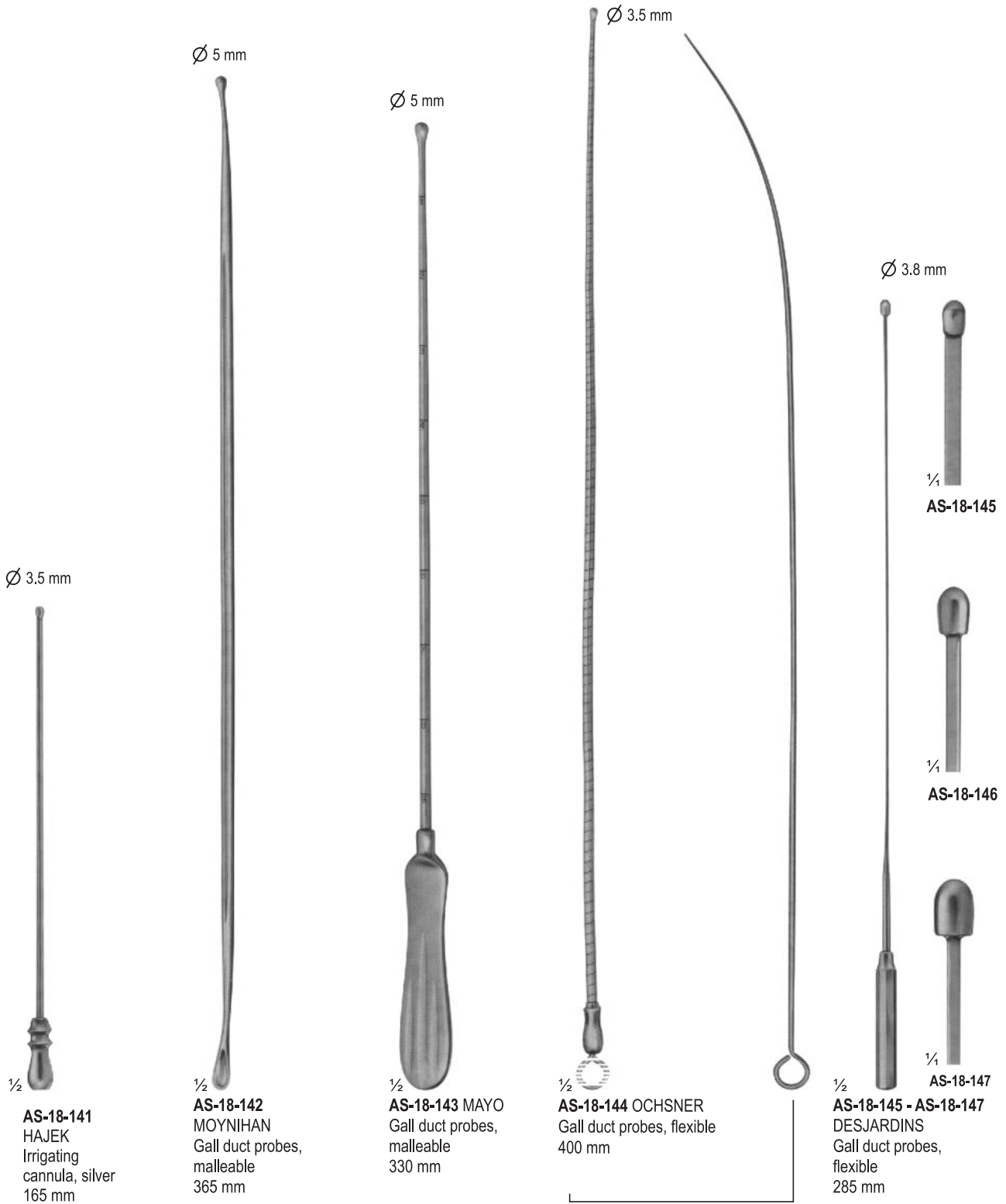

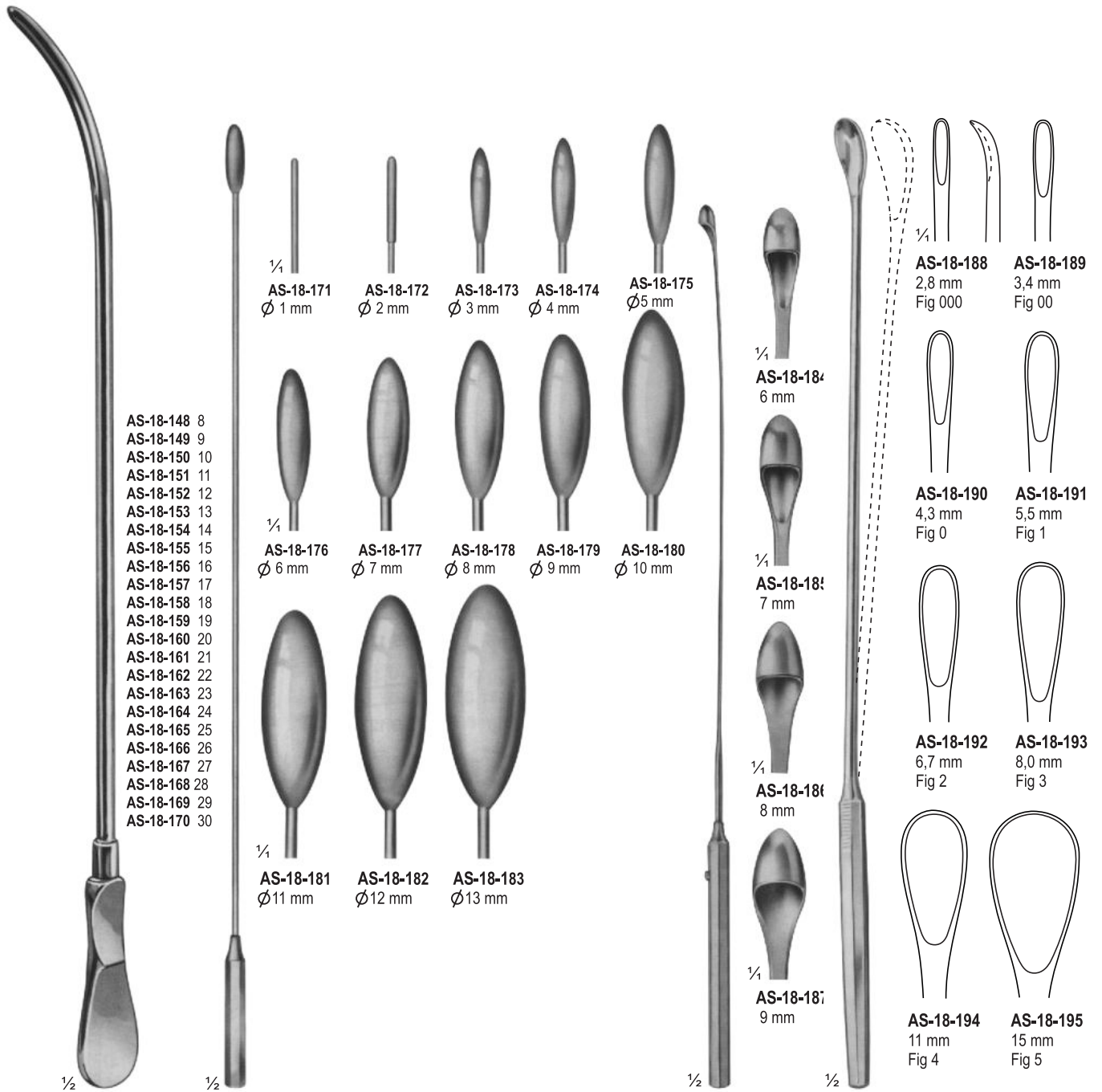

AS-18-148 - AS-18-170
DITTEL
Metall bougies and
dilating sounds, stiff
345 mm

AS-18-171 - AS-18-183
BAKES
Common bile duct
dilators, malleable
315 mm, 320 mm

AS-18-184 - AS-18-187
DESJARDINS
Probes and catch
with flexible shaft
300 mm

AS-18-188 - AS-18-195
LUER-KORTE modif with
malleable shaft 310 mm



ASAMAR
SURGICAL 

PAGE

407-463

MALLETS
TEMPERS, CHISELS, GOUGES
BONE HOLDING FORCEPS
RONGEURS
BONE CUTTING FORCEPS
MENISCUS INSTRUMENTS
WIRE EXTENSION
HAND DRILLS, AWLS
REAMERS
BONE BIOPSY INSTRUMENTS
FINGER NAIL INSTRUMENTS

TENDON HOLDING FORCEPS, TENDON TUNNELING FORCEPS



ASAMAR
SURGICAL

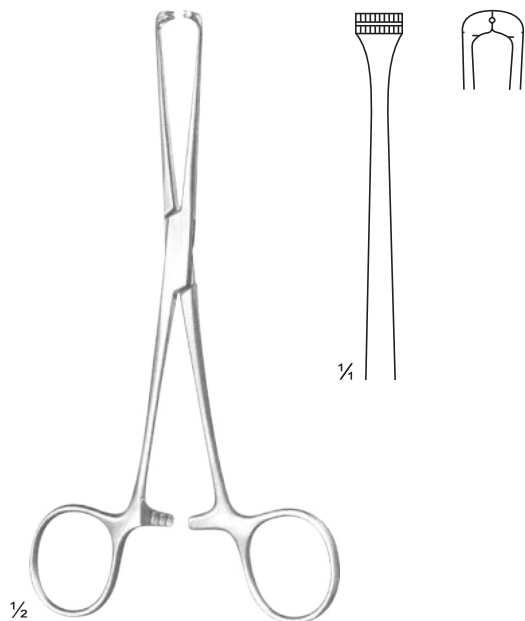

STEINMANN
AS-19-101
160 mm

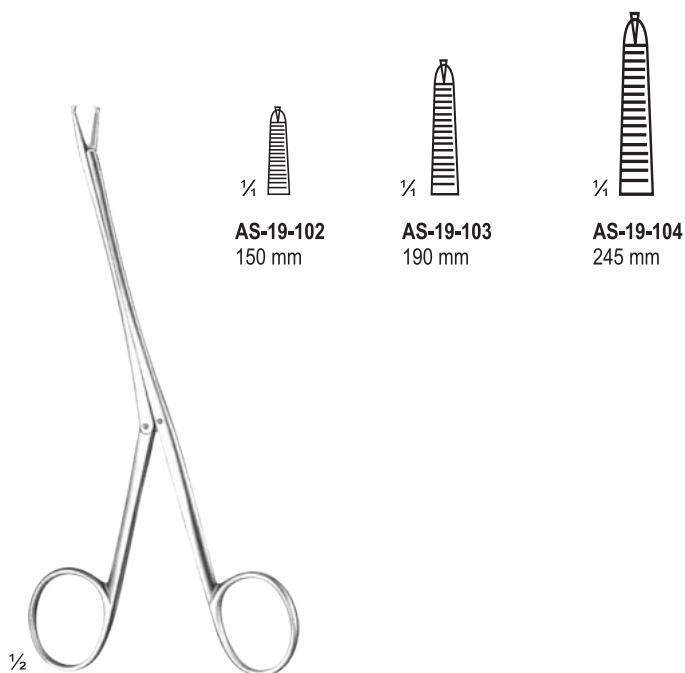

BRAND
AS-19-102 - AS-19-104

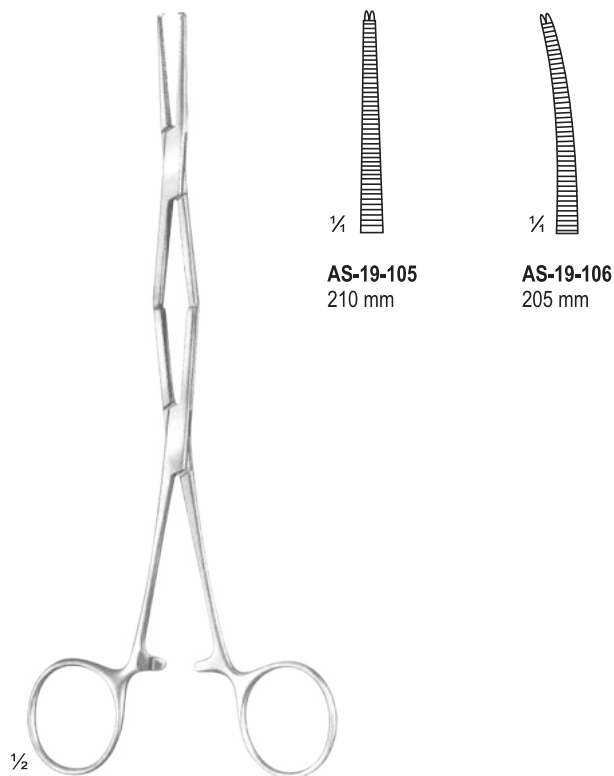

AS-19-105 - AS-19-106

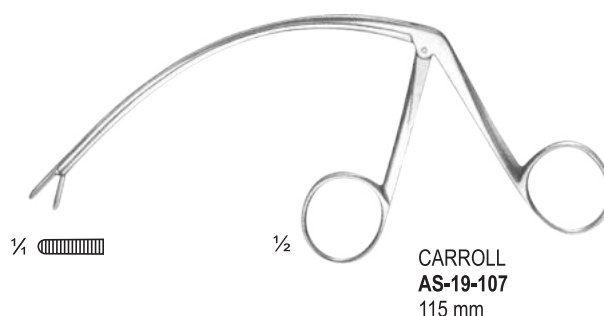

CARROLL
AS-19-107
115 mm

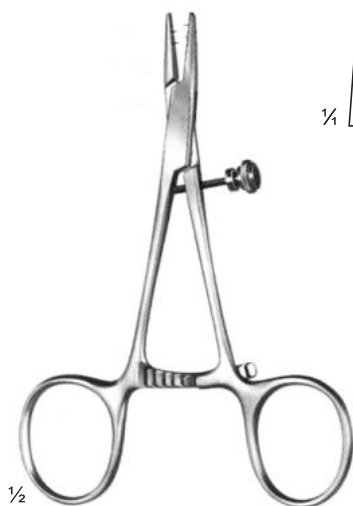

1/2
AS-19-108
115 mm

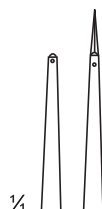

1/2
AS-19-109
150 mm

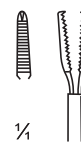

1/2
KLEINERT-KUTZ
AS-19-110
210 mm
Shaft Length
140 mm

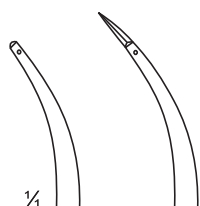

1/2
AS-19-111
150 mm

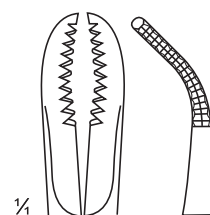

1/2
AS-19-112
145 mm
Bone Holding
Forceps



Repositioning forceps,
for small fragments
AS-19-113
135 mm

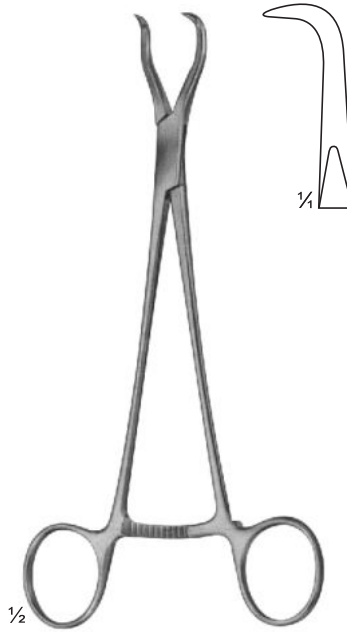

HAASE
Repositioning
forceps, for
mandibular fractures
AS-19-114
165 mm

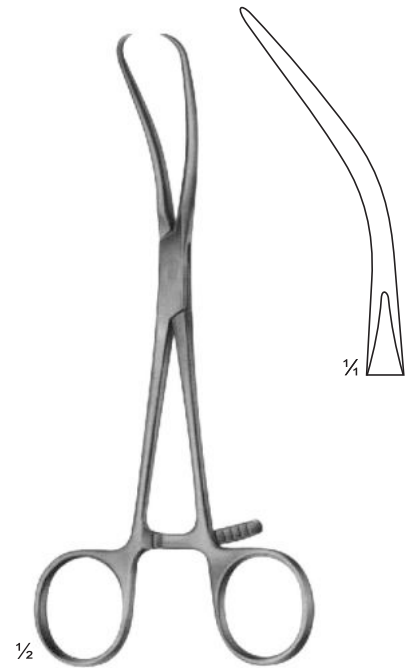

REILL
Repositioning
forceps, **AS-19-115**
170 mm

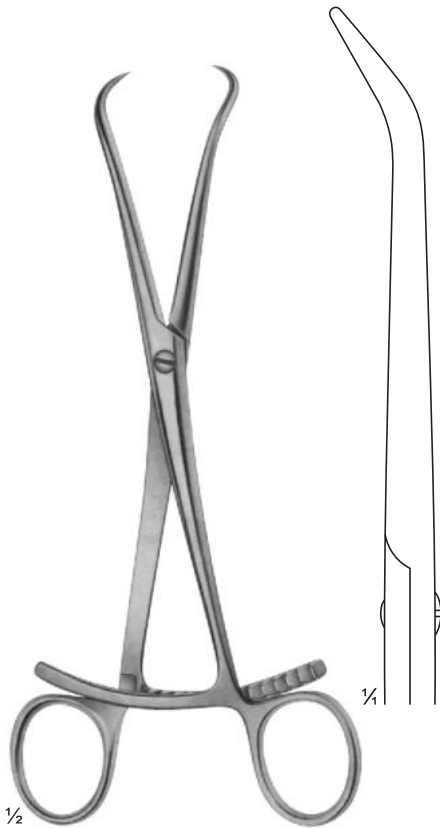

Repositioning forceps
AS-19-116
205 mm

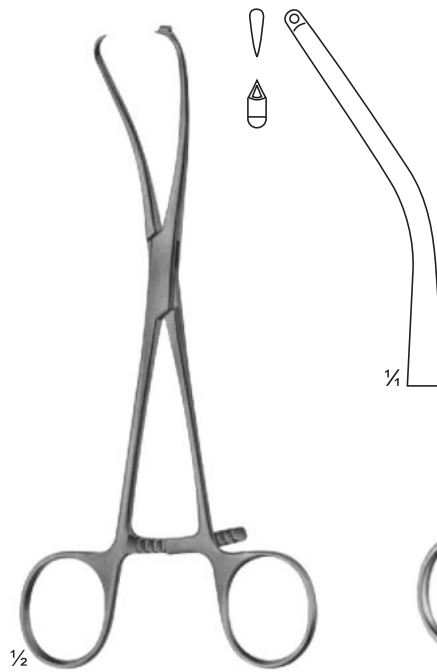

MEYER AS-19-117
Repositioning forceps
for fingers, with drill guide for
KIRSCHNER wires up to
daim.1.0 mm 17 cm

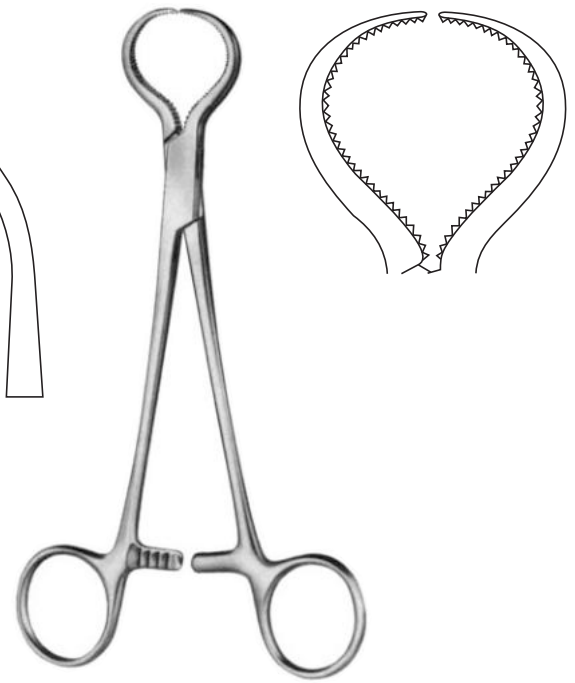

LEWIN
AS-19-118
180 mm



**PATELLA FORCEPS
AS-19-119**
185 mm

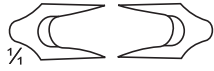

**Forceps with
ratchet
fixation AS-
19-120**
140 mm



AS-19-121
120 mm



**SETTER
AS-19-122**
135 mm



**SETTER
AS-19-123**
170 mm



**SETTER
AS-19-124**
235 mm

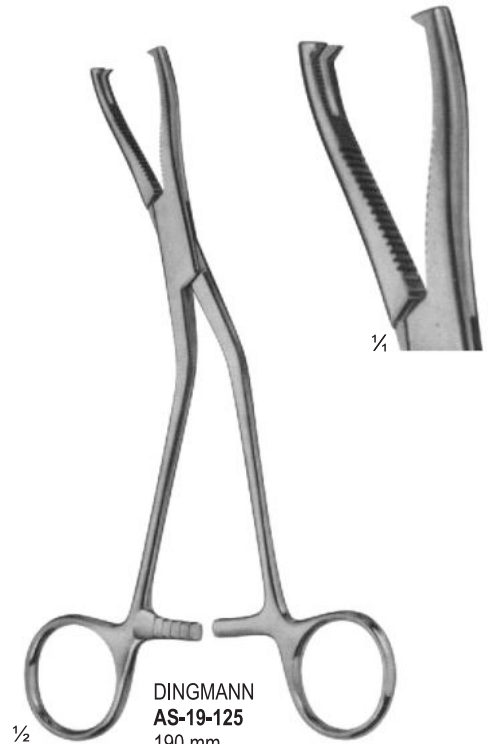

**DINGMANN
AS-19-125**
190 mm

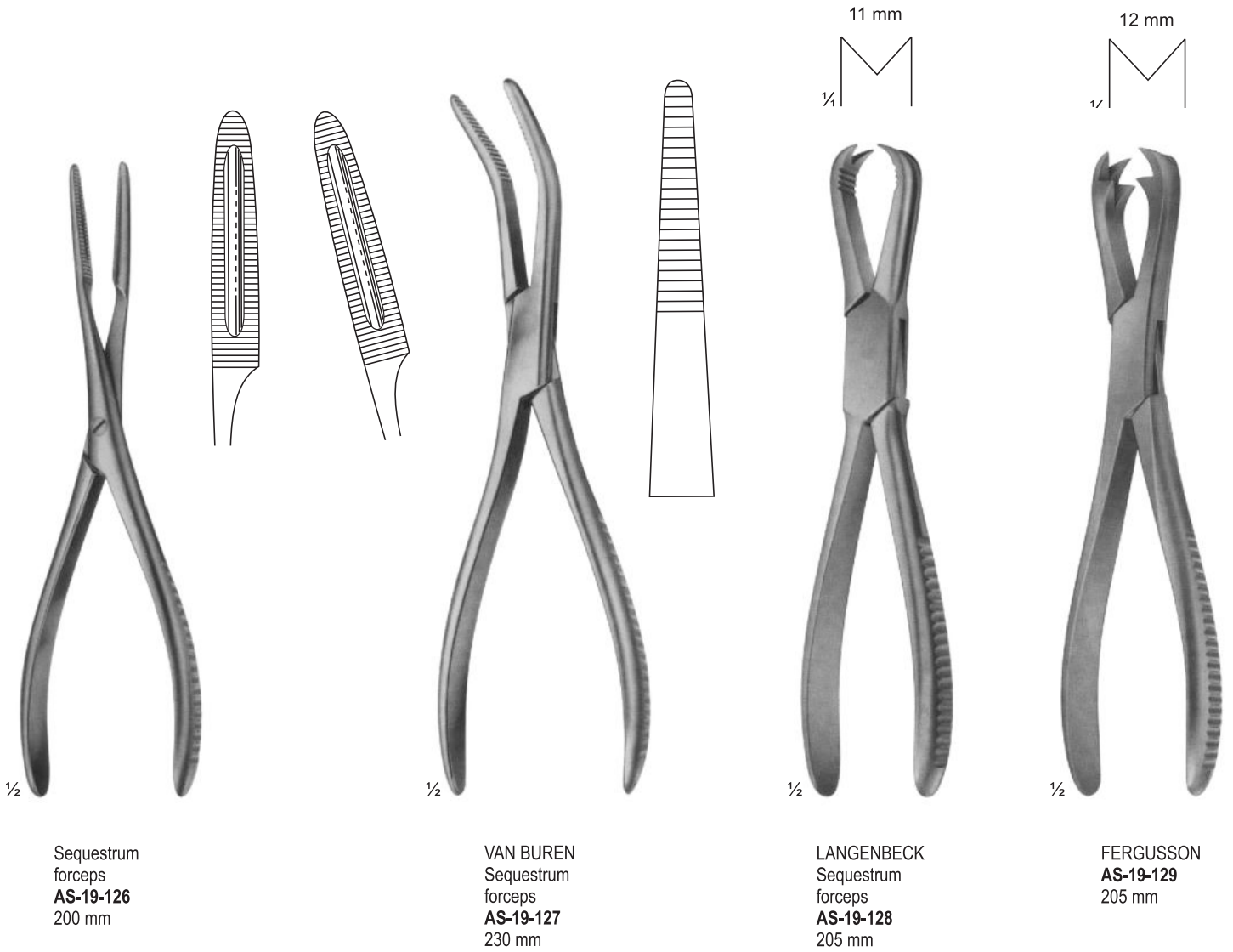

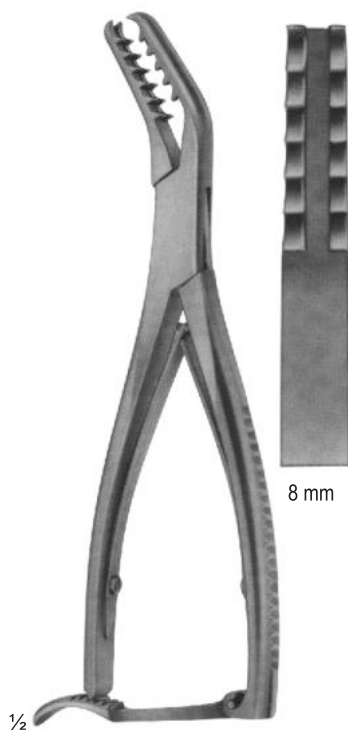

SEM B
AS-19-130
190 mm

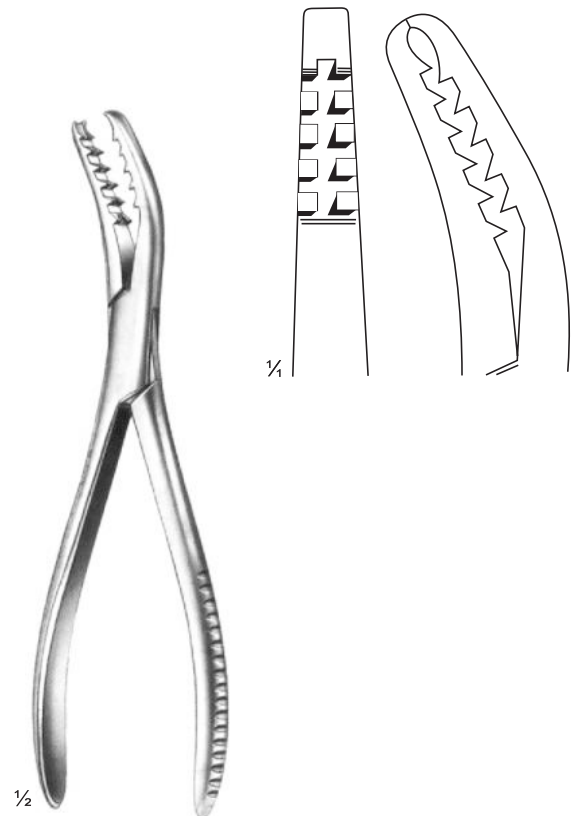
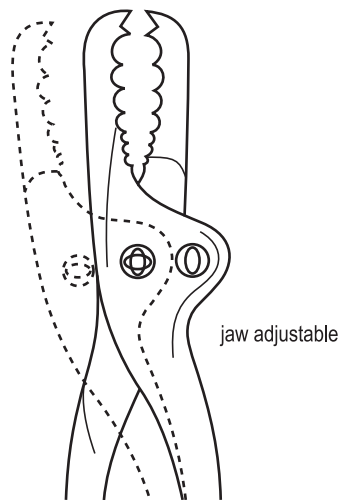

SEM B
AS-19-131
195 mm

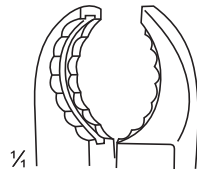
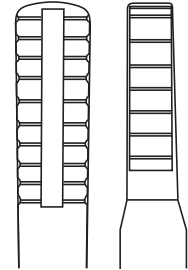
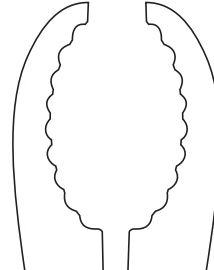
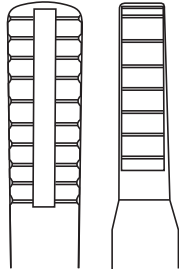
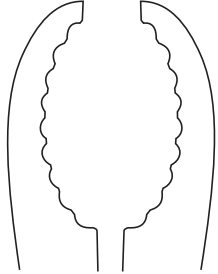

AS-19-132
230 mm

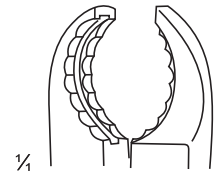

AS-19-135
230 mm

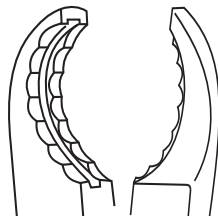

AS-19-133
250 mm

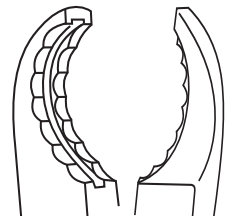

AS-19-136
250 mm

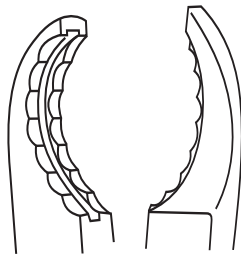

AS-19-134
280 mm

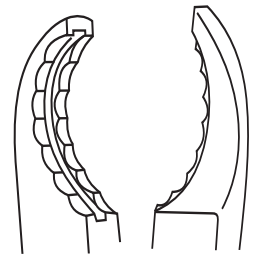

AS-19-137
270 mm



ULRICH
AS-19-135 - AS-19-137
With thread Fixation

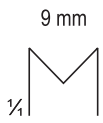

FARABEU
AS-19-138
230 mm

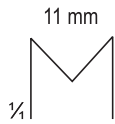

FARABEU
AS-19-139
255 mm

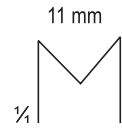

FARABEU-LAMBOTTE
AS-19-140
255 mm

MENISCUS & CARTILAGE FORCEPS



ASAMAR
SURGICAL

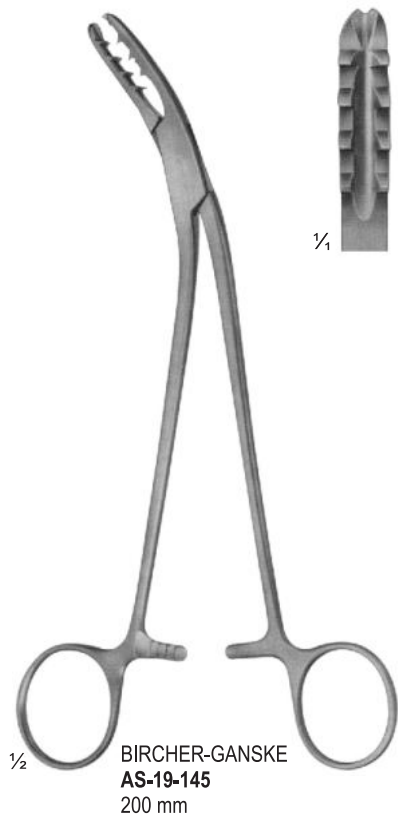
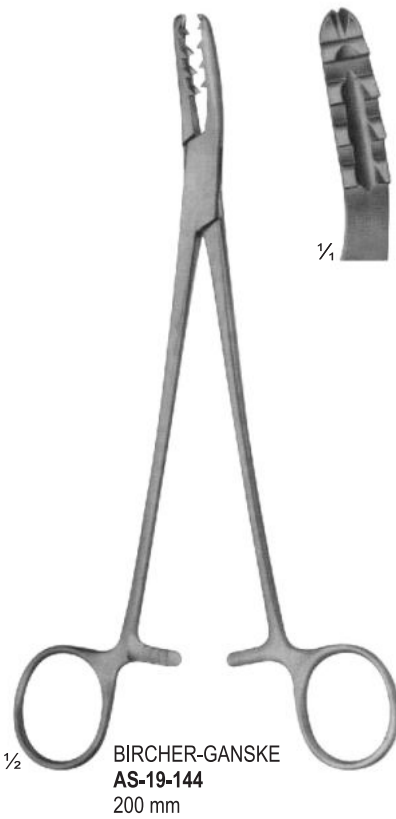
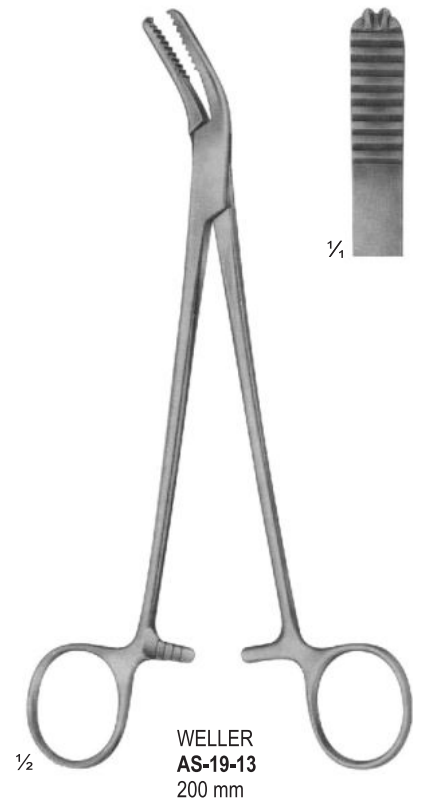



∅ 20 mm

1/2

AS-19-147 MEAD
185 g
with interchangeable
plastic disks
190 mm
pair of spare disks



1/2

AS-19-148
140 g
with interchangeable
plastic disks
185 mm
AS-19-149
pair of spare disks



∅ 25 mm

1/2

AS-19-150
COTTLE 140 g
1 Seite convex
1 Side convex
185 mm



∅ 22 mm

1/2

AS-19-151
165 g
lead filled
head 190 mm

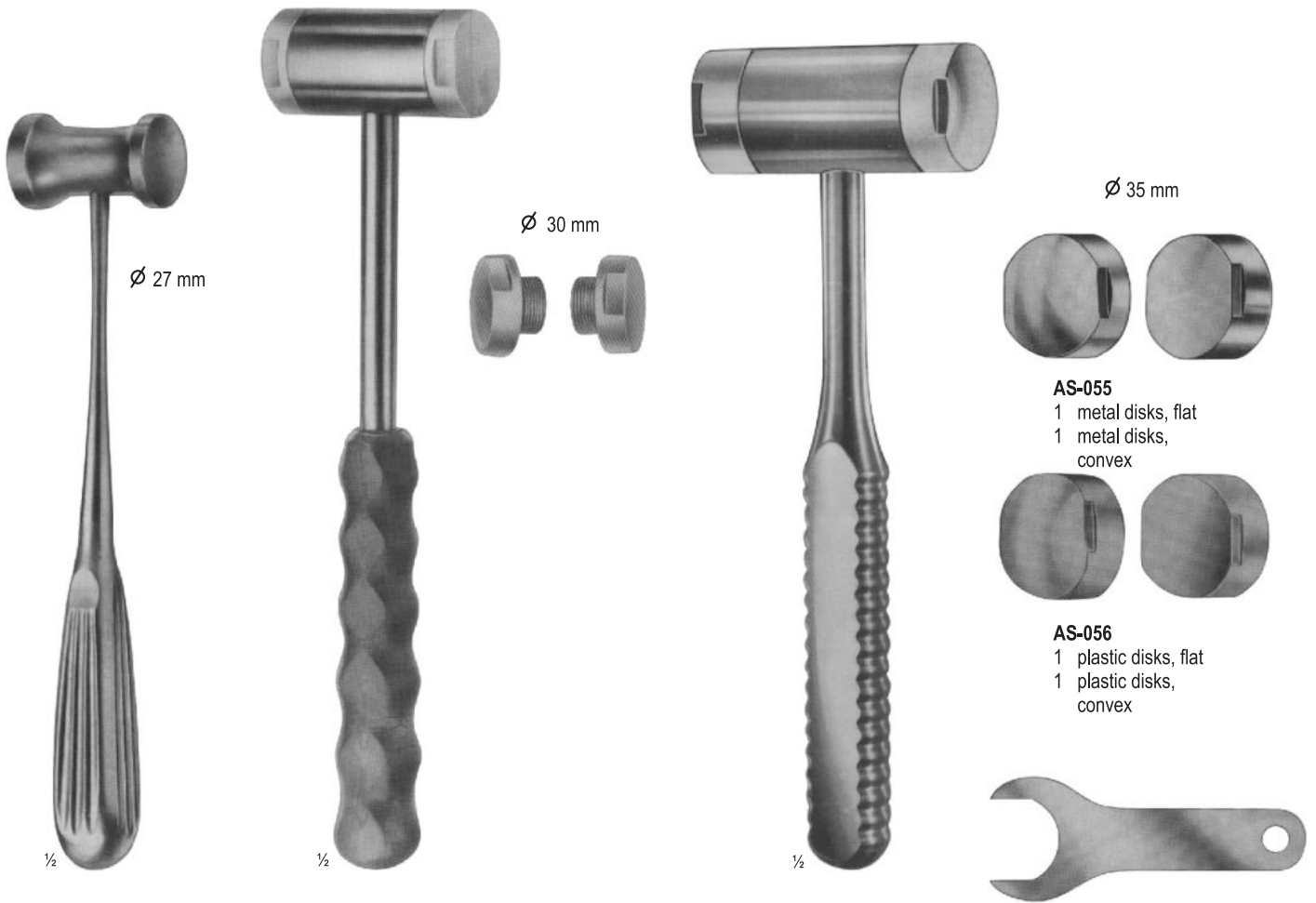

HAJEK 140 g
AS-19-152
215 mm

AS-053
215 g
with interchangeable plastic
disks
245 mm
AS-054
pair of spare disks

WAGNER complete with:
1 pair of metal disks and
1 pair of plastic disks and wrench 566
AS-055 - AS-057
235 mm

Wrench
AS-057
Mallet without disks 130 g



BERGMANN
AS-19-158
245 mm



BERGMANN
AS-19-159
235 mm



OMBREDANNE
AS-19-160
240 mm

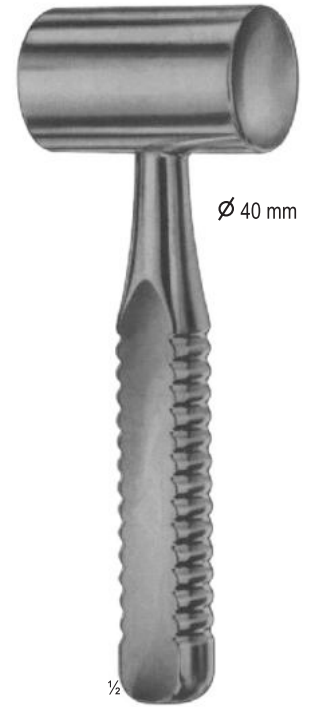

HEATH
copper filled head
700 g
AS-19-161
185 mm



WILLIGER
AS-19-162 - AS-19-164
 Lead Filled

AS-19-162	
Weight	Head
275 g	∅ 26 mm
AS-19-163	
Weight	Head
320 g	∅ 28 mm
AS-19-164	
Weight	Head
340 g	∅ 30 mm



DOYEN
AS-19-165 - AS-19-167

AS-19-165	
Weight	Head
120 g	∅ 25 mm
AS-19-166	
Weight	Head
180 g	∅ 30 mm
AS-19-167	
Weight	Head
260 g	∅ 35 mm



½

PARTSCH
AS-19-168
With Hollow
Handle 190 mm

Weight Head
175 g Ø27 mm



VIKERS
AS-19-169
190 mm

Weight Head
185 g Ø25 mm



HERBERT
AS-19-170
For Ulna Head
Prosthesis 190 mm

Weight Head
215 g Ø25 mm

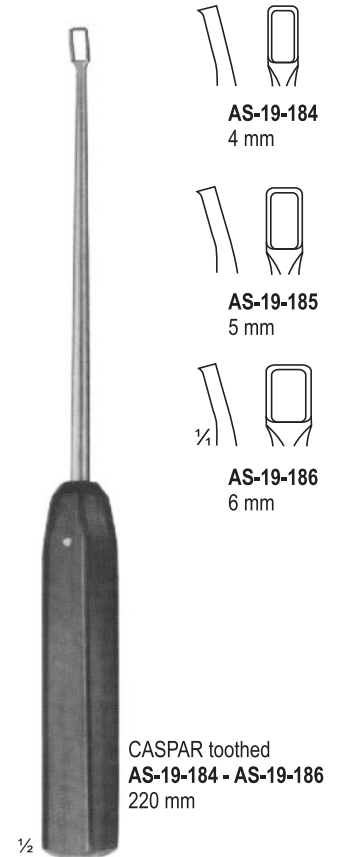
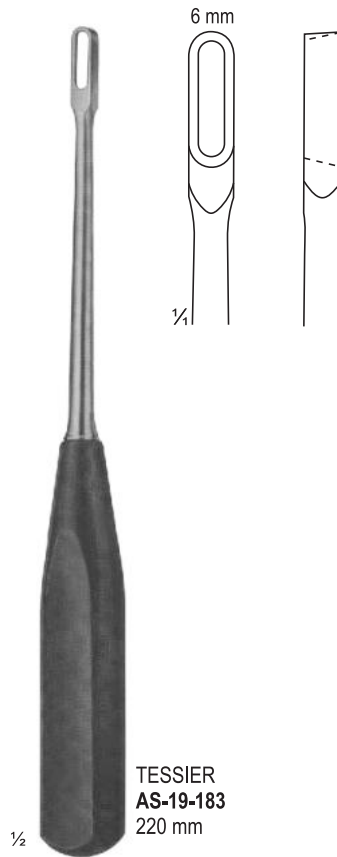
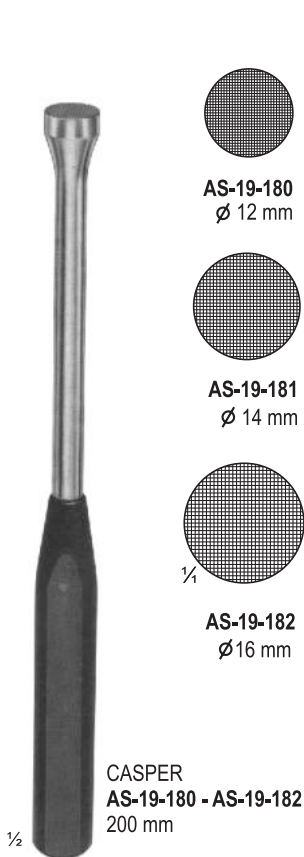
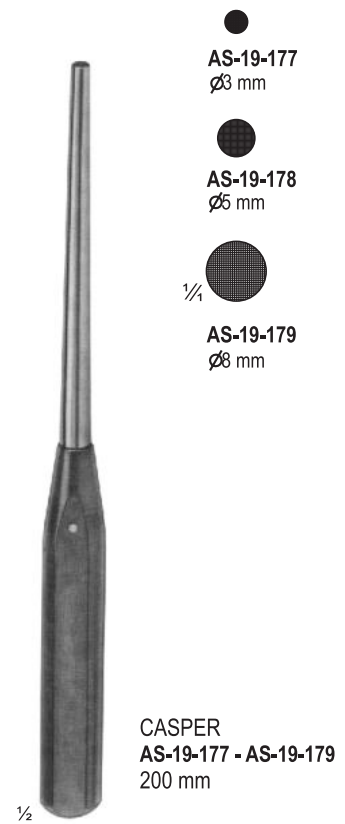
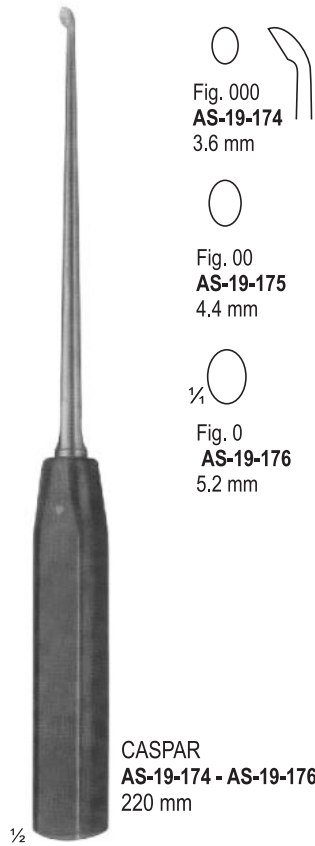
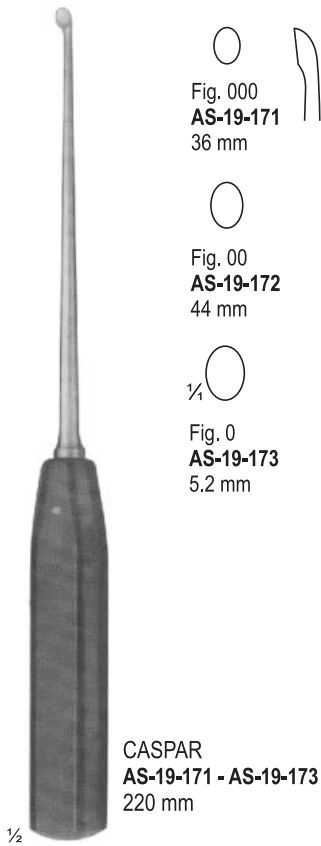

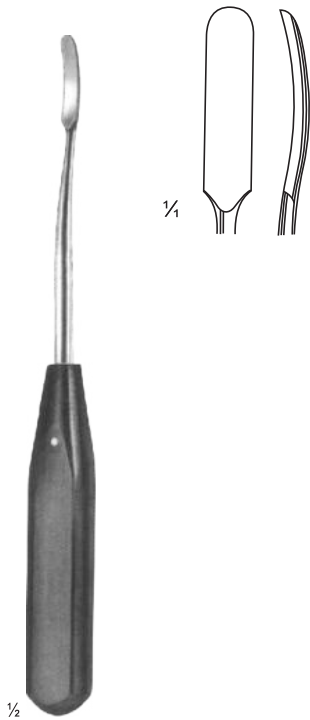

AS-19-187
180 mm
6 mm

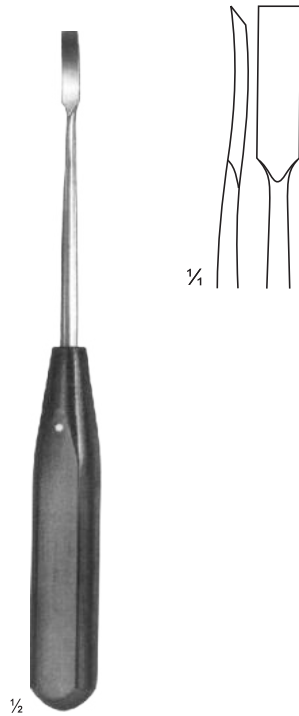

AS-19-188
180 mm
6 mm

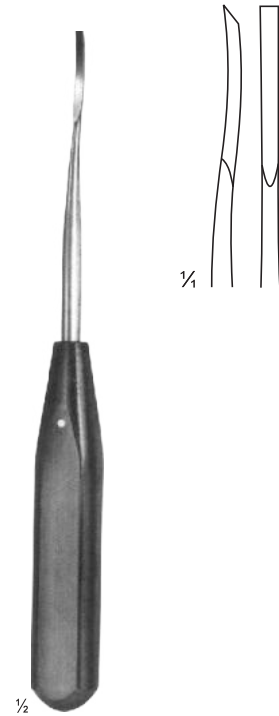

AS-19-189
180 mm
3 mm

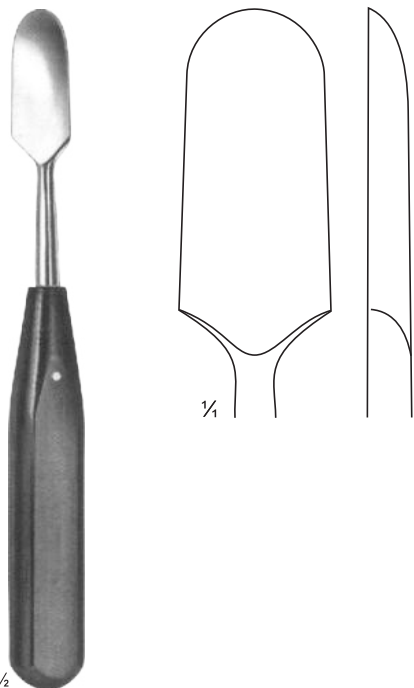

AS-19-190
180 mm
20 mm

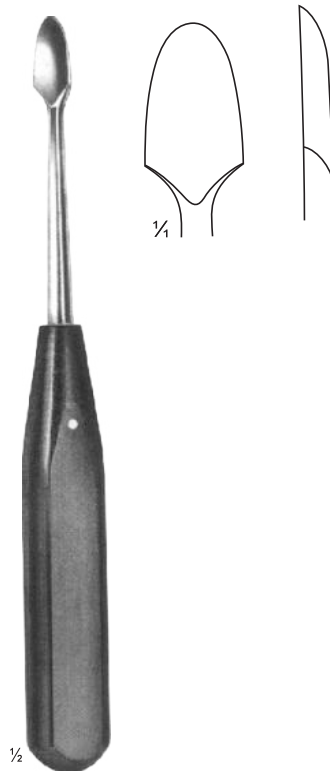

AS-19-191
200 mm
14 mm

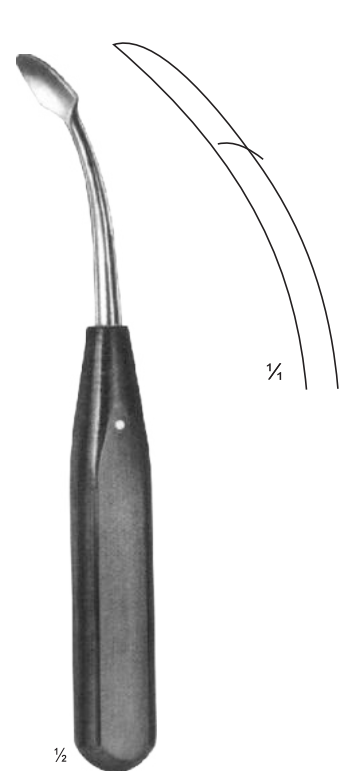

AS-19-192
190 mm
14 mm

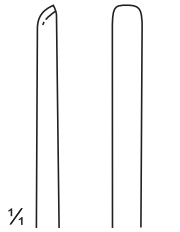

AS-19-193 5 mm
 AS-19-194 10 mm
 AS-19-195 15 mm

1/2

LEXER
 AS-19-193 - AS-19-195
 245 mm

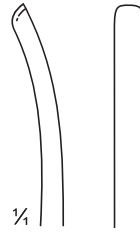

AS-19-196 5 mm
 AS-19-197 10 mm
 AS-19-198 15 mm

1/2

LEXER
 AS-19-196 - AS-19-198
 245 mm

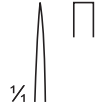

AS-19-199 4 mm
 AS-19-200 6 mm
 AS-19-201 8 mm
 AS-19-202 10 mm
 AS-19-203 12 mm

1/2

LEXER-MINI
 AS-19-199 - AS-19-203
 180 mm

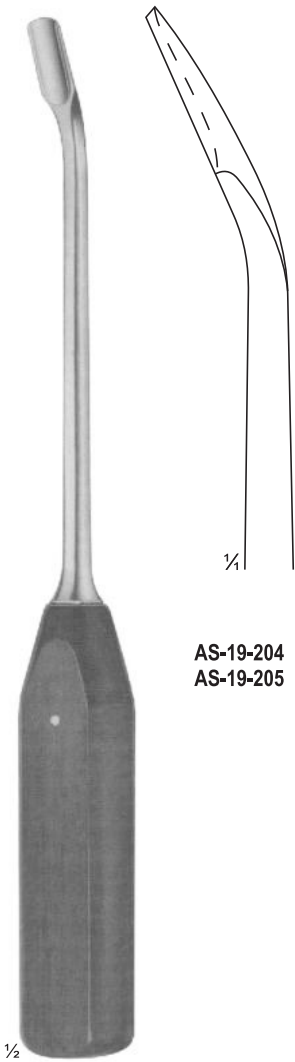

AS-19-204 10 mm
AS-19-205 15 mm

LEXER
AS-19-204 - AS-19-205
Gouges, angled
275 mm

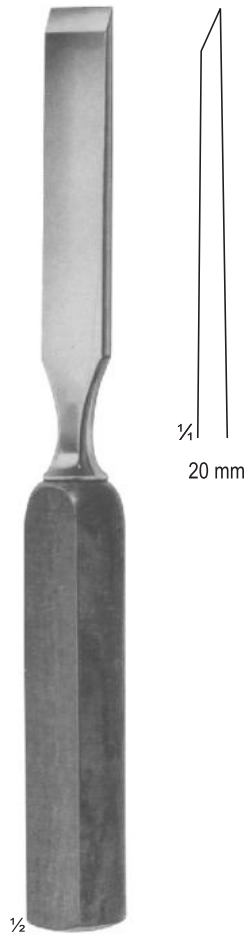

Chisel
AS-19-206
245 mm

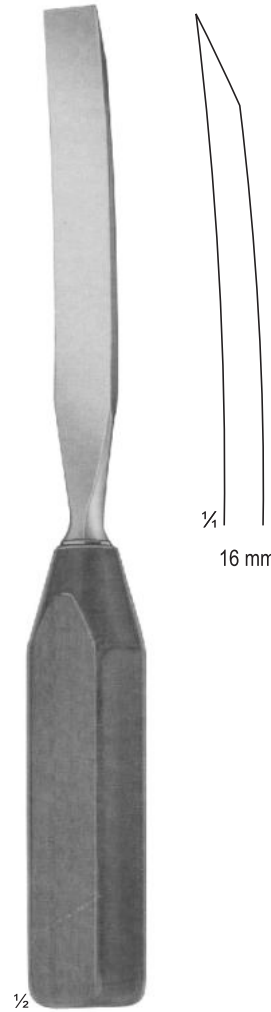

Chisel
curved
AS-19-207
265 mm

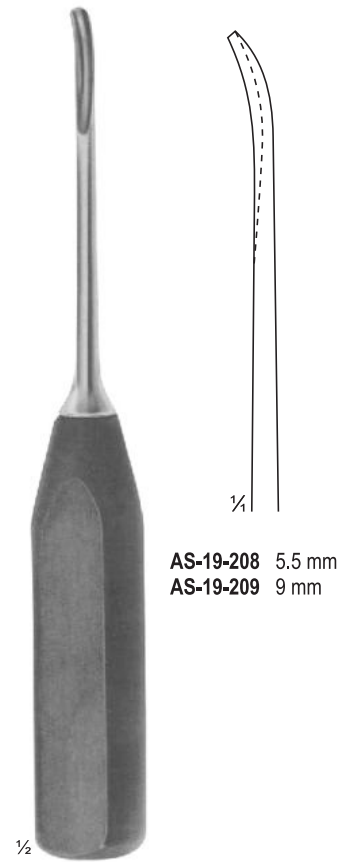

AS-19-208 5.5 mm
AS-19-209 9 mm

ZIELKE
AS-19-208 - AS-19-209
Gouge for scoliose-
operations 230 mm



1/2

AS-19-210 - AS-19-213
270 mm

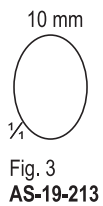
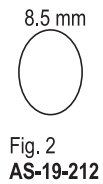
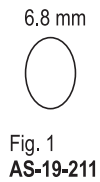
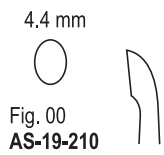

1/2

SYPERT
AS-19-214 - AS-19-221
380 mm

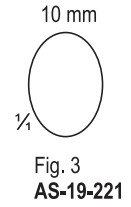
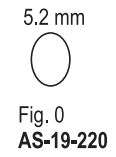
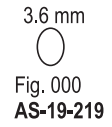
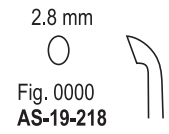
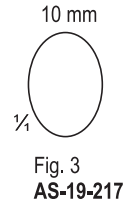
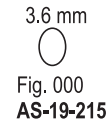
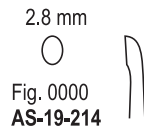

OSTEOTOMES, CHISELS & GOUGES WITH HANDLE

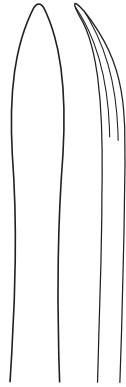

AS-19-222
200 mm

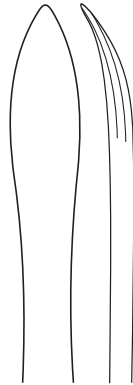

AS-19-223
200 mm

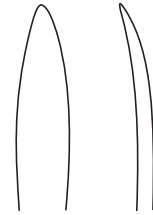

QUERVAIN
AS-19-224
200 mm

LANGENBECK
AS-19-222 - AS-19-223



AS-19-225
28 cm



AS-19-226
280 mm



AS-19-227
280 mm

COBB
AS-19-225 - AS-19-227



AS-19-228 - AS-19-233
AS-19-228 170 mm
AS-19-229 170 mm
AS-19-230 170 mm
AS-19-231 170 mm
AS-19-232 190 mm
AS-19-233 190 mm



- AS-19-234**
3 mm
- AS-19-235**
5 mm
- AS-19-236**
6 mm
- AS-19-237**
8 mm
- AS-19-238**
9 mm

HOKE
AS-19-234 - AS-19-238
170 mm



- AS-19-239**
6 mm
- AS-19-240**
13 mm
- AS-19-241**
19 mm
- AS-19-242**
25 mm
- AS-19-243**
32 mm

HIBBS
AS-19-239 - AS-19-243
245 mm



- AS-19-244**
6 mm
- AS-19-245**
13 mm
- AS-19-246**
19 mm
- AS-19-247**
25 mm
- AS-19-248**
32 mm

HIBBS
AS-19-244 - AS-19-248
245 mm



- AS-19-249
6 mm
- AS-19-250
9 mm
- AS-19-251
13 mm
- AS-19-252
16 mm
- AS-19-253
19 mm
- AS-19-254
25 mm
- AS-19-255
32 mm

1/2

SMITH-PETERSEN
AS-19-249 - AS-19-255
205 mm



- AS-19-256
6 mm
- AS-19-257
9 mm
- AS-19-258
13 mm
- AS-19-259
16 mm
- AS-19-260
19 mm
- AS-19-261
25 mm
- AS-19-262
32 mm

1/2

SMITH-PETERSEN
AS-19-256 - AS-19-262
205 mm



- AS-19-263
9 mm
- AS-19-264
14 mm
- AS-19-265
19 mm
- AS-19-266
25 mm

1/2

SMITH-PETERSEN
AS-19-263 - AS-19-266
205 mm



- AS-19-267
9 mm
- AS-19-268
14 mm
- AS-19-269
19 mm
- AS-19-270
25 mm

1/2

SMITH-PETERSEN
AS-19-267 - AS-19-270
205 mm

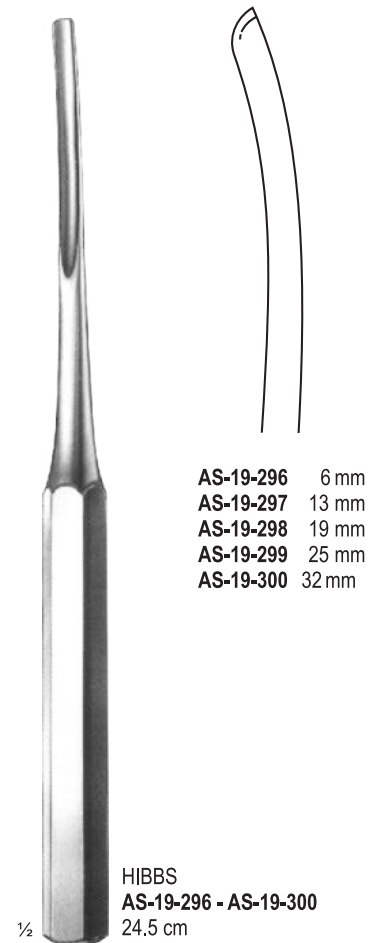
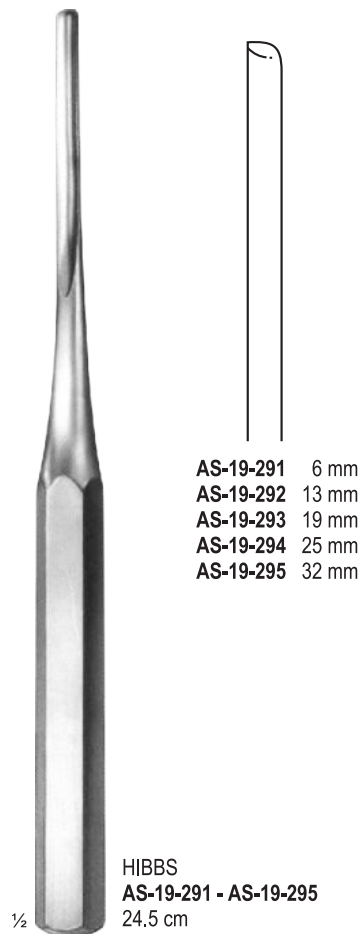
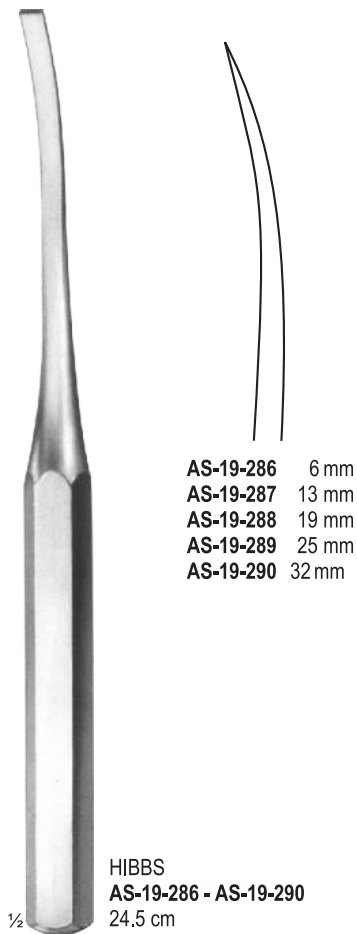
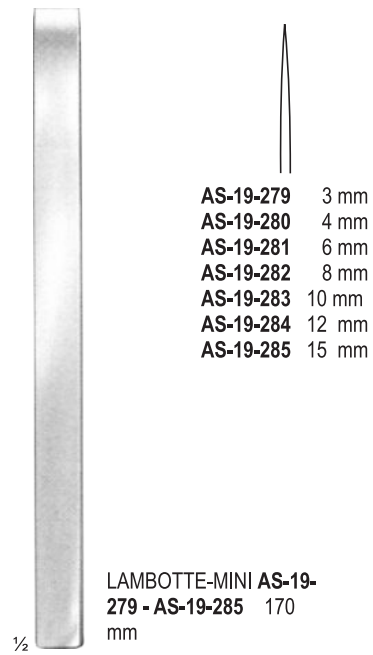
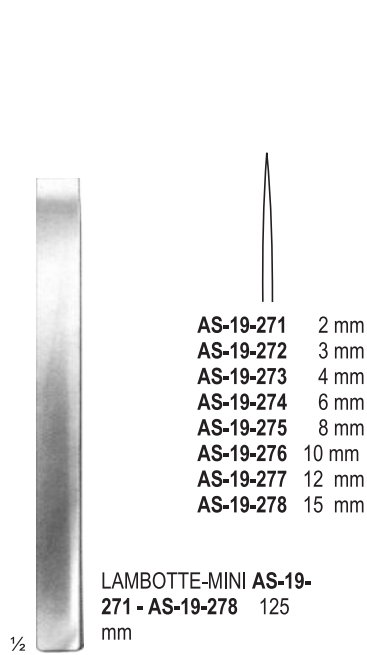

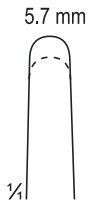

Haase
AS-19-301
100 mm



PASSOW
AS-19-302 - AS-19-303
120 mm



FREER
Chisel
AS-19-304
160 mm



FREER
Chisel, curved
AS-19-305
160 mm

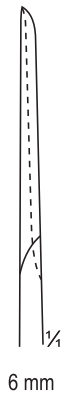

FREER
Gouge
AS-19-306
150 mm

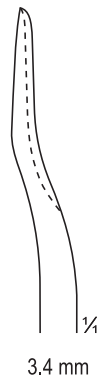

Scaphoid gouge,
downwards curved
AS-19-307
135 mm



Scaphoid gouge,
upwards curved
AS-19-308
135 mm



Mannerfelt
AS-19-309 - AS-19-311
AS-19-309 4 mm
AS-19-310 6 mm
AS-19-311 8 mm
155 mm

OSTEOTOMES CHISELS AND GOUGES

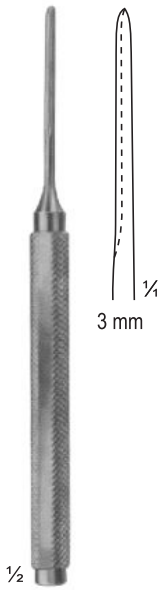

AS-19-312
Mannerfelt
155 mm

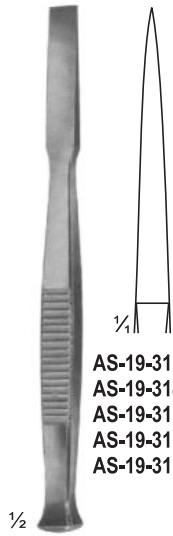

AS-19-313 - AS-19-317
Osteotome
140 mm

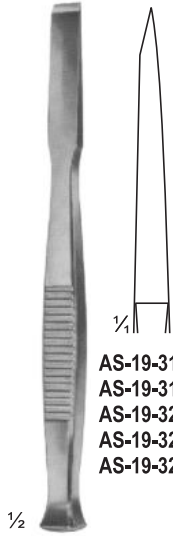

AS-19-318 - AS-19-322
Chisels
140 mm

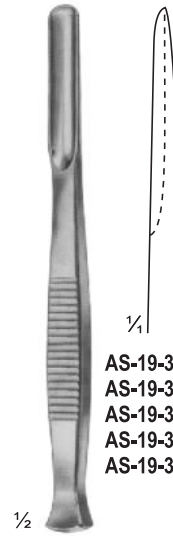

AS-19-323 - AS-19-327
Gouges
140 mm

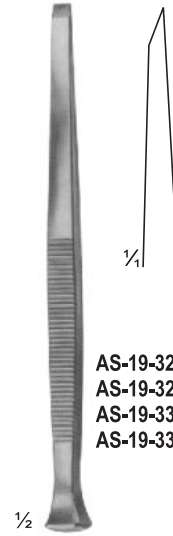

PARTSCH
AS-19-328 - AS-19-331
CHISELS
140 mm

- AS-19-313 4 mm
- AS-19-314 6 mm
- AS-19-315 8 mm
- AS-19-316 10 mm
- AS-19-317 12 mm

- AS-19-318 4 mm
- AS-19-319 6 mm
- AS-19-320 8 mm
- AS-19-321 10 mm
- AS-19-322 12 mm

- AS-19-323 4 mm
- AS-19-324 6 mm
- AS-19-325 8 mm
- AS-19-326 10 mm
- AS-19-327 12 mm

- AS-19-328 3 mm
- AS-19-329 4 mm
- AS-19-330 5 mm
- AS-19-331 6 mm

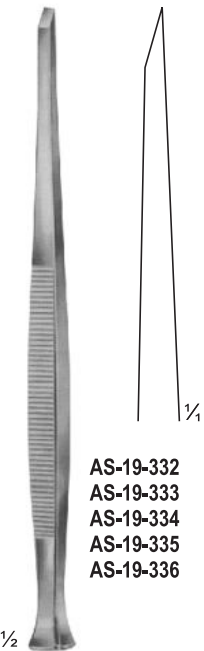

PARTSCH
AS-19-332 - AS-19-336
Chisels
170 mm
PARTSCH

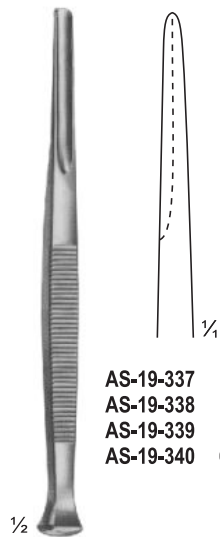

AS-19-337 - AS-19-340
Gouges
140 mm
PARTSCH

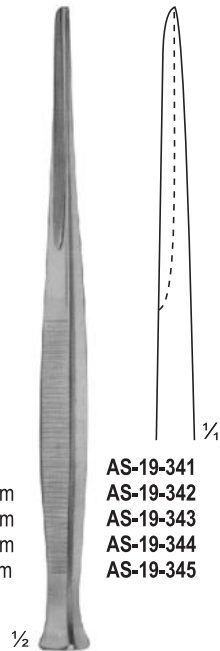

AS-19-341 - AS-19-345
Gouges
170 mm
LUCAS



AS-19-346 - AS-19-347
Chisels
160 mm
LUCAS

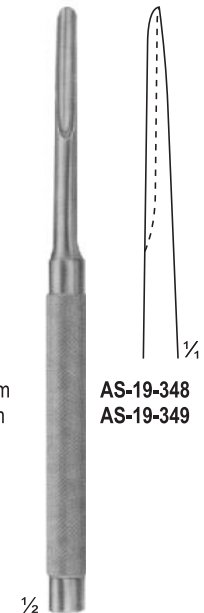

AS-19-348 - AS-19-349
Gouges
160 mm

- AS-19-332 3 mm
- AS-19-333 4 mm
- AS-19-334 5 mm
- AS-19-335 6 mm
- AS-19-336 7 mm

- AS-19-337 3 mm
- AS-19-338 4 mm
- AS-19-339 5 mm
- AS-19-340 6 mm

- AS-19-341 3 mm
- AS-19-342 4 mm
- AS-19-343 5 mm
- AS-19-344 6 mm
- AS-19-345 7 mm

- AS-19-346 4 mm
- AS-19-347 6 mm

- AS-19-348 3 mm
- AS-19-349 5 mm

OSTEOTOMES CHISELS AND GOUGES

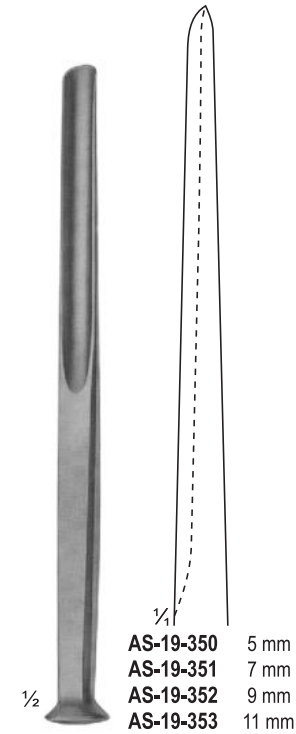

ALEXANDER
AS-19-350 - AS-19-353
 Gouges
 170 mm

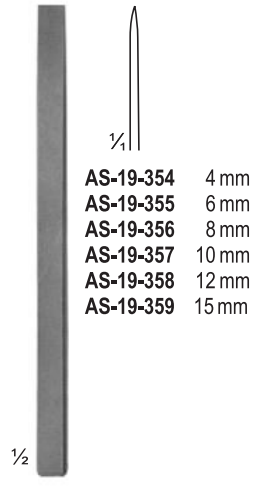

LAMBOTTE
AS-19-354 - AS-19-359
 Osteotome
 125 mm

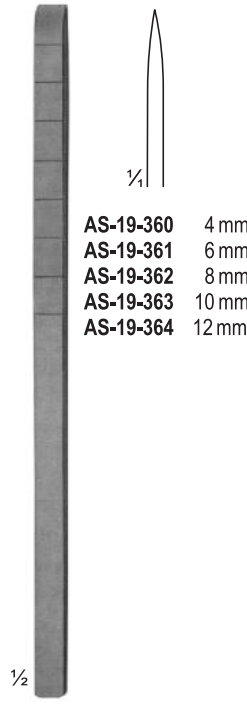

COTTLE
AS-19-360 - AS-19-364
 Osteotome with depth markings
 180 mm

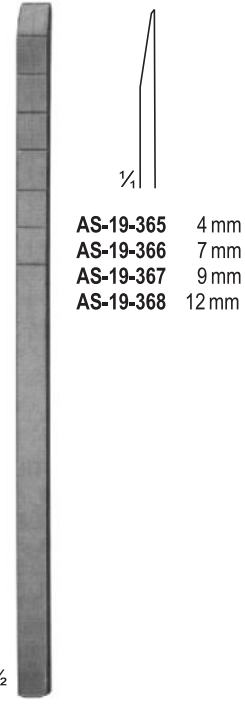

COTTLE
AS-19-365 - AS-19-368
 Chisel-Osteotomes with depth markings
 180 mm

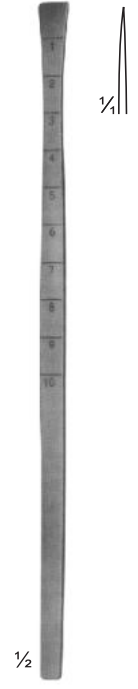

COTTLE
AS-19-369
 Fishtail Chisel, with protected ends
 180 mm

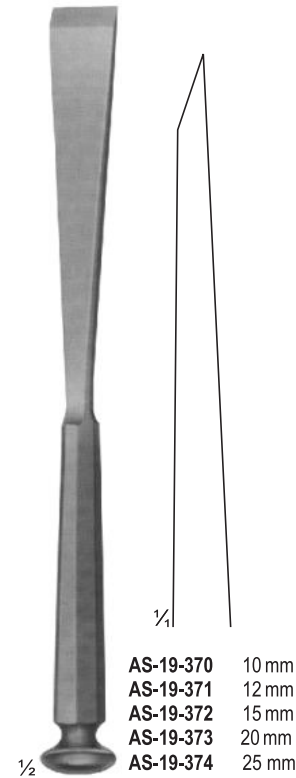

STILLE
AS-19-370 - AS-19-374
 Chisels
 205 mm

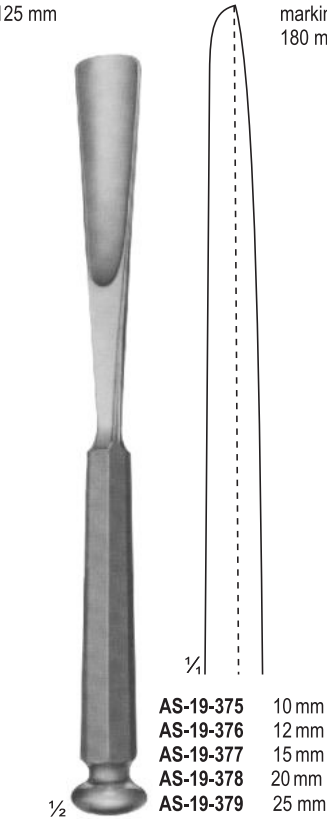

STILLE
AS-19-375 - AS-19-379
 Gouges
 205 mm

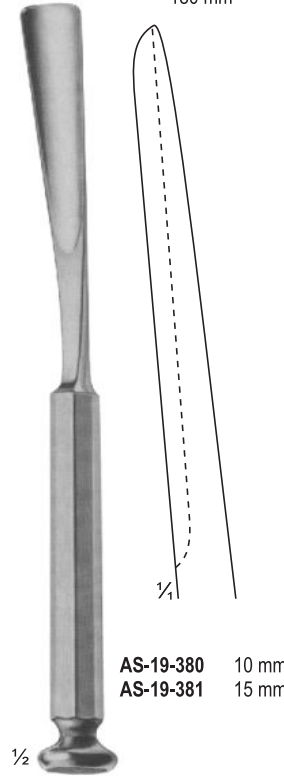

WALTER
AS-19-380 - AS-19-381
 Osteotomes gouges for taking grafts from the rib
 205 mm

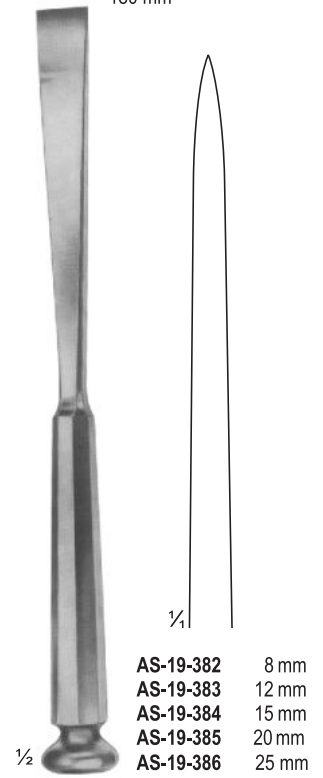

STILLE
AS-19-382 - AS-19-386
 Osteotomes
 205 mm



<p>1/2</p> <p>AS-19-387 10 mm AS-19-388 12 mm AS-19-389 15 mm AS-19-390 20 mm AS-19-391 25 mm</p> <p>1/4</p> <p>1/2</p> <p>STILLE AS-19-387 - AS-19-391 Osteotomes 205 mm</p>	<p>AS-19-392 10 mm AS-19-393 12 mm AS-19-394 15 mm AS-19-395 20 mm AS-19-396 25 mm</p> <p>1/4</p> <p>1/2</p> <p>STILLE AS-19-392 - AS-19-396 Osteotomes, curved 205 mm</p>	<p>AS-19-397 4 mm AS-19-398 8 mm AS-19-399 10 mm AS-19-400 13 mm AS-19-401 15 mm AS-19-402 18 mm AS-19-403 20 mm AS-19-404 25 mm AS-19-405 30 mm AS-19-406 38 mm AS-19-407 44 mm AS-19-408 50 mm</p> <p>1/4</p> <p>1/2</p> <p>LAMBOTTE AS-19-397 - AS-19-408 Osteotomes 245 mm</p>	<p>AS-19-409 8 mm AS-19-410 13 mm AS-19-411 18 mm AS-19-412 25 mm AS-19-413 30 mm AS-19-414 38 mm</p> <p>1/4</p> <p>1/2</p> <p>LAMBOTTE AS-19-409 - AS-19-414 Osteotomes, curved 245 mm</p>
--	---	---	--

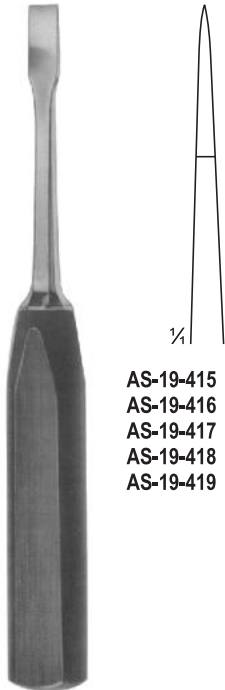

- AS-19-415 4 mm
- AS-19-416 6 mm
- AS-19-417 8 mm
- AS-19-418 10 mm
- AS-19-419 12 mm

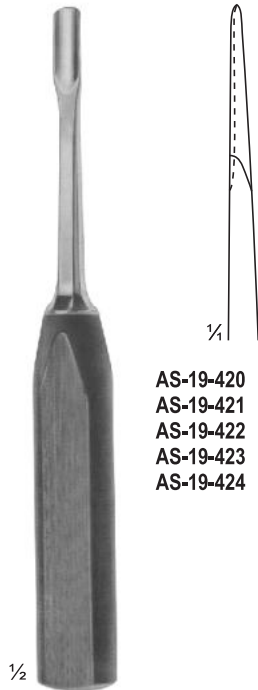

- AS-19-420 4 mm
- AS-19-421 6 mm
- AS-19-422 8 mm
- AS-19-423 10 mm
- AS-19-424 12 mm



- AS-19-425 5 mm
- AS-19-426 7 mm
- AS-19-427 10 mm
- AS-19-428 15 mm
- AS-19-439 20 mm
- AS-19-430 25 mm
- AS-19-431 30 mm

LEXER-MINI AS-19-415 - AS-19-419
Osteotomes
180 mm

LEXER-MINI AS-19-420 - AS-19-424
Gouges
180 mm

LEXER
AS-19-425 - AS-19-431
Osteotomes
220 mm



- AS-19-432 5 mm
- AS-19-433 7 mm
- AS-19-434 10 mm
- AS-19-435 15 mm
- AS-19-436 20 mm
- AS-19-437 25 mm
- AS-19-438 30 mm

LEXER
AS-19-432 - AS-19-438
Gouges
220 mm



LEXER
AS-19-439
Gouge for removing broken screws
220 mm



- AS-19-440 5,5 mm
- AS-19-441 9,0 mm

ZIELKE
AS-19-440 - AS-19-441
Gouge for scoliose-operations
230 mm

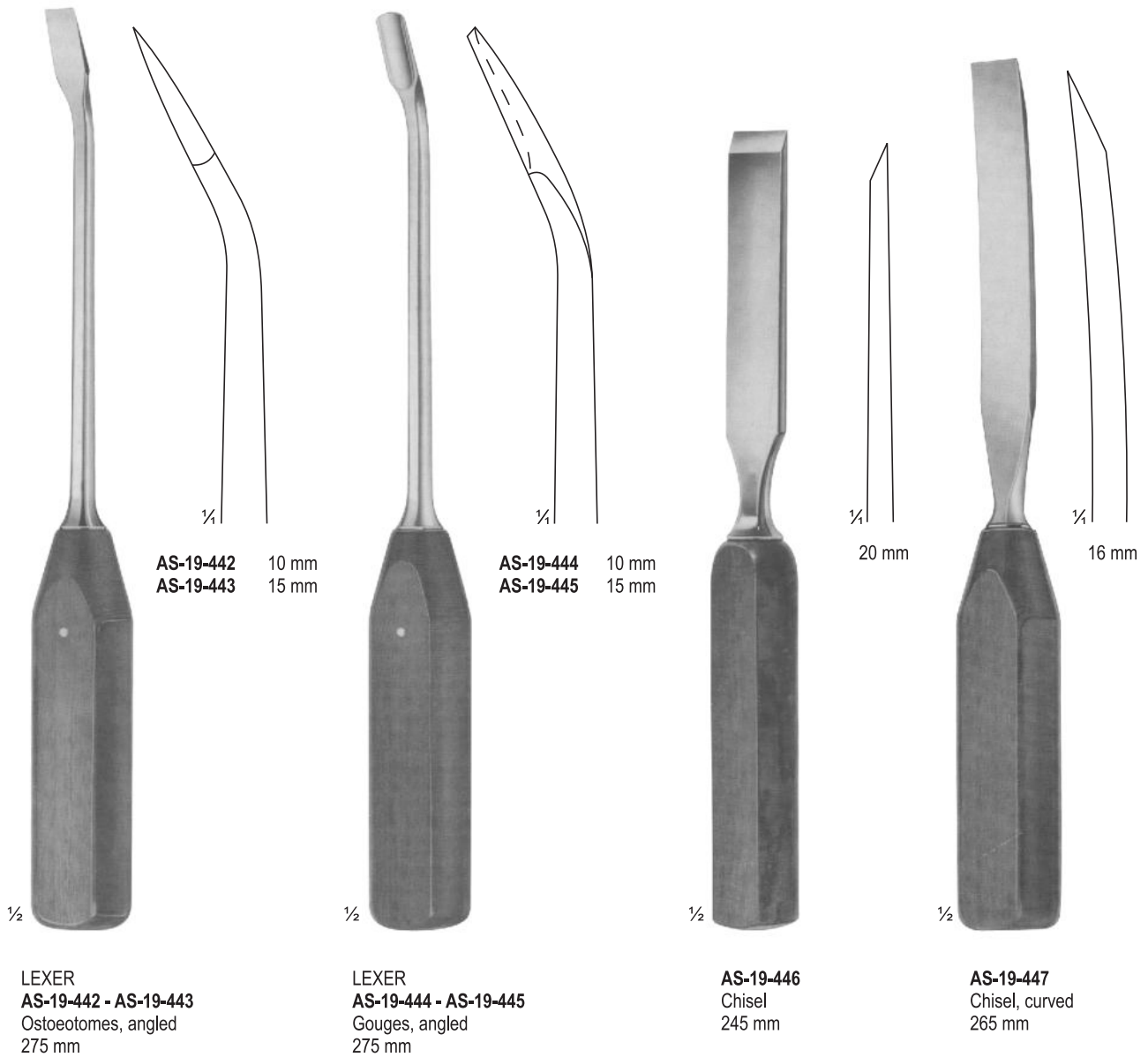

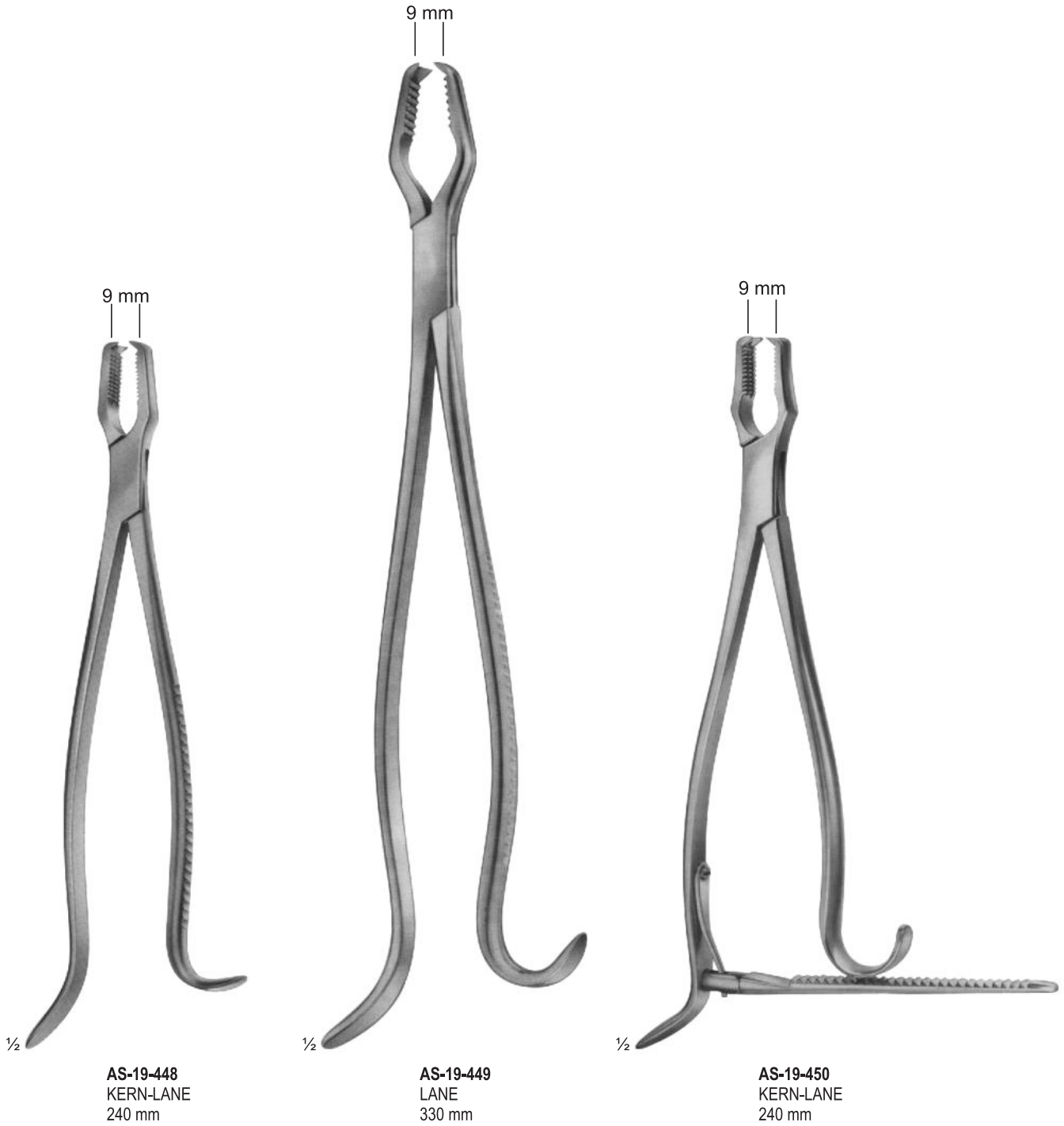



AS-19-451 - AS-19-455
AS-19-451 145 mm
AS-19-452 190 mm
AS-19-453 240 mm
AS-19-454 260 mm
AS-19-455 280 mm

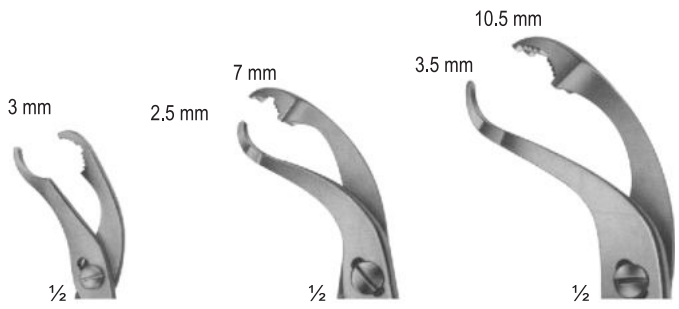

AS-19-451
 for small
 fragments

AS-19-452
 Fig: 0

AS-19-453
 Fig: 1

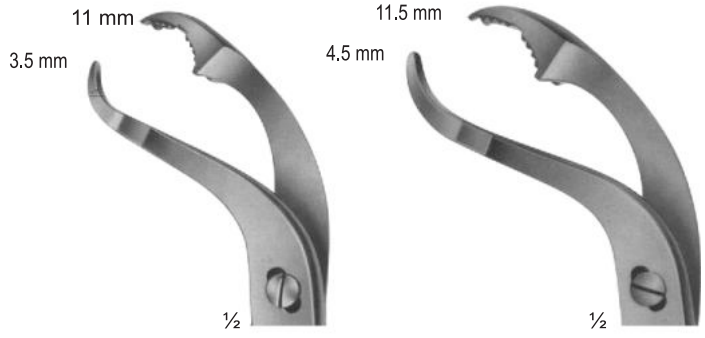

Self-centering forceps
 with thread fixation

AS-19-454
 Fig: 2

AS-19-455
 Fig: 3



AS-19-456 - AS-19-458
VERBRUGGE
 with lip joint

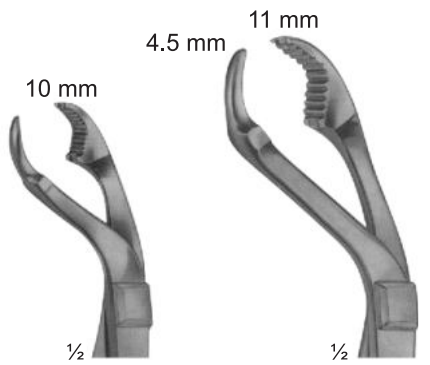

AS-19-456
 Fig: 1

AS-19-457
 Fig: 2



AS-19-458
 Fig: 3



AS-19-459
LAMBOTTE
 265 mm



AS-19-460 - AS-19-461
LOWMAN
AS-19-460 170 mm
AS-19-461 205 mm



AS-19-462
LOWMAN-GERSTER
210 mm



AS-19-463
LOWMAN-HOGLUND
175 mm



AS-19-464 AS-19-465

AS-19-464 - AS-19-465
Synovctomy rongeur
width of jaws 1.2 mm
130 mm

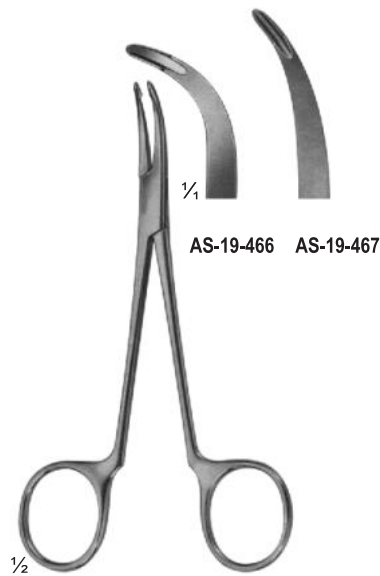

AS-19-466 AS-19-467

AS-19-466 - AS-19-467
Synovctomy rongeur
width of jaws 2.0 mm
130 mm

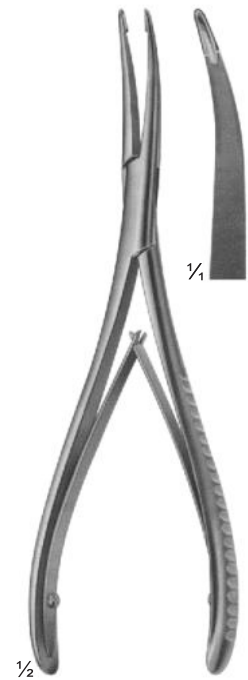

AS-19-468
STELLBRINK
Synovctomy
rongeur 175 mm

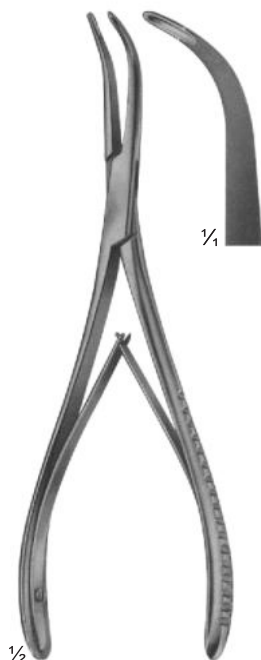

AS-19-469
STELLBRINK
Synovctomy
rongeur 170 mm

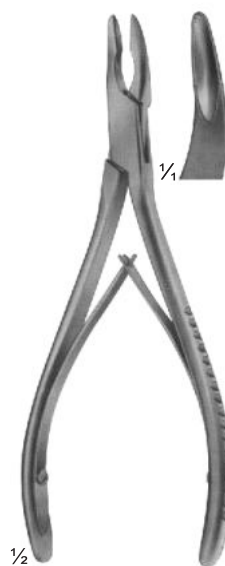

**AS-19-470 LURE-
FRIEDMANN** 145
mm

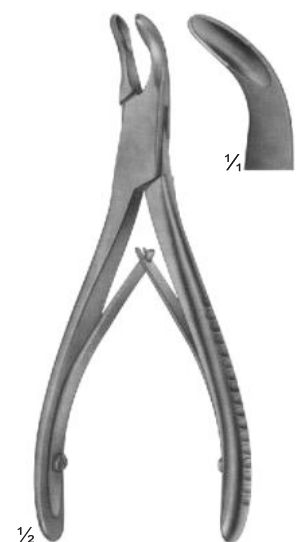

AS-19-471
140 mm



AS-19-472
LURE
150 mm

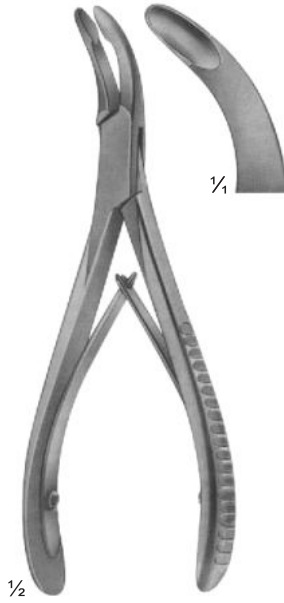

AS-19-473
LURE
155 mm

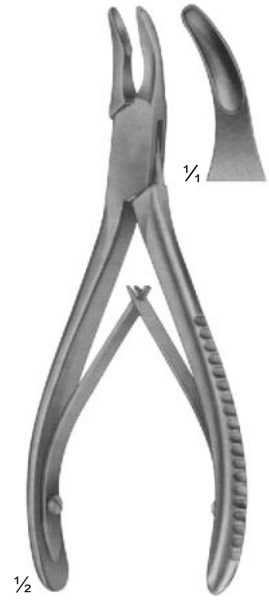

AS-19-474
BLUMENTHAL
155 mm

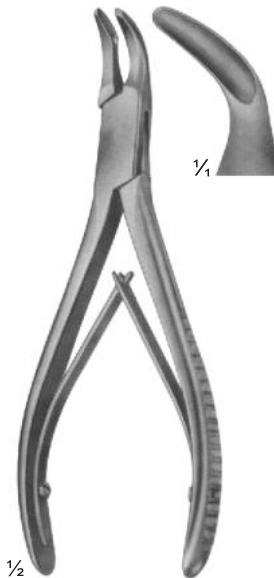

AS-19-475
BLUMENTHAL
150 mm

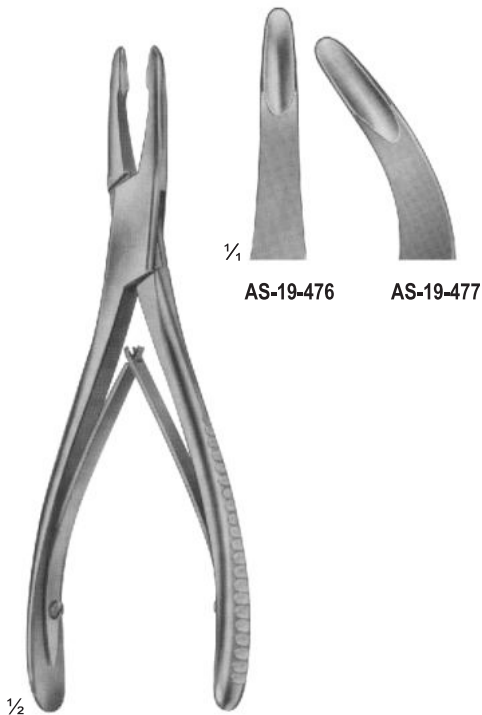

AS-19-476 - AS-19-477
JANSSEN
175 mm

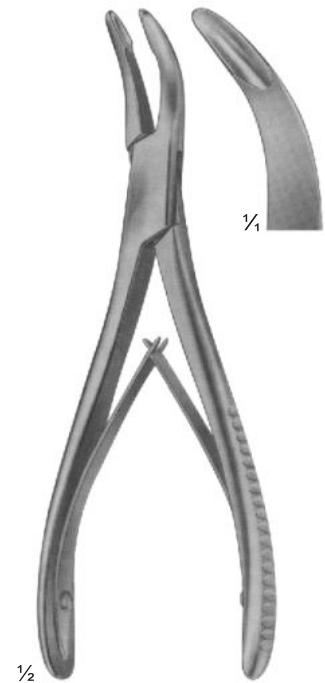

**AS-19-478 BANE-
HARTMANN** 175
mm

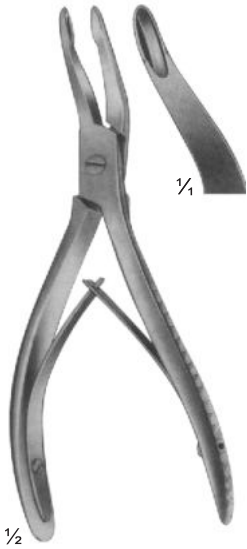

AS-19-479
ALEXANDER
140 mm

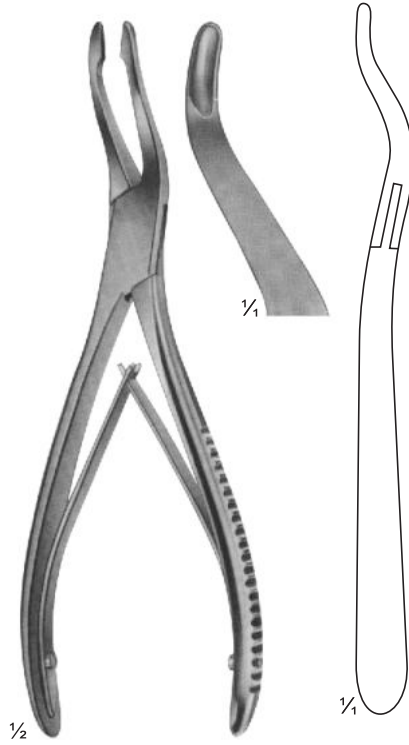

AS-19-480
JANSEN
190 mm

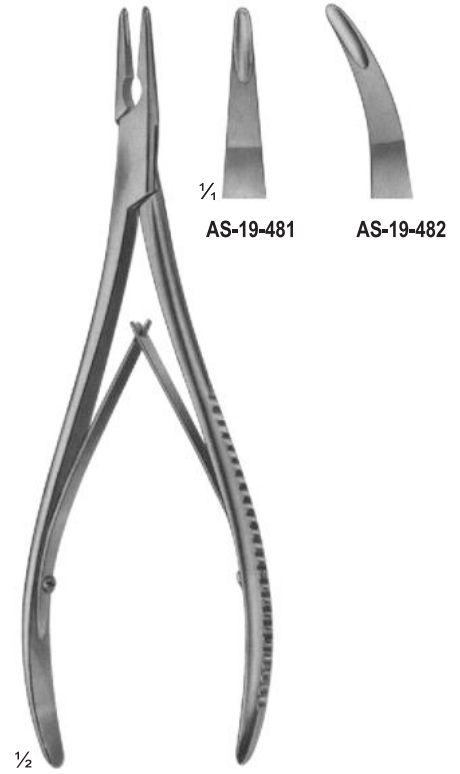

AS-19-481 - AS-19-482
LEMPERT
200 mm

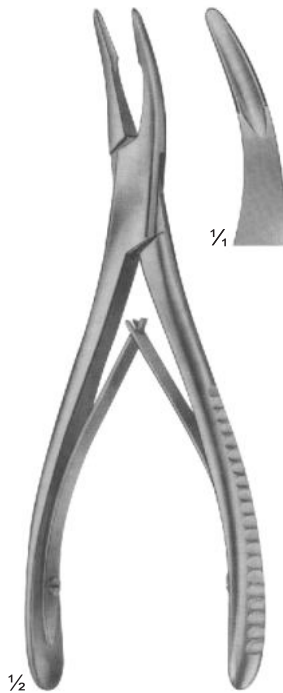

AS-19-483
BEYER
180 mm

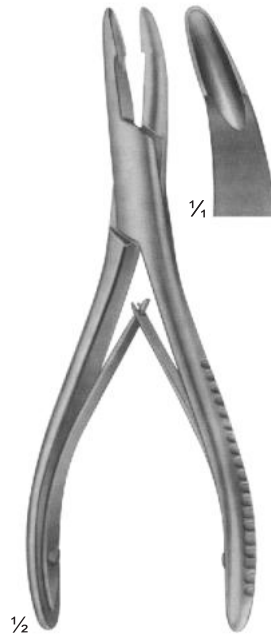

AS-19-484
MEAD
165 mm

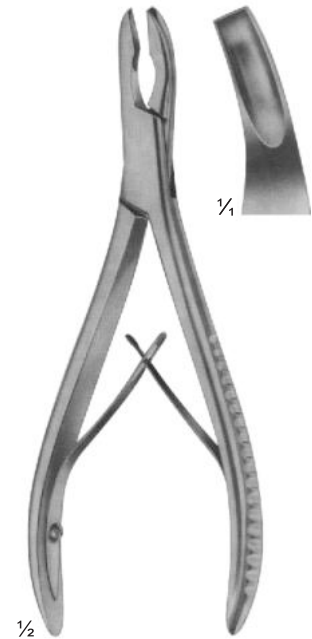

AS-19-485
MEAD
165 mm

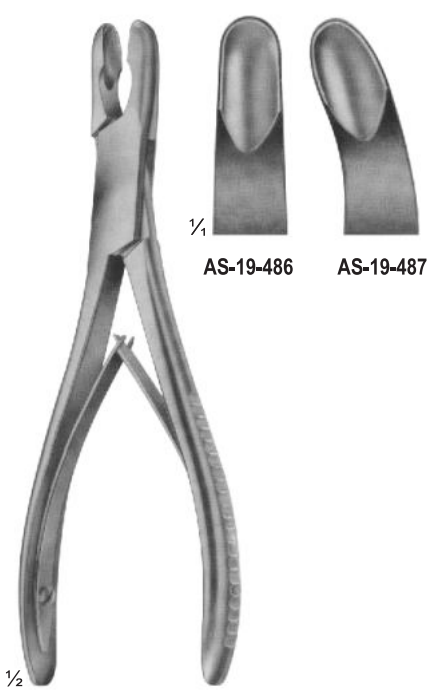

¼ AS-19-486 AS-19-487

AS-19-486 - AS-19-487
LURE
175 mm

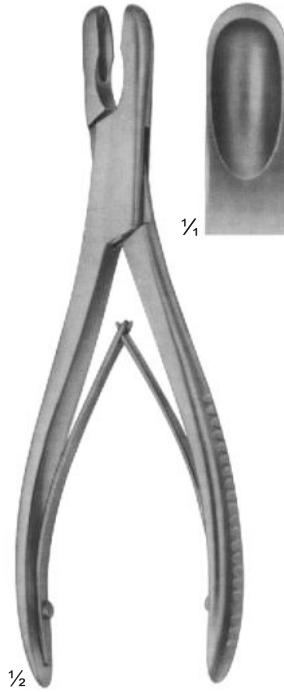

¼

AS-19-488
LURE
180 mm

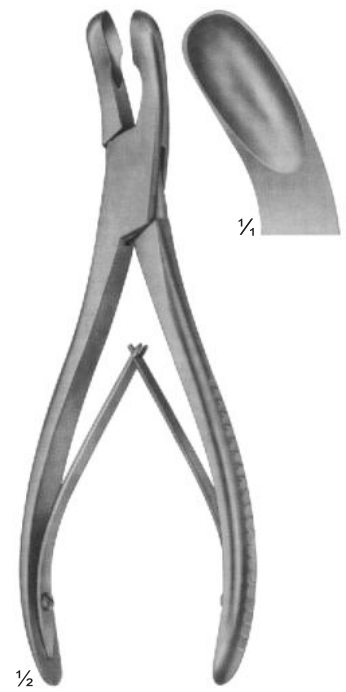

¼

AS-19-499
LURE
180 mm

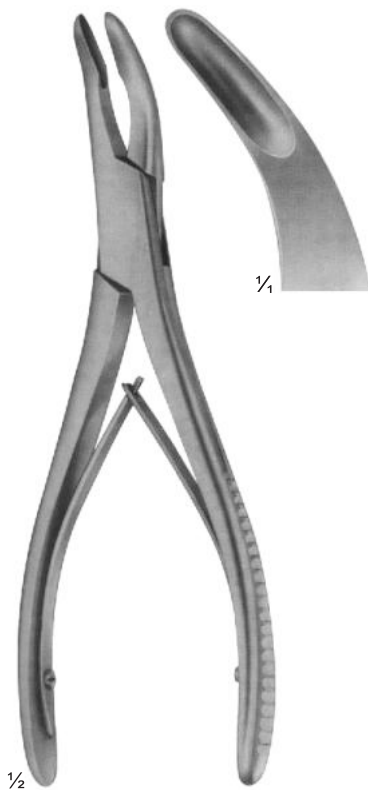

¼

AS-19-490
OLIVECRONA
205 mm



¼ AS-19-491 AS-19-492

AS-19-491 - AS-19-492
BOHLER
155 mm

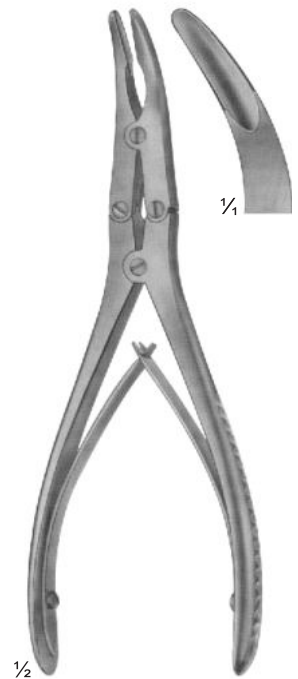

¼

AS-19-493
MARQUARDT
200 mm

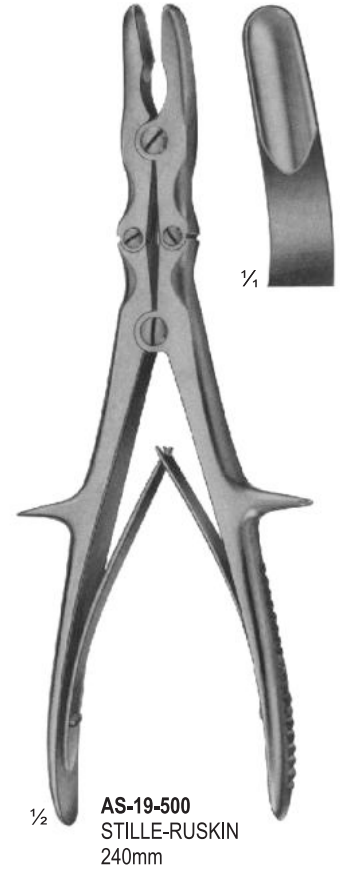
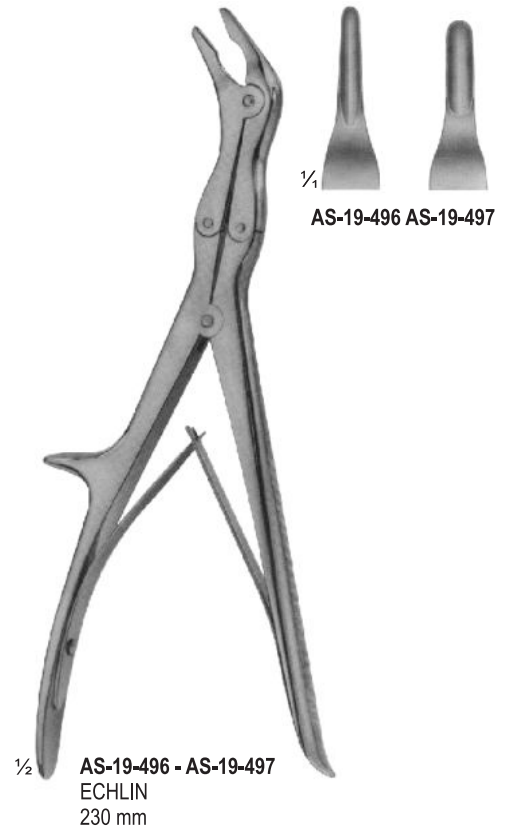
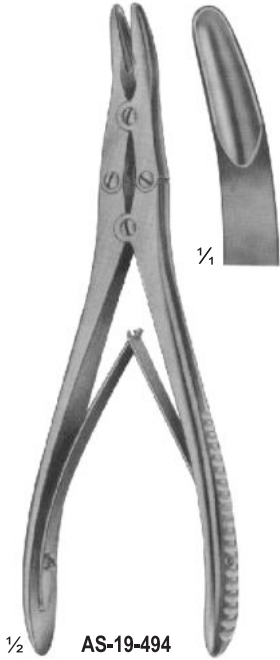

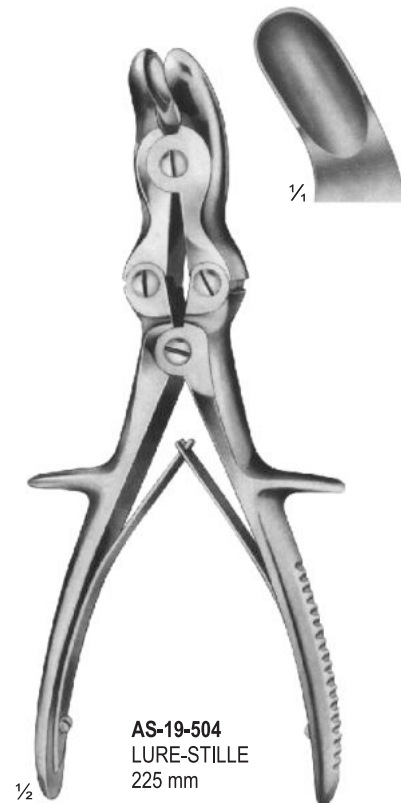
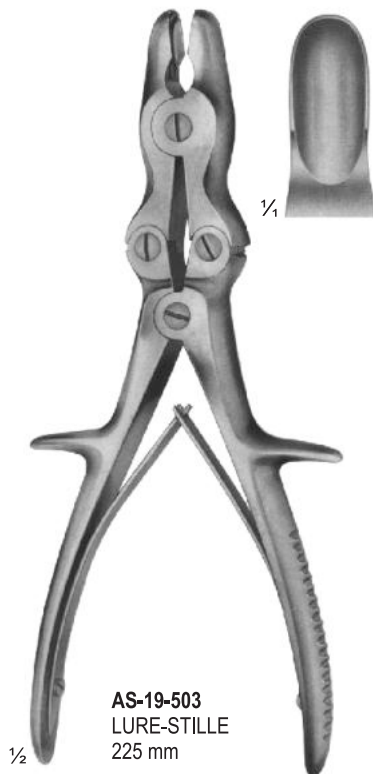
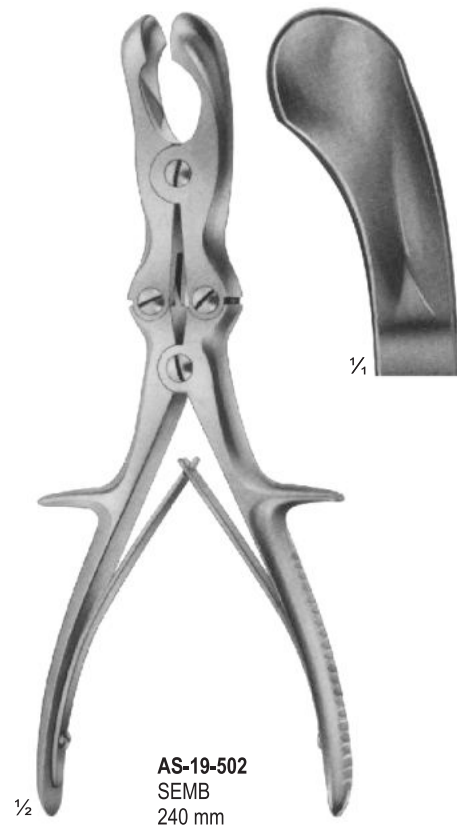
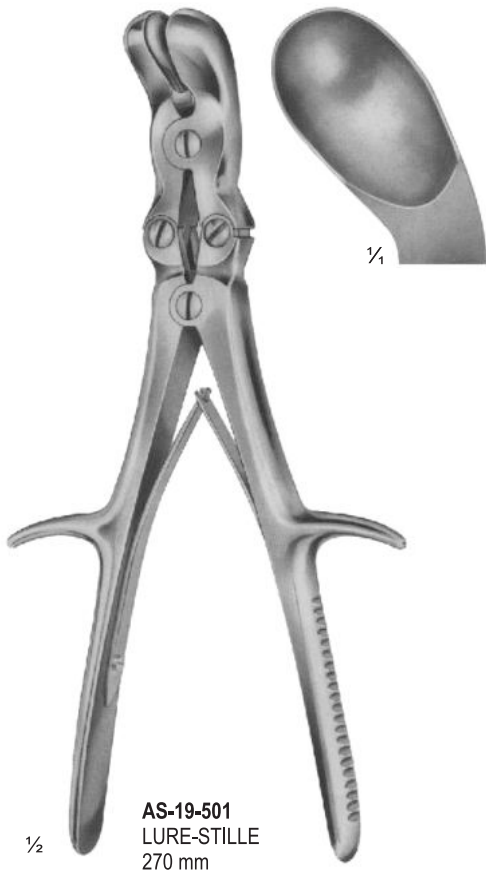

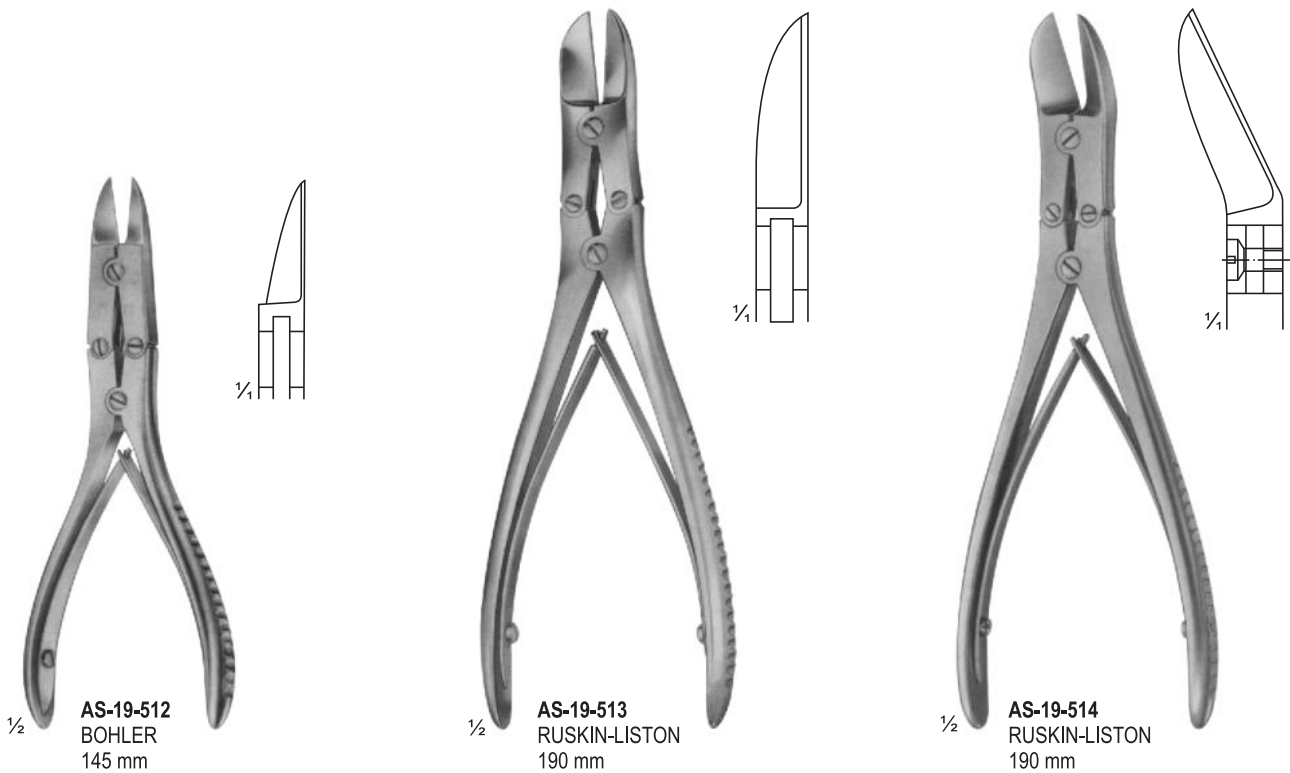
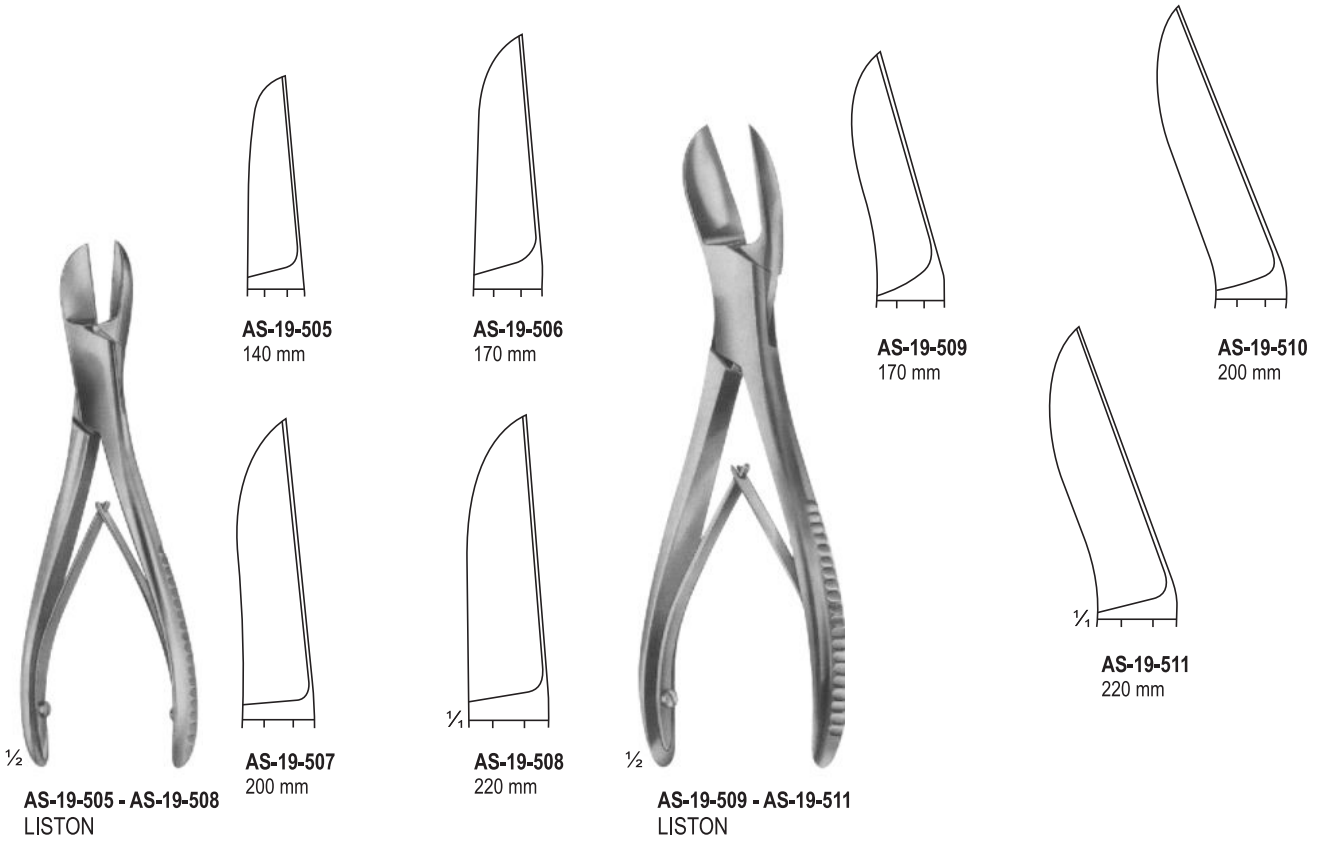

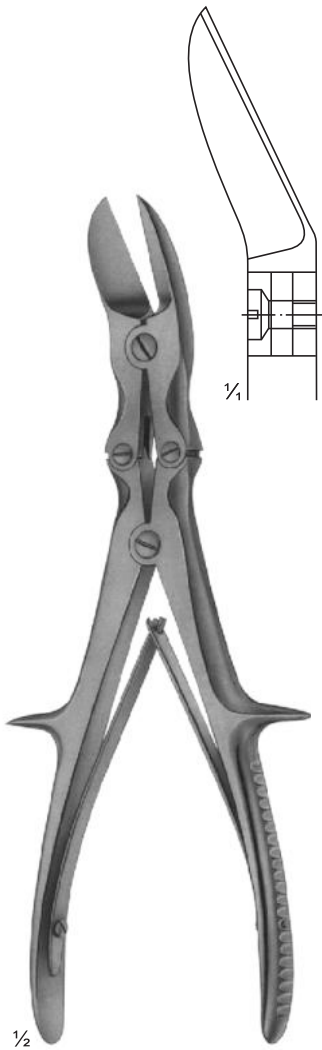

AS-19-515
LISTON
curved on
flat 240 mm

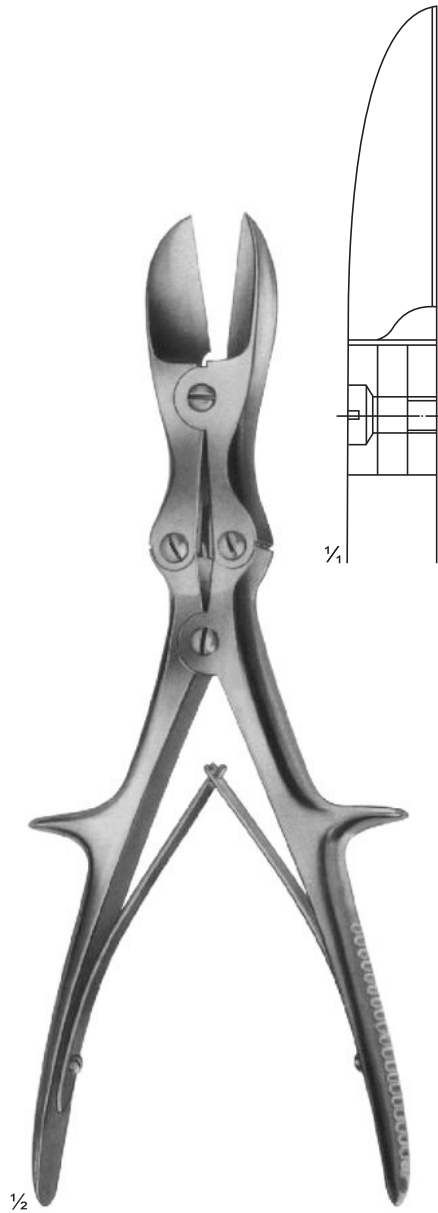

AS-19-516
LISTON
straight
280 mm

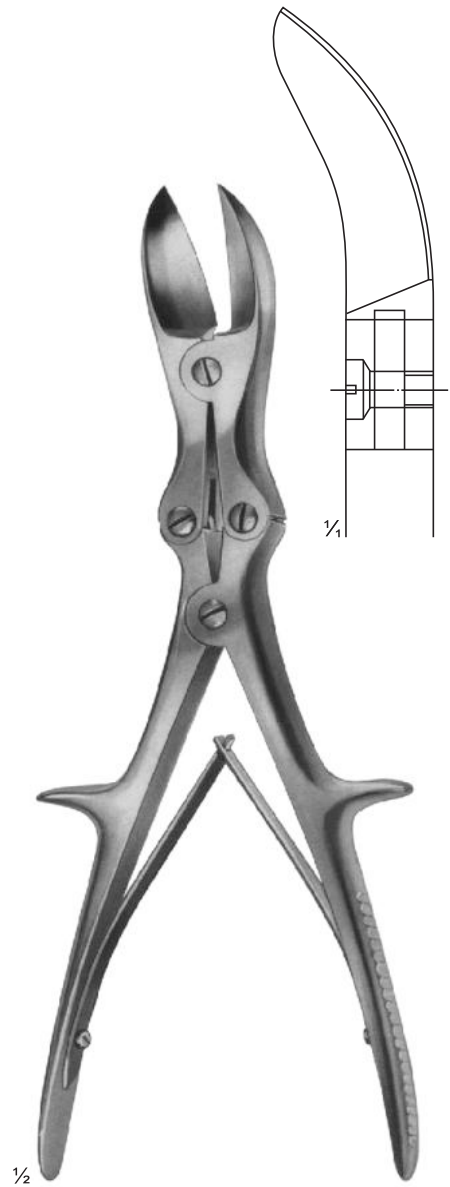

AS-19-517
LISTON
curved on
flat 280 mm

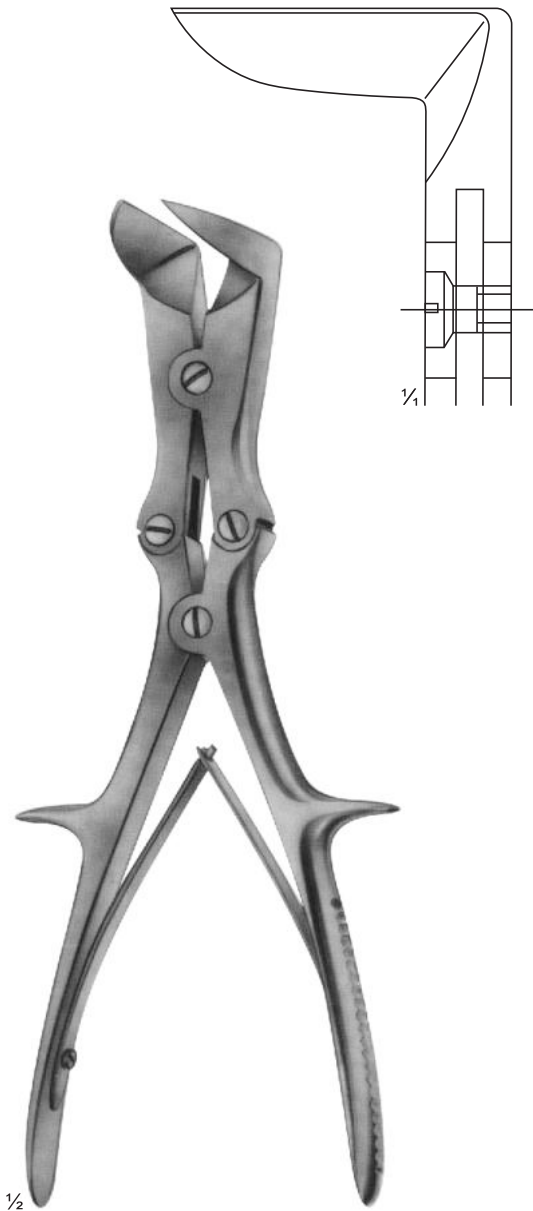

AS-19-518
LISTON-STILLE
265 mm

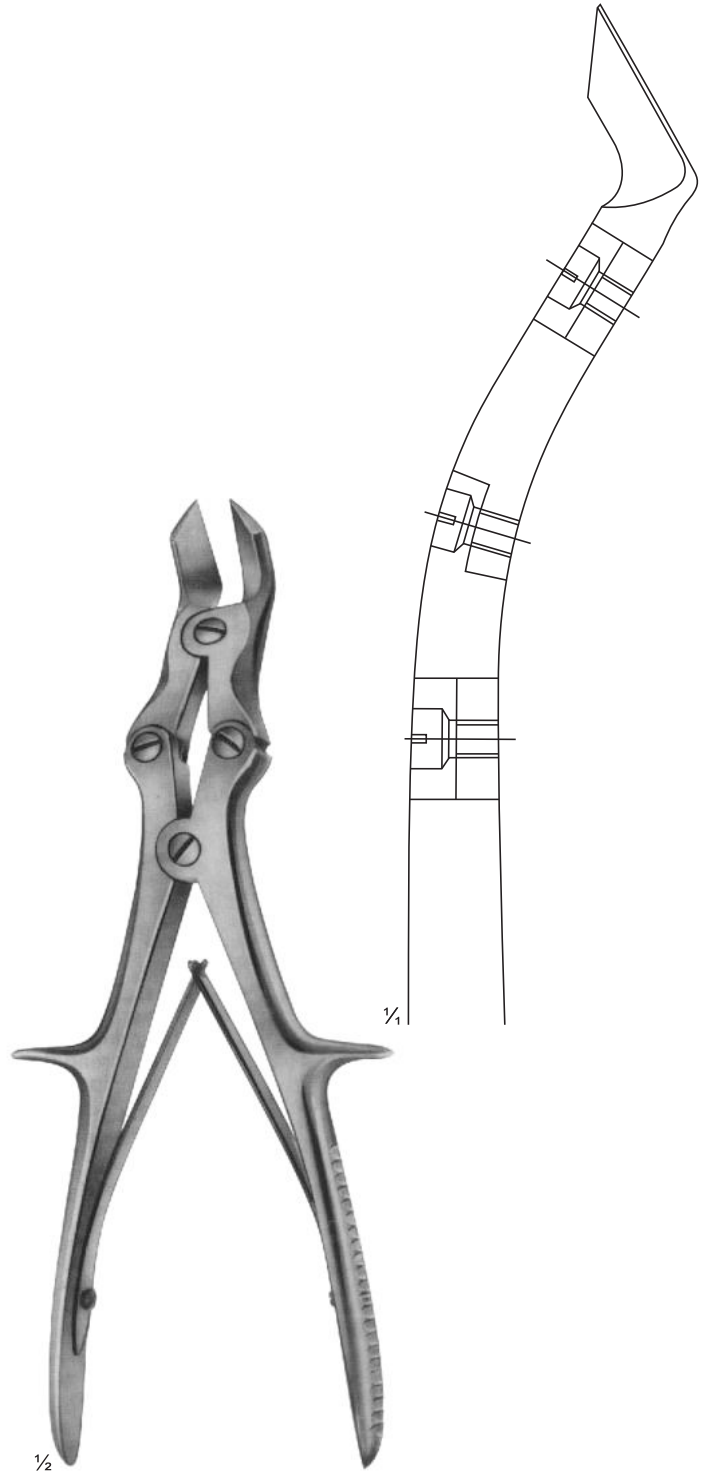

AS-19-519 LISTON-
KEY-HORSLEY
(TUDOR EDWARDS)
255 mm

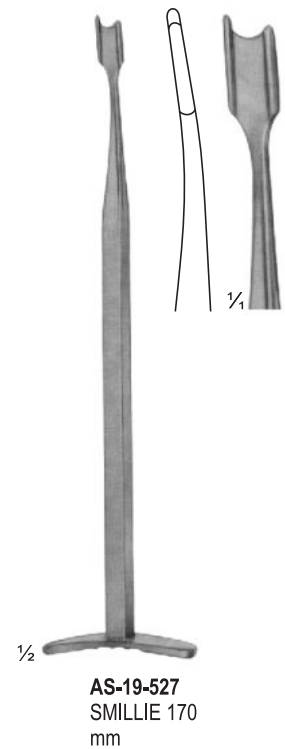
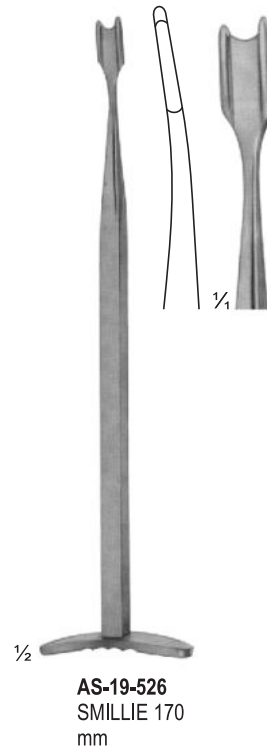
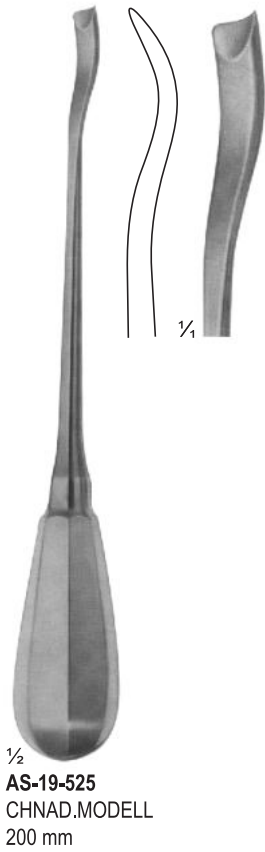
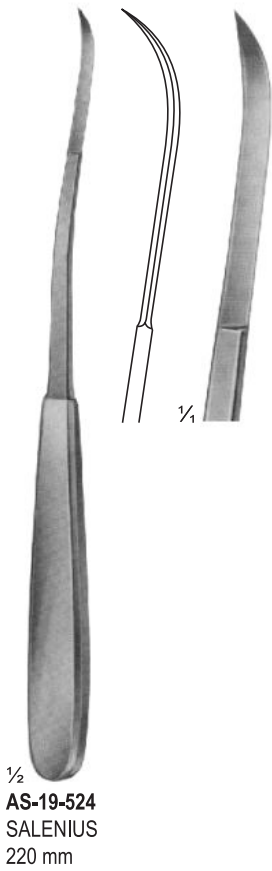
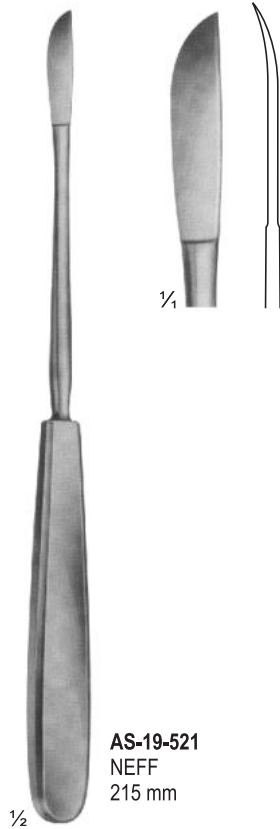
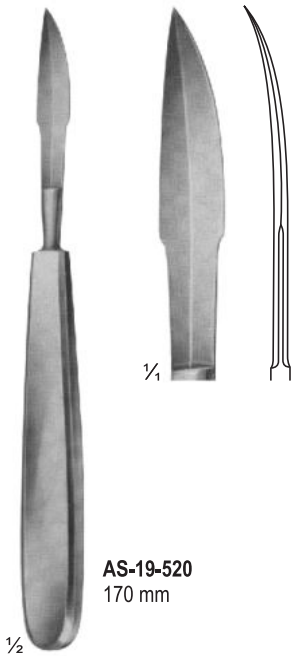

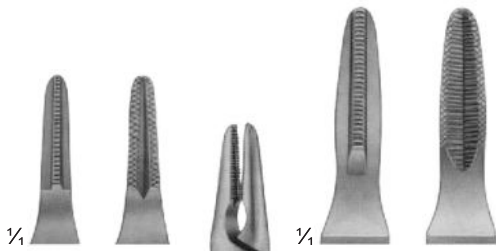

AS-19-528
130 mm

AS-19-529
180 mm



Extraction pliers for boring wires
AS-19-528 - AS-19-529



Flat-nosed pliers, parallel
AS-19-530
185 mm

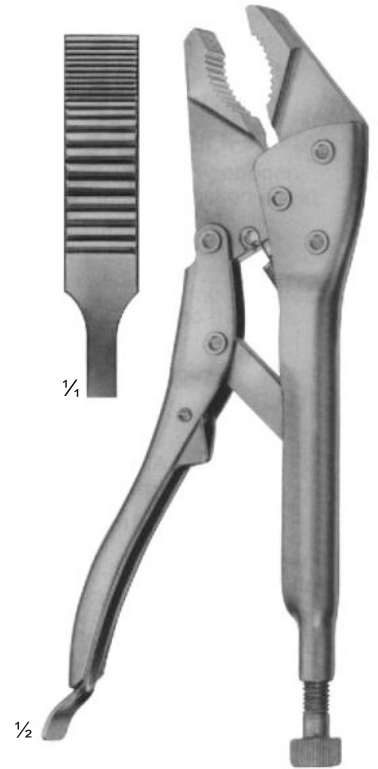
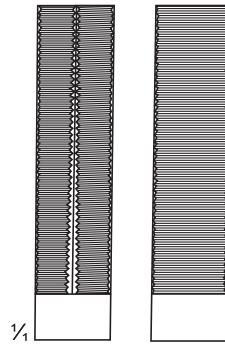

Vise grip
AS-19-531
200 mm

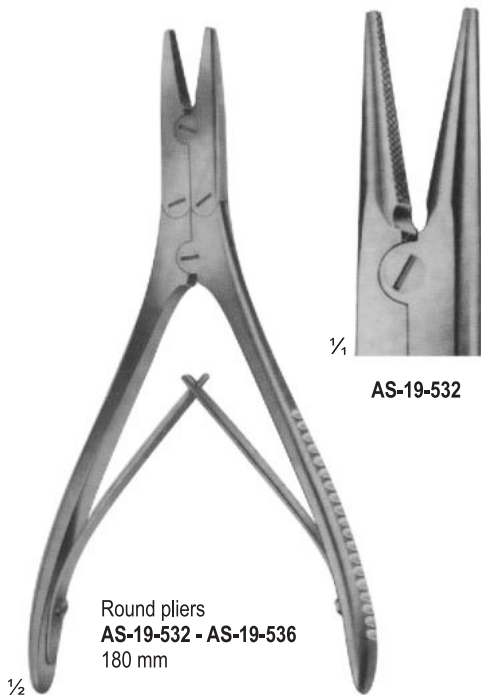

Round pliers
AS-19-532 - AS-19-536
180 mm

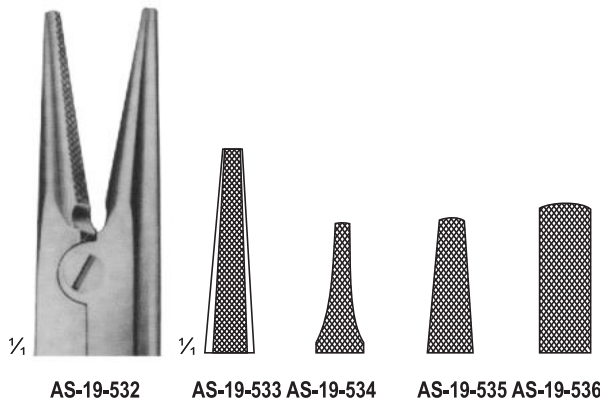

AS-19-533
AS-19-534 14,5 cm
AS-19-535 18 cm
AS-19-536 18 cm
Extraction pliers for
wires

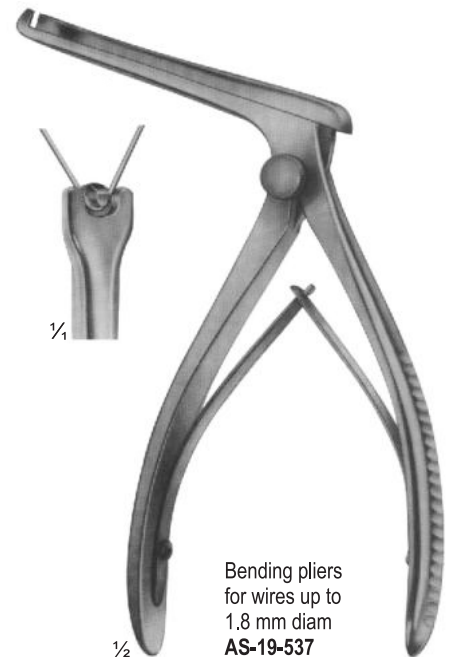

Bending pliers
for wires up to
1.8 mm diam
AS-19-537



BOHLER
AS-19-538
145 mm

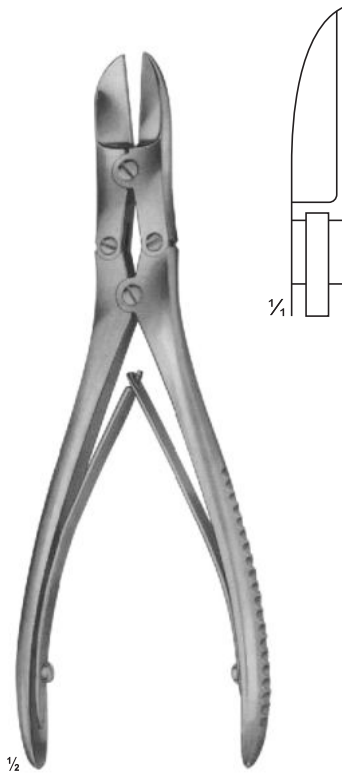

RUSKIN-LISTON
AS-19-539
190 mm

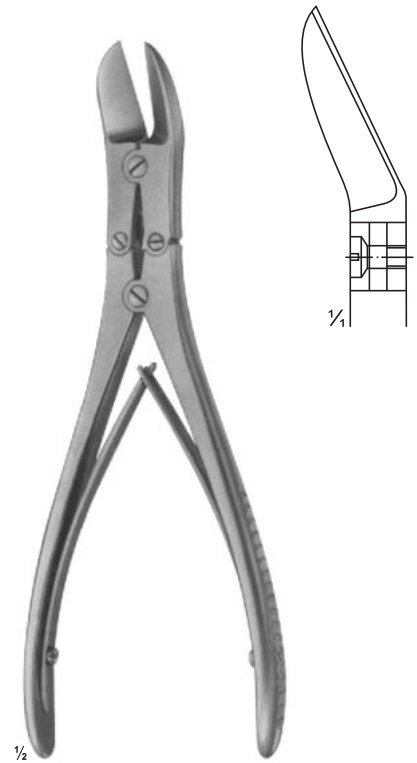

RUSKIN-LISTON
AS-19-540
190 mm

WIRE CUTTING PLIERS, LATERAL CUTTING ACTION



AS-19-541
180 mm

for soft wire
up to diam. 2,0 mm
For hard wire 1,5 mm
up to diam
specially hardened
cutting edges, front
and lateral cutting
action

REILL AS-19-542
175 mm

for soft wire
up to diam. 2,0 mm
For hard wire 1,6 mm
up to diam
specially hardened
cutting edges, for
cutting off wires close
to the bone

AS-19-543
235 mm

for soft wire
up to diam. 3,0 mm
For hard wire 2,2 mm
up to diam

WIRE CUTTING PLIERS, LATERAL AND FRONT CUTTING ACTION



AS-19-544
240 mm

for soft wire up to diam. 2 mm
For hard wire up to diam 1.6 mm

AS-19-545
140 mm

for soft wire up to diam. 1.5 mm
For hard wire up to diam 1 mm

AS-19-546
145 mm

for soft wire up to diam. 2 mm
For hard wire 1.5 mm

AS-19-547
220 mm

for soft wire up to diam. 3.5 mm
For hard wire 2.5 mm



AS-19-548
320 mm

for soft wire up to diam. 3 mm
For hard wire up to diam 3 mm

Cutter for cutting off KIRSCHNER wires, Tibia head screws, bolts, pins, up to 3 mm diam.



AS-19-549
Cutter for cutting off KIRSCHNER wires, Tibia head screws, bolts, pins, up to 6 mm diam.
470 mm

Durotip

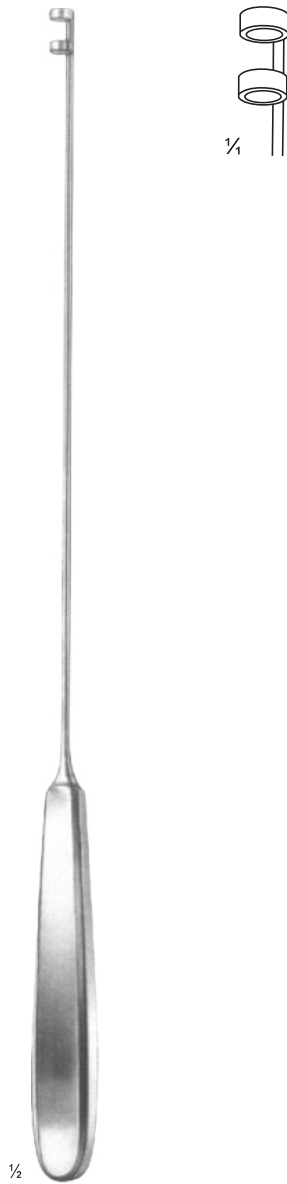

FISCHER
AS-19-550
310 mm
Blunt



AS-19-551
285 mm

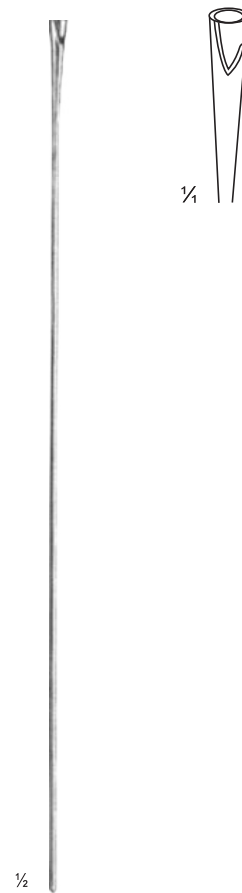

BUNNELL
AS-19-552
230 mm Tendon
Passer

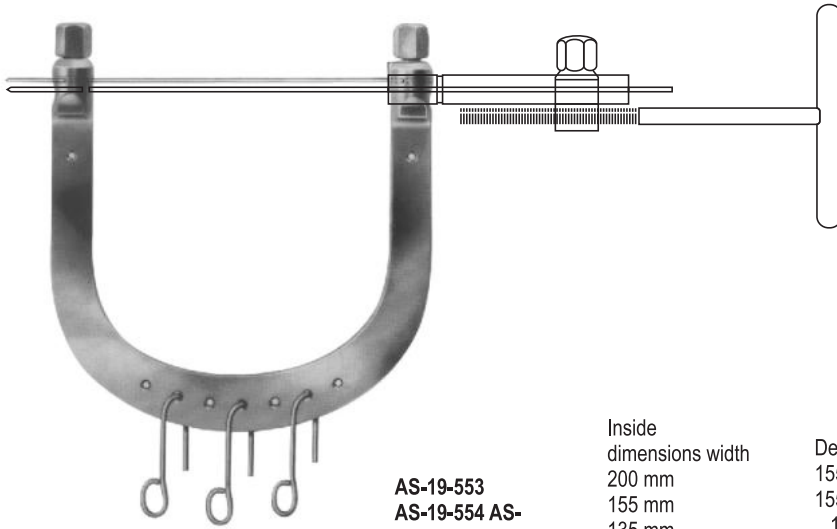

KIRSCHNER AS-19-553 - AS-19-559 Wire traction bows, to be used with KIRSCHNER-wires up to 2.5 mm diam., With 3 hooks, stainless steel

AS-19-553
AS-19-554 AS-
19-555 AS-19-
556 AS-19-557
AS-19-558 AS-
19-559

Inside dimensions width
 200 mm
 155 mm
 135 mm
 120 mm
 105 mm
 95 mm
 95 mm

Depth
 155 mm
 155 mm
 130 mm
 120 mm
 100 mm
 110 mm
 70 mm



AS-19-560
 Wrench, double - ended, for wire traction bows



AS-19-561
 Wire tightener, with clamping jaws



1/3

AS-19-562
 Traction hook only, large size



1/3

AS-19-563
 Traction hook only, small size



1/3

AS-19-564
 Fixation clamp, to secure clamping jaws of stainless steel

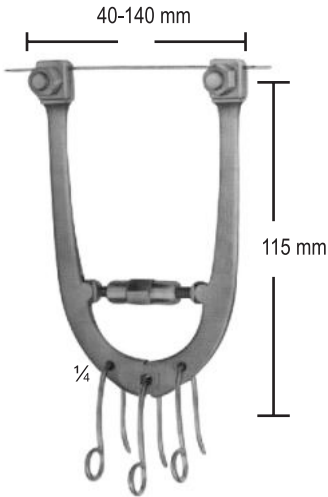

AS-19-565
Wire traction bow, adjustable, with 3 hooks, small size

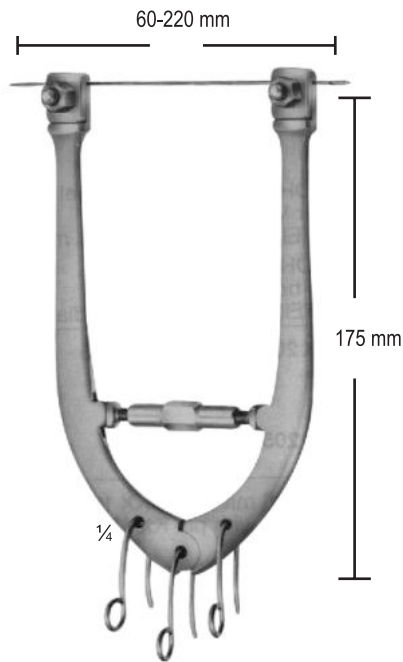

AS-19-566
Wire traction bow, adjustable, with 3 hooks, large size

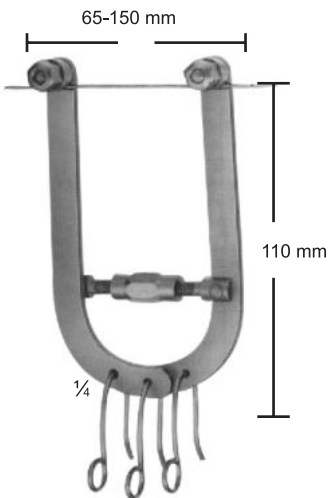

AS-19-567
Wire traction bow, adjustable, with 3 hooks, large size for elbow and calcaneus, for adolescents



AS-19-570 10 cm
AS-19-571 16 cm
AS-19-572 20 cm

AS-19-573 1.6 mm
AS-19-574 2 mm
AS-19-575 2.5 mm

KIRSCHNER AS-19-570 - AS-19-575
Wire traction bow, modified adjustable in with width, holds wire securely, with 1 hook



AS-19-568
Fixation disc, slotted



AS-19-569
idem, aluminum, transparent to X-rays



AS-19-576
Fixation disc, slotted



AS-19-577
Screw driver, for above fixations discs



Steinmann pins, 4 mm daim.	Steinmann pins, 5 mm daim.
AS-19-578 with pin	16x9cm Arm
AS-19-579 without pin	AS-19-580-00 without
AS-19-581 with pin	21x11cm Arm
AS-19-582 without pin	AS-19-583 without
AS-19-584 with pin	21x15cm Arm
AS-19-585 without pin	

AS-19-578 - AS-19-585
Screw driver, for above fixations discs



AS-19-586 SCHWARZ
Traction bow for fingers, to be used with KIRSCHNER-wire up to 1.6 mm diam.

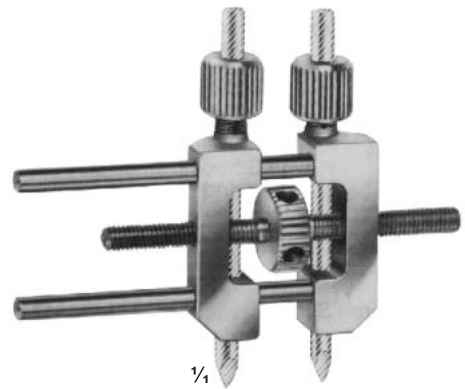

AS-19-587
Small distractor as a repositioning device for distraction and compression of small bones, for wires with 3 mm diam.



STEINMANN **AS-19-588 - AS-500**
triangular shaft ended
and trocar point

Length	4 mm	5 mm
80 mm	AS-19-588	
100 mm	AS-19-589	
120 mm	AS-19-590	
140 mm	AS-19-591	
150 mm	AS-19-592	AS-19-593
160 mm	AS-19-594	
180 mm	AS-19-595	AS-19-596
200 mm	AS-19-597	AS-19-598
210 mm	AS-19-599	
250 mm	AS-19-600	AS-19-601
300 mm		AS-19-602



$\frac{1}{4}$
AS-19-603
Protection cap
for 4 mm STEINMANN Pins



$\frac{1}{4}$
AS-19-604
Protection cap
for 5 mm STEINMANN Pins



REILL AS-19-605
Drilling chuck, cannulated, for shanks from 2.0 - 2.5 mm diam 115 mm



AS-19-606
Drilling chuck, cannulated, for shanks from 0.8 - 2.0 mm diam 150 mm



AS-19-607
Drilling chuck, cannulated, for shanks up to 4.5 mm diam with key 140 mm



LOUTE AS-19-608
Wire tightener, improved pattern, with movable tip, for wires up to 1.0 mm diam. 220 mm



AS-19-609
Drilling chuck, cannulated, for shanks up to 6.35 mm diam., To be tightened by hand 100 mm



AS-19-610
Drilling chuck, cannulated, for shanks up to 4.5 mm diam., And for triangular shaft width across flats 4.7 mm



AS-19-611
Drilling chuck, cannulated, for shanks up to 6.35 mm diam., With key 160 mm



AS-19-612
Nail extracting
forceps
135 mm

AS-19-613
Nail extracting
forceps
145 mm

MARTIN-IDEAL
AS-19-614 - AS-19-616
Finger nail drill
with 3 points

AS-19-614 AS-19-615 AS-19-616
Drill points only

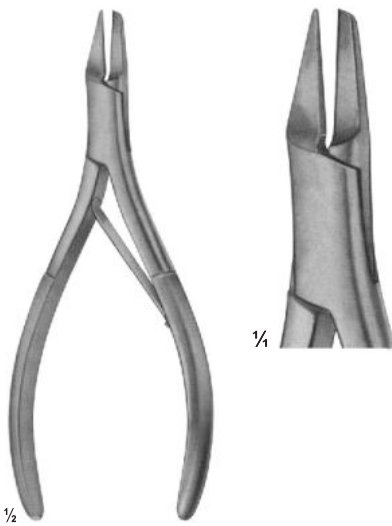

AS-19-617
Nail splitting
forceps
135 mm

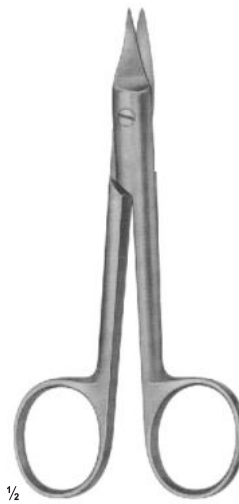

SYSTRUNK
AS-19-618
Scissors, for
splitting finger nails
130 mm

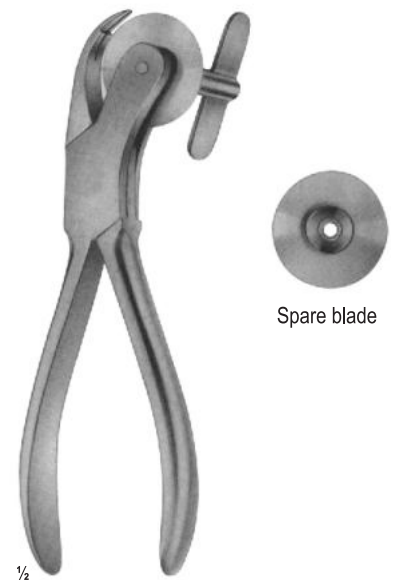

AS-19-619
Finger ring
saw 150 mm

Spare blade

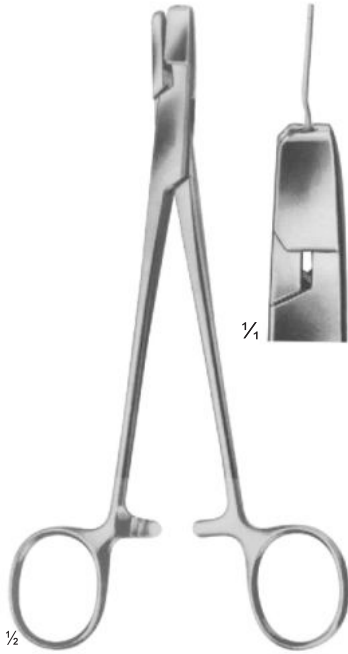

DUROGRIP AS-19-620
Holding forceps for cerclage
wire, with lateral jaws to avoid
wire slipping off
170 mm



DUROGRIP AS-19-621
Wire, tightening
pliers, Ligature pliers
150 mm



DUROGRIP AS-19-622
Wire, tightening
pliers, Ligature pliers
150 mm



AS-19-623
with serrated
jaws 140 mm

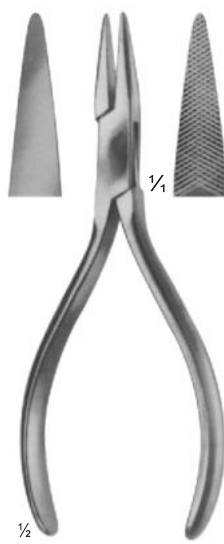

AS-19-624
one jaws smooth,
one jaws
serrated 140 mm



AS-19-625
with serrated jaws
AS-19-626
with longitudinal and
transversal grooves
170 mm



AS-19-627
190 mm



Durotip

AS-19-628
Cutter for cutting off
KIRSCHNER wires,
Tibia head screws,
bolts, pins, up to 6 mm
diam.
47 cm



AS-19-629
For Soft Wire \varnothing cm 3.5
For Hars Wire \varnothing cm
2.5 22 cm



AS-19-630
For Soft Wire \varnothing cm 2.0
For Hars Wire \varnothing cm
1.5 22 cm



AS-19-631
For Soft Wire \varnothing cm 2.0
For Hars Wire \varnothing cm
1.6 18 cm



AS-19-632
17 cm



ASAMAR
SURGICAL 

PAGE
464-470
PLASTER INSTRUMENTS

WIRE CUTTERS & WIRE CUTTING SCISSORS



ASAMAR
SURGICAL

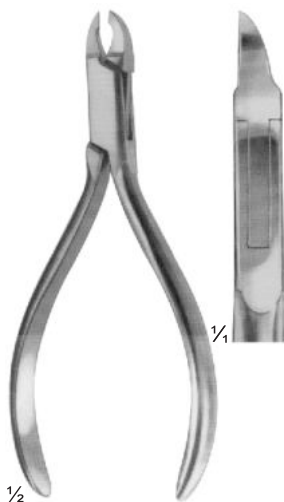

AS-20-101
ANGLE
130 mm

AS-20-102
DUROTIP
ANGLE
130 mm

for soft wire up to diam.	0,5 mm	0,6 mm
for hard wire up to diam.	0,3 mm	0,4 mm

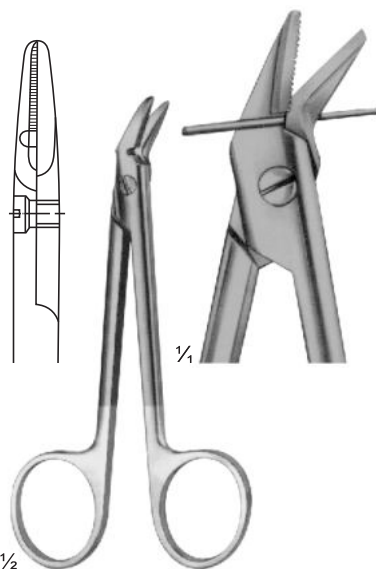

AS-20-103
120 mm

AS-20-104
DUROTIP
120 mm

for soft wire up to diam.	1,2 mm	1,2 mm
for hard wire up to diam.	0,8 mm	0,8 mm

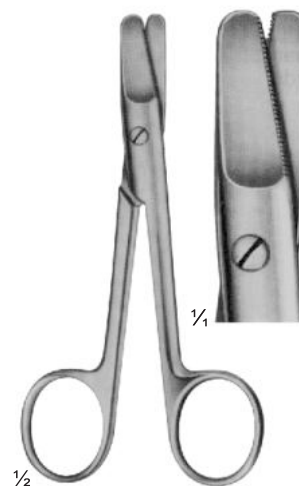

AS-20-105
HARVEY
125 mm

0,4 mm
0,3 mm

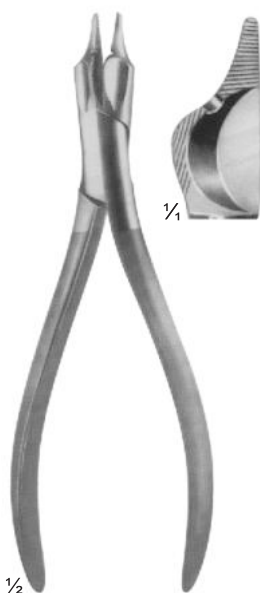

AS-20-106
150 mm

for soft wire up to diam	1,5 mm
for hard wire up to diam	1,0 mm



AS-20-107
160 mm

1,5 mm
1,2 mm



AS-20-108
140 mm

1,5 mm
1,0 mm

WIRE CUTTING PLIERS, LATERAL CUTTING ACTION



ASAMAR
SURGICAL

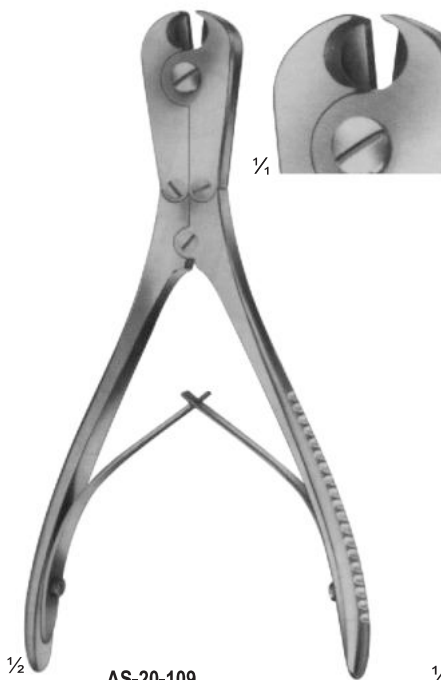

AS-20-109
180 mm

for soft wire
up to diam. 2,0 mm
For hard wire 1,5 mm
up to diam
specially hardened
cutting edges, front
and lateral cutting
action



AS-20-110
REILL
175 mm

for soft wire
up to diam. 2,0 mm
For hard wire 1,6 mm
up to diam
specially hardened
cutting edges, for
cutting off wires close
to the bone



AS-20-111
235 mm

for soft wire
up to diam. 3,0
mm For hard wire 2,2
mm up to diam



KILLIAN
AS-20-112
200 mm



AS-20-113 - AS-20-114
AS-20-113 195 mm
AS-20-114 225 mm



LEBSCHE
AS-20-115
Sternum
chisel 200 mm



AS-20-116
230 mm



COLLIN
AS-20-117
195 mm



GLUCK
AS-20-118
190 mm

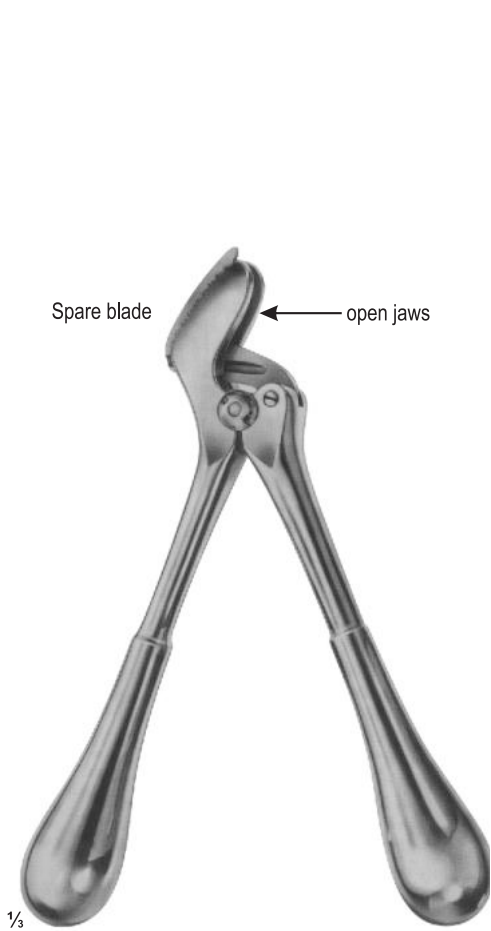

AS-20-119 STILLE-
AESCULAP 260
mm



AS-20-120 STILLE-
AESCULAP 360
mm



Blade with reinforced back



AS-20-121
STILLE 230
mm

AS-20-122
Spare
blade



AS-20-123
STILLE 370
mm

AS-20-124
Spare blade



AS-20-125
STILLE
240 mm

AS-20-126
Spare blade



BEESON
AS-20-127
30 cm



MOD.USA
AS-20-128
23 cm



HAGLUND-STILLE
AS-20-129
20 cm



AS-20-130
29 cm



WOLFF
AS-20-131
10 cm



WOLFF
AS-20-132
24 cm



ASAMAR
SURGICAL 

PAGE

471-499

NEUROSURGERY
LAMINECTOMY

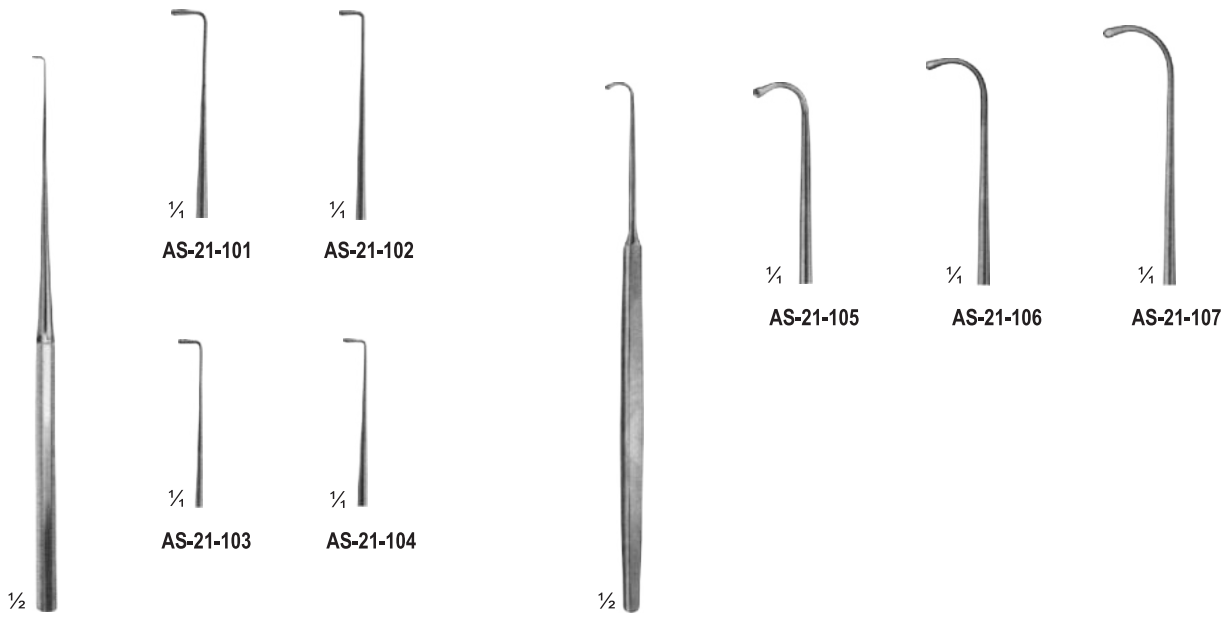

WAGENER
AS-21-101 - AS-21-104
150 mm

GRAEFE
AS-21-105 - AS-21-107
140 mm

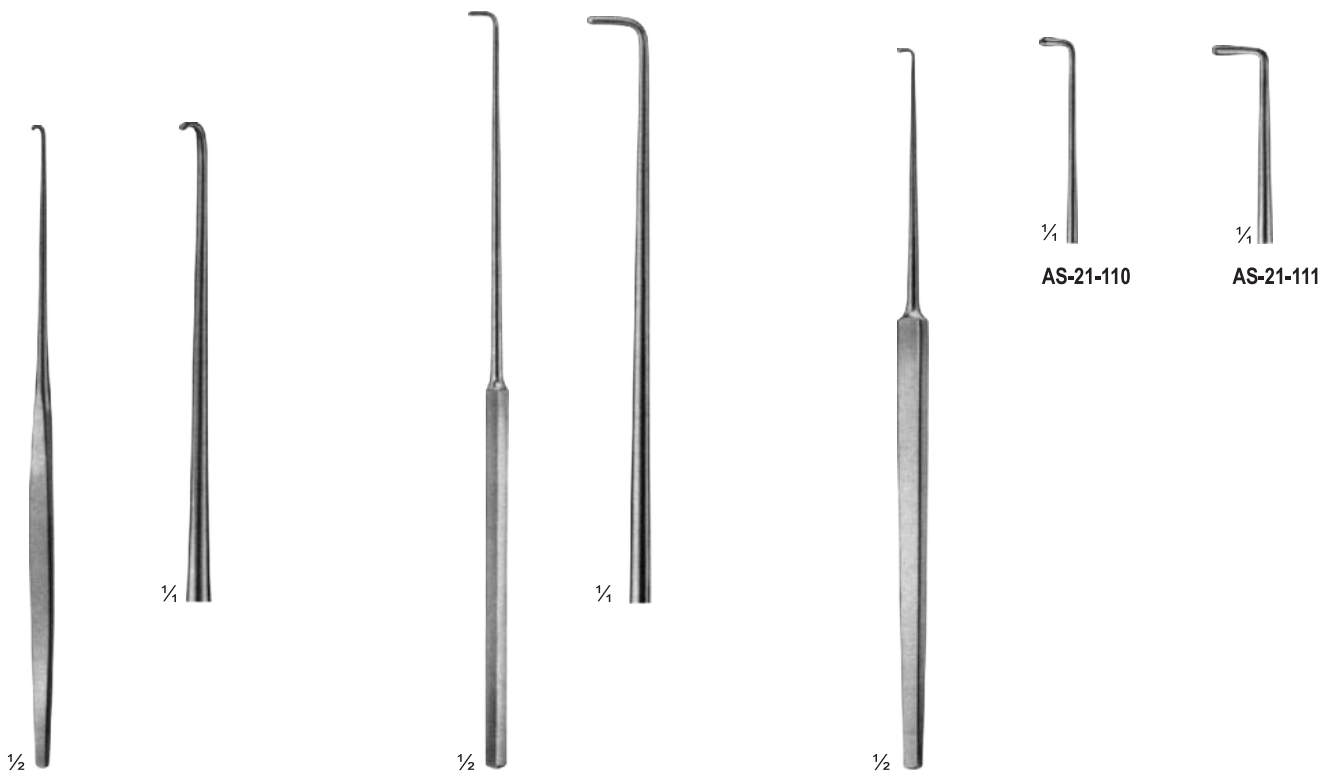

BROM
AS-21-108
Vein hook
170 mm

CRILE
AS-21-109
200 mm

CUSHING
AS-21-110- AS-21-111
190 mm



GRONINGEN
AS-21-112
265 mm

GRONINGEN
AS-21-113
265 mm

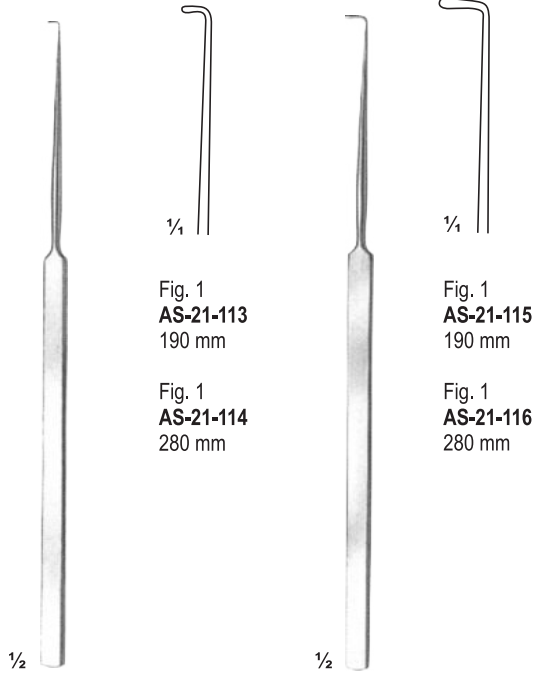

CUSHING
AS-21-113 - AS-21-114

CUSHING
AS-21-115 - AS-21-116

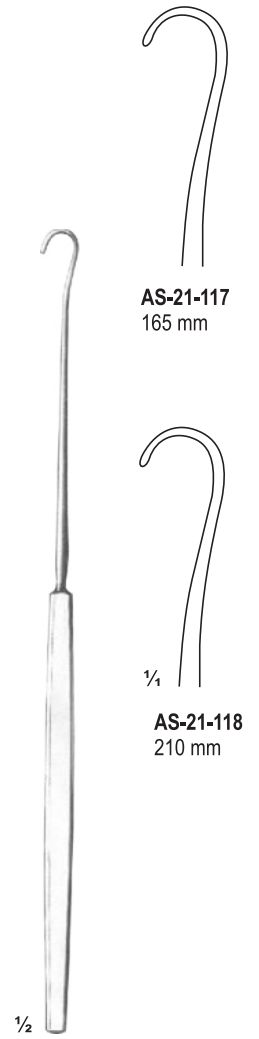

SMITHWICK
AS-21-117 - AS-21-118



1/2

KRAYENBUHI
AS-21-119 - AS-21-122
190 mm



Fig.1
AS-21-119



Fig.2
AS-21-120



Fig.1
AS-21-121



Fig.2
AS-21-122



1/2

CASPER
AS-21-123 - AS-21-126
245 mm



AS-21-123



AS-21-124



AS-21-125



AS-21-126

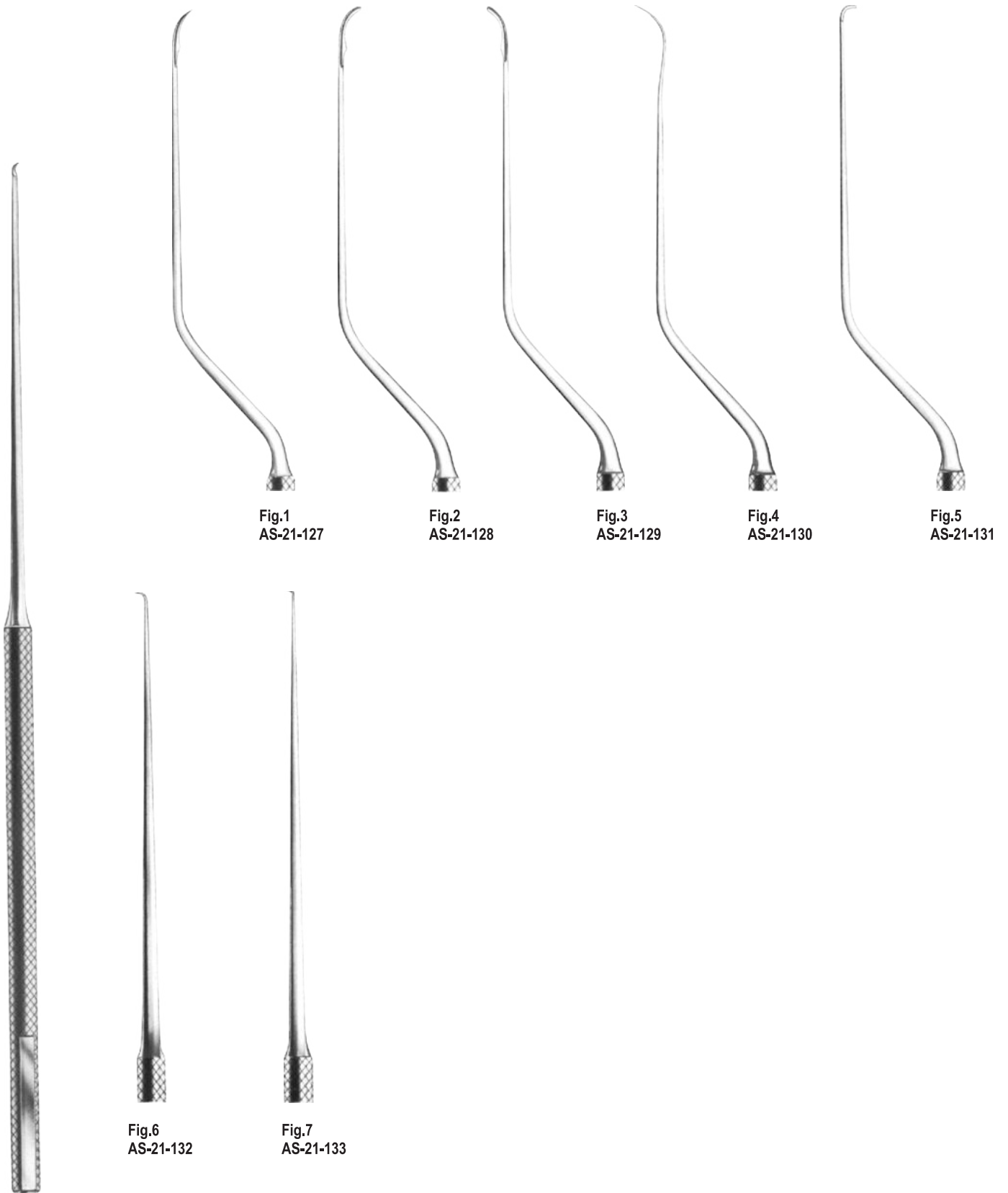

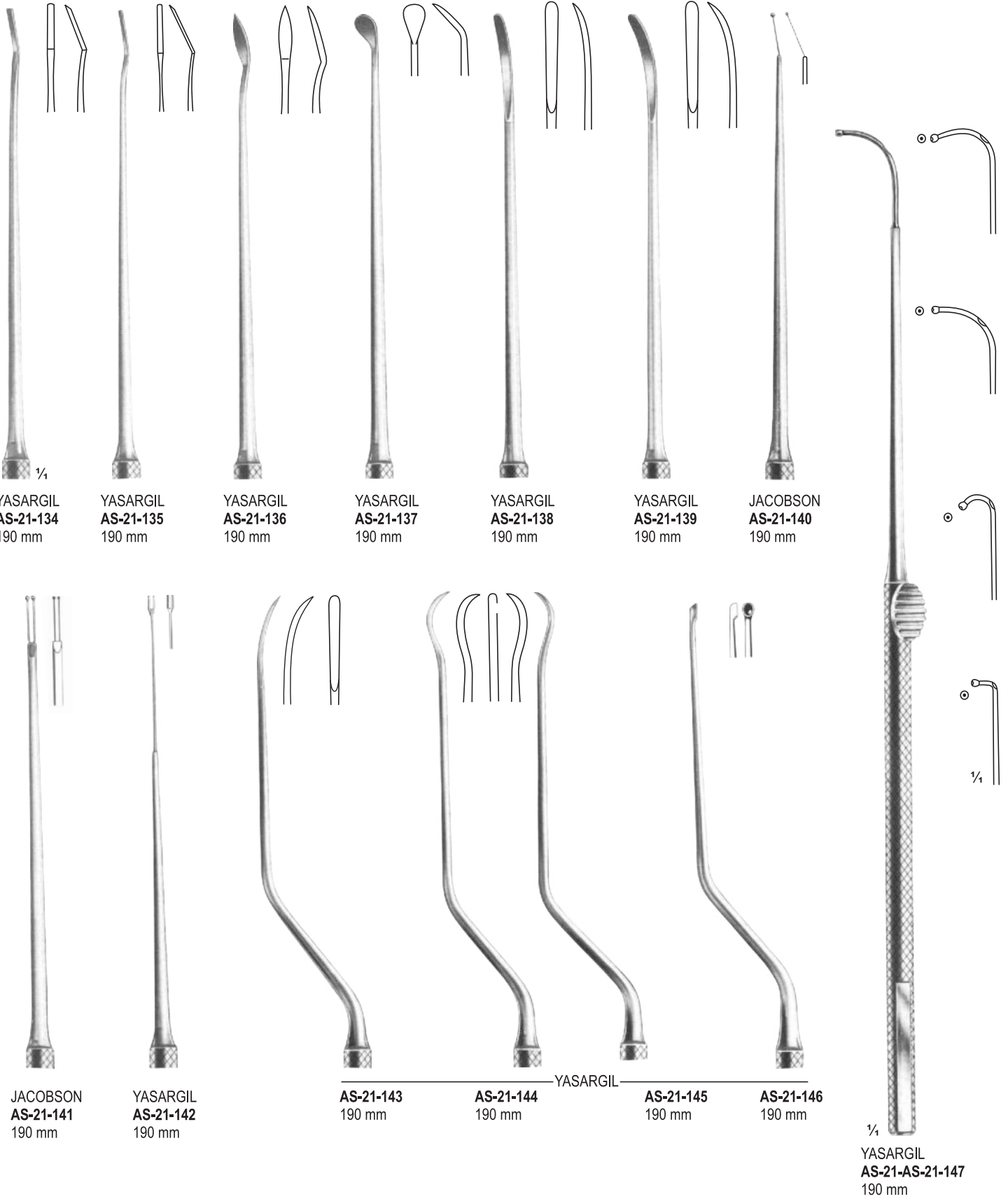



1/2

YASARGIL
AS-21-148 - AS-21-149
Galea Hook



AS-21-148
300 mm



1/4

AS-21-149
410 mm



1/2

TOENNIS
AS-21-150
240 mm



1/4



1/2

OLIVECRONA
AS-21-151
240 mm



1/4





HESS
Nerve Root Retractor
AS-21-152 - AS-21-154
AS-21-152 175 mm 3 mm
AS-21-153 175 mm 5 mm
AS-21-154 175 mm 7 mm



LOVE
Nerve Root Retractor
AS-21-155 - AS-21-157
AS-21-155 190 mm 30°
AS-21-156 190 mm 45°
AS-21-157 190 mm 90°



CASPAR
Nerve Root Retractor
AS-21-158 - AS-21-160
AS-21-158 245 mm 6 mm
AS-21-159 245 mm 8 mm
AS-21-160 245 mm 10 mm



LOVE
AS-21-161
210 mm



SCOVILLE
AS-21-162
235 mm

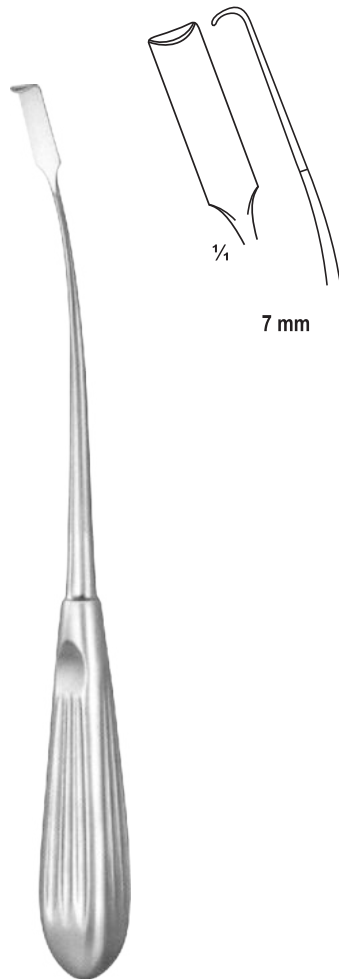

HOLSHER
AS-21-163
240 mm

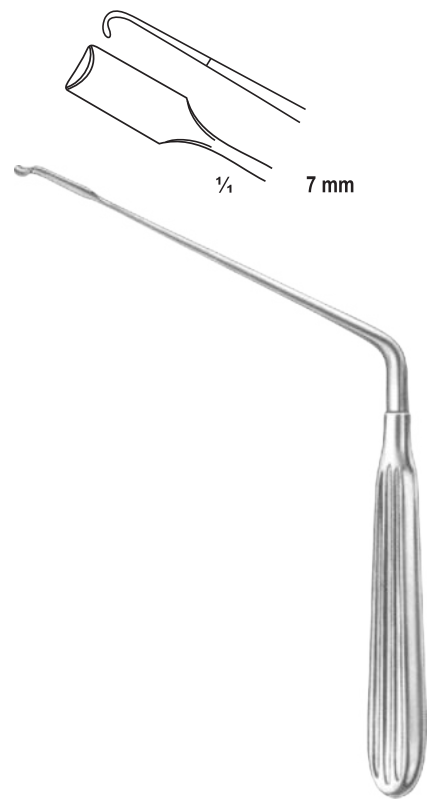

SCOVILLE
AS-21-164
165 mm

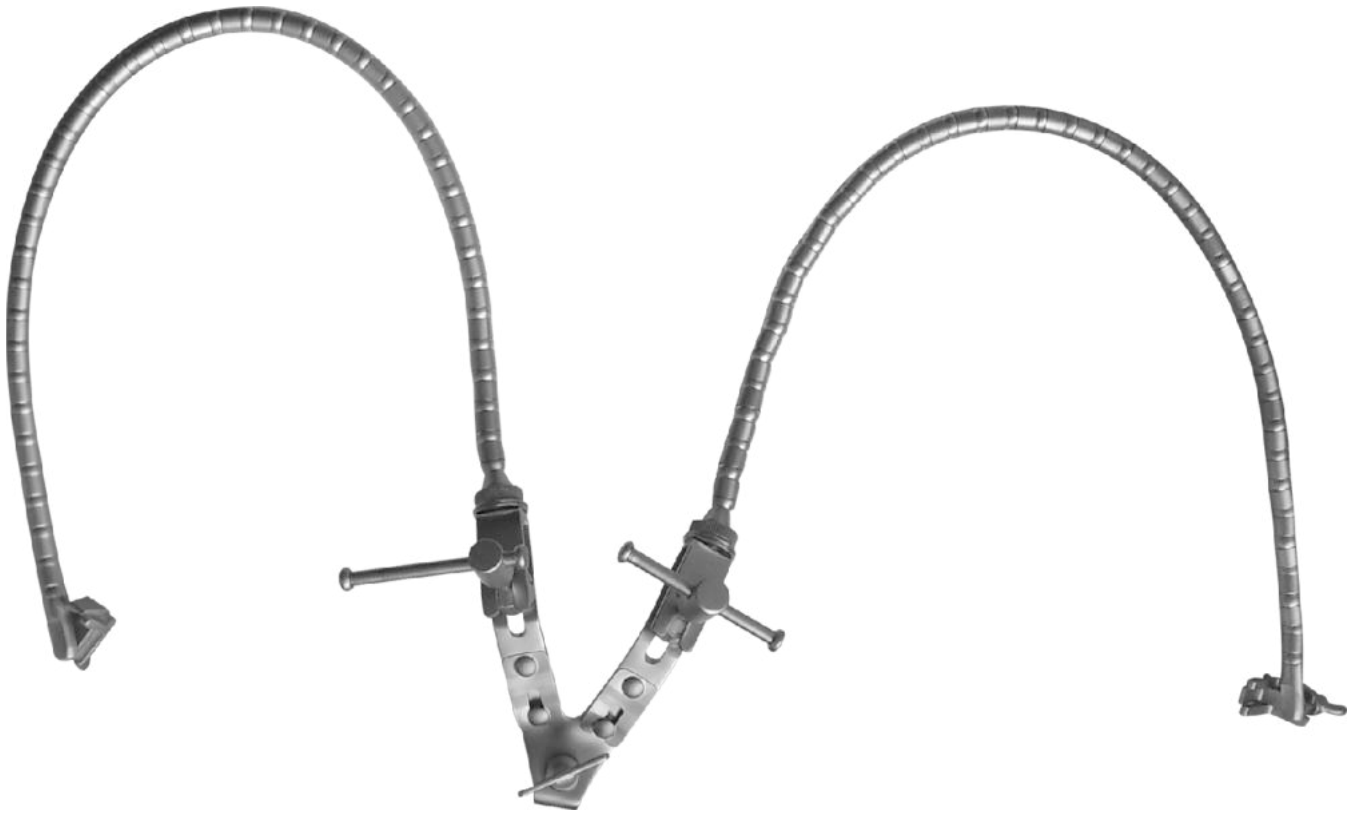

LEYLA
AS-21-165
Self-Retaining brain retractor
with 2 arms complete

LEYLA BED RETRACTOR
AS-21-166
Self-Retaining brain retractor
bed retractor not illustrated

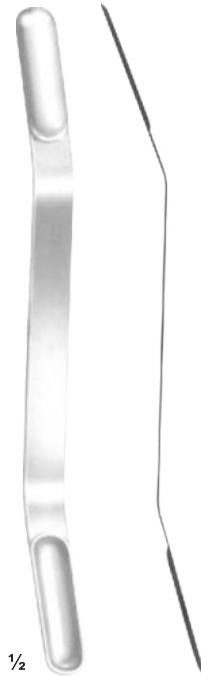

OLIVECRONA
AS-21-167 - AS-21-170
180 mm Concave

- AS-21-167 7 + 9 mm
- AS-21-168 11 + 13 mm
- AS-21-169 15 + 18 mm
- AS-21-170 18 + 22 mm

1/2



AS-21-171
15.5 cm
11 mm

AS-21-172
20 cm
14 mm

AS-21-173
20 cm
17 mm

AS-21-174
20 cm
20 mm

1/2

HEIFETZ
AS-21-171 - AS-21-174

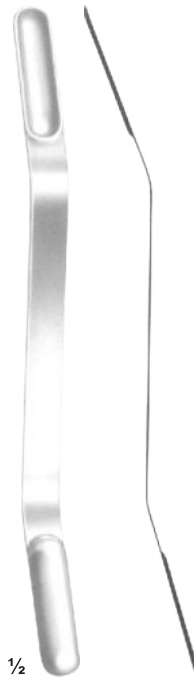

OLIVECRONA
AS-21-175 - AS-21-178
180 mm Convex

- AS-21-175 7 + 9 mm
- AS-21-176 11 + 13 mm
- AS-21-177 15 + 18 mm
- AS-21-178 18 + 22 mm

1/2



AS-21-179
8 mm

AS-21-180
14 mm

AS-21-181
17 mm

1/2

HEIFETZ
AS-21-179 - AS-21-181
155 mm

RETRACTORS FOR CERVICAL VERTEBRAL COLUMN



ASAMAR
SURGICAL



CASPAR AS-21-182
Transverse Retractor hinged
65 mm regular spread
110 mm wide spread



CASPAR AS-21-183
Transverse Retractor double-hinged
65 mm spread



CASPAR AS-21-184
Longitudinal Retractor
double-hinged, ring handle
205 mm
85 mm spread



CASPAR AS-21-185
Specula Retractor single-hinged,
115 mm
70mm regular spread



AS-21-186 - AS-21-194
AS-21-187 23 x 35 mm
AS-21-188 23 x 40 mm
AS-21-189 23 x 45 mm
AS-21-190 23 x 50 mm
AS-21-191 23 x 55 mm
AS-21-192 23 x 60 mm
AS-21-193 23 x 65 mm
AS-21-194 23 x 70 mm
Medial Toothed Blades
Stainless Steel



AS-21-195 - AS-21-199
AS-21-195 15 x 40 mm
AS-21-196 15 x 45 mm
AS-21-197 15 x 50 mm
AS-21-198 15 x 55 mm
AS-21-199 15 x 60 mm
Small Lateral Blades
Stainless Steel



AS-21-200 - AS-21-206
AS-21-200 23 x 40 mm
AS-21-201 23 x 45 mm
AS-21-202 23 x 50 mm
AS-21-203 23 x 55 mm
AS-21-204 23 x 60 mm
AS-21-205 23 x 65 mm
AS-21-206 23 x 70 mm
Lateral Serrated Blades
Stainless Steel



Cervical Blades
Stainless Steel – fenestrated
AS-21-207 - AS-21-208
AS-21-207 25 x 50 mm
AS-21-208 25 x 60 mm



AS-21-209 - AS-21-217
AS-21-209 23 x 35 mm
AS-21-210 23 x 40 mm
AS-21-211 23 x 45 mm
AS-21-212 23 x 50 mm
AS-21-213 23 x 55 mm
AS-21-214 23 x 60 mm
AS-21-215 23 x 65 mm
AS-21-216 23 x 70 mm
AS-21-217 23 x 75 mm
Blunt Blades
Stainless Steel



AS-21-218 - AS-21-222
AS-21-218 23 x 40 mm
AS-21-219 23 x 45 mm
AS-21-220 23 x 50 mm
AS-21-221 23 x 55 mm
AS-21-222 23 x 60 mm
Medial Toothed Blades
Aluminium – rotatating



AS-21-223 - AS-21-227
AS-21-223 23 x 40 mm
AS-21-224 23 x 45 mm
AS-21-225 23 x 50 mm
AS-21-226 23 x 55 mm

AS-21-227 23 x 60 mm
Lateral Serrated Blades
Aluminium – rotatating



AS-21-228 - AS-21-232
AS-21-228 23 x 45 mm
AS-21-229 23 x 50 mm
AS-21-230 3 x 55 mm
AS-21-231 23 x 60 mm
AS-21-232 23 x 65 mm
Blunt Blades
Aluminium – rotatating



**CASPAR
AS-21-233**
Transverse Retractor
hinged 65 mm spread



**CASPAR
AS-21-234**
Specula Retractor single-hinged
115 mm,
70 mm spread



**CASPAR
AS-21-235**
Longitudinal Retractor
single-hinged ring
handle 175 mm
70 mm spread



AS-21-236 - AS-21-243
AS-21-236 20 x 40 mm
AS-21-237 20 x 45 mm
AS-21-238 20 x 50 mm
AS-21-239 20 x 55 mm
AS-21-240 20 x 60 mm
AS-21-241 20 x 65 mm
AS-21-242 20 x 70 mm
AS-21-243 20 x 75 mm
Medial Toothed Blades



AS-21-244 - AS-21-254
AS-21-244 20 x 25 mm
AS-21-245 20 x 30 mm
AS-21-246 20 x 35 mm
AS-21-247 20 x 40 mm
AS-21-248 20 x 45 mm
AS-21-249 20 x 50 mm
AS-21-250 20 x 55 mm
AS-21-251 20 x 60 mm
AS-21-252 20 x 65 mm
AS-21-253 20 x 70 mm
AS-21-254 20 x 75 mm
Lateral Serrated Blades



AS-21-255 - AS-21-264
AS-21-255 20 x 30 mm
AS-21-256 20 x 35 mm
AS-21-257 20 x 40 mm
AS-21-258 20 x 45 mm
AS-21-259 20 x 50 mm
AS-21-260 20 x 55 mm
AS-21-261 20 x 60 mm
AS-21-262 20 x 65 mm
AS-21-263 20 x 70 mm
AS-21-264 20 x 75 mm
Blunt Blades



AS-21-265 - AS-21-272
AS-21-265 20 x 35 mm
AS-21-266 20 x 40 mm
AS-21-267 20 x 45 mm
AS-21-268 20 x 50 mm
AS-21-269 20 x 55 mm
AS-21-270 20 x 60 mm
AS-21-271 20 x 65 mm
AS-21-272 0 x 70 mm
Medial Toothed Blades
fenestrated



AS-21-273 - AS-21-282
AS-21-273 20 x 25 mm
AS-21-274 20 x 30 mm
AS-21-275 20 x 35 mm
AS-21-276 20 x 40 mm
AS-21-277 20 x 45 mm
AS-21-278 20 x 50 mm
AS-21-279 20 x 55 mm
AS-21-280 20 x 60 mm
AS-21-281 20 x 65 mm
AS-21-282 20 x 70 mm
Lateral Serrated Blades
Fenestrated



AS-21-283 - AS-21-291
AS-21-283 20 x 35 mm
AS-21-284 20 x 40 mm
AS-21-285 20 x 45 mm
AS-21-286 20 x 50 mm
AS-21-287 20 x 55 mm
AS-21-288 20 x 60 mm
AS-21-289 20 x 65 mm
AS-21-290 20 x 70 mm
AS-21-291 20 x 75 mm
Blunt Blades Fenestrated



CASPAS
AS-21-292
Transverse Retractor
hinged 60 mm spread



CASPAS
AS-21-293
Transverse Retractor double-
hinged 65 mm spread



CASPAS
AS-21-294
Longitudinal Retractor
single-hinged ring handle
175 mm
70 mm spread



CASPAS
AS-21-295
Longitudinal Retractor
single-hinged ring handle
175 mm
70 mm spread



AS-21-296 - AS-21-302
AS-21-296 12 x 40 mm
AS-21-297 12 x 45 mm
AS-21-298 12 x 50 mm
AS-21-299 12 x 55 mm
AS-21-300 12 x 60 mm
AS-21-301 12 x 65 mm
AS-21-302 12 x 75 mm
 Small Lateral Serrated
 Blades PEEK



AS-21-303 - AS-21-309
AS-21-303 23 x 40 mm
AS-21-304 23 x 45 mm
AS-21-305 23 x 50 mm
AS-21-306 23 x 55 mm
AS-21-307 23 x 60 mm
AS-21-308 23 x 65 mm
AS-21-309 23 x 75 mm
 Lateral Serrated Blades
 PEEK



AS-21-310 - AS-21-316
AS-21-310 23 x 40 mm
AS-21-311 23 x 45 mm
AS-21-312 23 x 50 mm
AS-21-313 23 x 55 mm
AS-21-314 23 x 60 mm
AS-21-315 23 x 65 mm
AS-21-316 23 x 75 mm
 Blunt Blades PEEK



AS-21-317 - AS-21-323
AS-21-317 23 x 40 mm
AS-21-318 23 x 45 mm
AS-21-319 23 x 50 mm
AS-21-320 23 x 55 mm
AS-21-321 23 x 60 mm
AS-21-322 23 x 65 mm
AS-21-323 23 x 75 mm
 Medial Toothed Blades
 PEEK



AS-21-324 - AS-21-330
AS-21-324 23 x 40 mm
AS-21-325 23 x 45 mm
AS-21-326 23 x 50 mm
AS-21-327 23 x 55 mm
AS-21-328 23 x 60 mm
AS-21-329 23 x 65 mm
AS-21-330 23 x 75 mm
 Lateral Serrated Blades
 PEEK – rotatating



AS-21-331 - AS-21-337
AS-21-331 23 x 40 mm
AS-21-332 23 x 45 mm
AS-21-333 23 x 50 mm
AS-21-334 23 x 55 mm
AS-21-335 23 x 60 mm
AS-21-336 23 x 65 mm
AS-21-337 23 x 75 mm
 Blunt Blades
 PEEK – rotatating

RETRACTORS FOR CERVICAL VERTEBRAL COLUMN



CASPAR
AS-21-338
Transverse Retractor double-hinged
quick connect 72 mm spread, side-loading



CASPAR
AS-21-339
Longitudinal Retractor double-hinged,
ring handle, quick connect
185 mm
75 mm spread, side-loading



CASPAR
AS-21-340
Specula Retractor single-hinged,
quick connect
115 mm
70 mm spread, side-loading



CASPAR
AS-21-341
Quick Connect Blade
Positioner Handle
210 mm
for quick connect
blades only



AS-21-342 - AS-21-346
AS-21-342 23 x 40 mm
AS-21-343 23 x 45 mm
AS-21-344 23 x 50 mm
AS-21-345 23 x 55 mm
AS-21-346 23 x 60 mm
Medial Toothed Blades
Stainless Steel
quick connect



AS-21-347 - AS-21-351
AS-21-347 23 x 40 mm
AS-21-348 23 x 45 mm
AS-21-349 23 x 50 mm
AS-21-350 23 x 55 mm
AS-21-351 23 x 60 mm
Lateral Serrated Blades
Stainless Steel
quick connect



AS-21-352 - AS-21-356
AS-21-352 23 x 45 mm
AS-21-353 23 x 50 mm
AS-21-354 23 x 55 mm
AS-21-355 23 x 60 mm
AS-21-356 23 x 65 mm
Blunt Blades
Stainless Steel
quick connect



AS-21-357 - AS-21-361
AS-21-357 23 x 40 mm
AS-21-358 23 x 45 mm
AS-21-359 23 x 50 mm
AS-21-360 23 x 55 mm
AS-21-361 23 x 60 mm
Medial Toothed Blades
Titanium
quick connect



AS-21-362 - AS-21-366
AS-21-362 23 x 40 mm
AS-21-363 23 x 45 mm
AS-21-364 23 x 50 mm
AS-21-365 23 x 55 mm
AS-21-366 23 x 60 mm
Lateral Serrated Blades
Titanium
quick connect



AS-21-367 - AS-21-371
AS-21-367 23 x 45 mm
AS-21-368 23 x 50 mm
AS-21-369 23 x 55 mm
AS-21-370 23 x 60 mm
AS-21-371 23 x 65 mm
Blunt Blades Titanium
quick connect



CASPAR

AS-21-372

Caspar Cervical Spine Retractor
stainless steel, complete set for transverse retraction, 65 mm
spread, adjustable, with 5 medial and 5 lateral stainless
steel, blades 40, 45, 50, 55, 60 mm

AS-21-373

TI Caspar Cervical Spine Retractor
titanium, complete set for transverse retraction, 65 mm
spread, adjustable, with 5 medial and 5 lateral titanium
blades 40, 45, 50, 55, 60 mm



CASPAR AS-21-374
Caspar Microdiscectomy
Retractor for microsurgical
treatment of herniated lumbar
discs
45 mm spread



AS-21-375 - AS-21-383
AS-21-375 35 mm
AS-21-376 40 mm
AS-21-377 45 mm
AS-21-378 50 mm
AS-21-379 55 mm
AS-21-380 60 mm
AS-21-381 65 mm
AS-21-382 75 mm
AS-21-383 85 mm
Lateral Blades



AS-21-384 - AS-21-390
AS-21-384 40 mm
AS-21-385 45 mm
AS-21-386 50 mm
AS-21-387 55 mm
AS-21-388 60 mm
AS-21-389 65 mm
AS-21-390 70 mm
Paraspina Blades



CASPAR
AS-21-391 - AS-21-400
AS-21-391 40 mm
AS-21-392 45 mm
AS-21-393 50 mm
AS-21-394 55 mm
AS-21-395 60 mm
AS-21-396 65 mm
AS-21-397 70 mm
AS-21-398 75 mm
AS-21-399 80 mm
AS-21-400 85 mm
Lumbar Speculum
fenestrated



AS-21-405 - AS-21-410
AS-21-405 20 x 30 mm
AS-21-406 20 x 40 mm
AS-21-407 20 x 50 mm
AS-21-408 20 x 60 mm
AS-21-409 20 x 70 mm
AS-21-410 20 x 80 mm
 McCulloch 4-teeth
 Narrow Muscle Blades



AS-21-411 - AS-21-416
AS-21-411 20 x 30 mm
AS-21-412 20 x 40 mm
AS-21-413 20 x 50 mm
AS-21-414 20 x 60 mm
AS-21-415 20 x 70 mm
AS-21-416 20 x 80 mm
 McCulloch 6-teeth
 Wide Muscle Blades

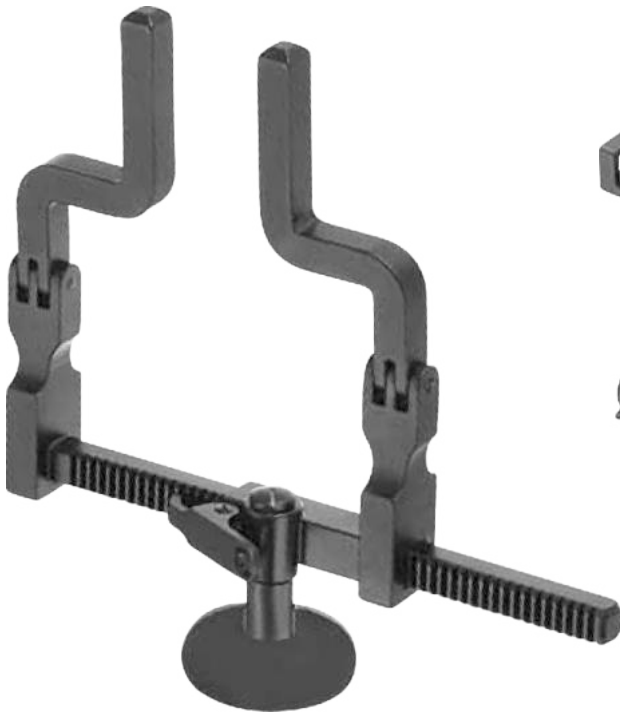

CASPAR
 McCulloch Lumbar Spine Retractor for Microdiscectomy,
 black silicone bead

AS-21-401 68 mm spread, hinged

AS-21-402 68 mm spread, rigid

AS-21-403 90 mm spread, rigid

McCulloch Lumbar Spine Retractor Tray

AS-21-404 Tray 265 x 265 mm for Container (not
 illustrated)



AS-21-417 - AS-21-422
AS-21-417 20 x 30 mm
AS-21-418 20 x 40 mm
AS-21-419 20 x 50 mm
AS-21-420 20 x 60 mm
AS-21-421 20 x 70 mm
AS-21-422 20 x 80 mm
 McCulloch 2-teeth
 Thin Muscle Blades



AS-21-423 - AS-21-430
AS-21-423 20 mm
AS-21-424 30 mm
AS-21-425 40 mm
AS-21-426 50 mm
AS-21-427 60 mm
AS-21-428 70 mm
AS-21-429 80 mm
AS-21-430 90 mm
 McCulloch Hook
 Blades



AS-21-431 - AS-21-438
AS-21-431 20 mm
AS-21-432 30 mm
AS-21-433 40 mm
AS-21-434 50 mm
AS-21-435 60 mm
AS-21-436 70 mm
AS-21-437 80 mm
AS-21-438 90 mm
 McCulloch toothed
 Hook Blades



AS-21-439 - AS-21-441
AS-21-439 20 x 50 mm
AS-21-440 20 x 60 mm
AS-21-441 20 x 70 mm
 McCulloch 2-teeth
 Cervical Blades

RETRACTORS FOR CERVICAL VERTEBRAL COLUMN



ASAMAR
SURGICAL



CASPAR
AS-21-442 - AS-21-443
Caspar Vertebral Column Retractor for Laminectomy and Hemilaminectomy (Lumbar, Thoracic, Cervical), stainless steel, complete set, 145 mm spread,
AS-21-442 125 mm arms, consisting of
AS-21-443 145 mm spread, hinged includes Screw Driver for spreading bar

CASPAR
AS-21-444
Screw driver for spreading bar

CASPAR **AS-21-445**
Blade Changing Forceps 115 mm



AS-21-446 - AS-21-447
AS-21-446 38 mm
AS-21-447 58 mm

AS-21-448 - AS-21-455
AS-21-448 22 x 32 mm
AS-21-449 22 x 37 mm
AS-21-450 22 x 43 mm
AS-21-451 22 x 47 mm
AS-21-452 22 x 52 mm
AS-21-453 22 x 57 mm
AS-21-454 22 x 62 mm
AS-21-455 22 x 67 mm

AS-21-456 - AS-21-463
AS-21-456 37 x 32 mm
AS-21-457 37 x 37 mm
AS-21-458 37 x 43 mm
AS-21-459 37 x 47 mm
AS-21-460 37 x 52 mm
AS-21-461 37 x 57 mm
AS-21-462 37 x 62 mm
AS-21-463 37 x 67 mm

AS-21-464 - AS-21-471
AS-21-464 57 x 32 mm
AS-21-465 57 x 37 mm
AS-21-466 57 x 43 mm
AS-21-467 57 x 47 mm
AS-21-468 57 x 52 mm
AS-21-469 57 x 57 mm
AS-21-470 57 x 62 mm
AS-21-471 57 x 67 mm



**CASPAR
AS-21-472**

Distractor only for use in surgical procedures from the left approach the right approach for the upper cervical spine Distractor as above but with elongated toothed bar for multilevel (more than 2) distraction

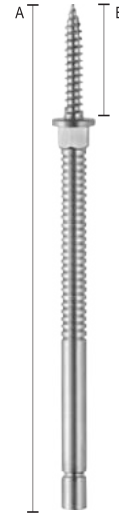

**DISTRACTION PIN A/B
AS-21-473 - AS-21-476**
AS-21-473 66/12 mm
AS-21-474 68/14 mm
AS-21-475 70/16 mm
AS-21-476 72/18 mm



**TWIST DRILL
AS-21-477**



**DRILL GUIDE
AS-21-478**



**SCREW DRIVER
AS-21-479**



**CASPAR
AS-21-480**
Distractor only for use in surgical procedures from the left approach the right approach for the upper cervical spine Distractor as above but with elongated toothed bar for multilevel (more than 2) distraction

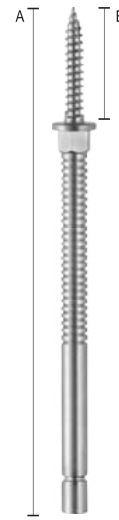

**DISTRACTION PIN A/B
AS-21-481 - AS-21-484**
AS-21-481 66/12 mm
AS-21-482 68/14 mm
AS-21-483 70/16 mm
AS-21-484 72/18 mm



**TWIST DRILL
AS-21-485**



**DRILL GUIDE
AS-21-486**



**SCREW DRIVER
AS-21-487**



CLOWARD-TYPE
AS-21-488
Vertebra Spreaders
130 mm
18 mm spread



AS-21-489
one pointed tip
70 mm
arm, 80 mm
spread



three pointed tips
AS-21-490
850 mm arm,
70 mm spread
AS-21-491
100 mm
arm, 70 mm
spread



INGE
Lamina Spreaders
AS-21-492 - AS-21-493
AS-21-492 165 mm
AS-21-493 270 mm

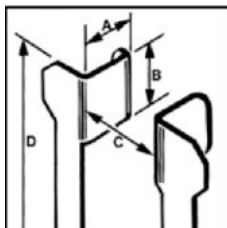

SCOVILLE-HAVERFIELD

	A	B	C	D
AS-21-494	50 mm	35 mm	140 mm	140 mm
with 1 each blade 29-3165.50 and 29-3162.51				
Frame only, hinged:				
AS-21-495			140 mm	140 mm



Toothed:

- AS-21-502 - AS-21-507**
- AS-21-502** 63 mm x 26 mm
- AS-21-503** 66 mm x 30 mm
- AS-21-504** 89 mm x 26 mm
- AS-21-505** 51 mm x 51 mm
- AS-21-506** 63 mm x 51 mm
- AS-21-507** 76 mm x 51 mm



3-prongs:

AS-21-496 44 mm x 38 mm

4-prongs:

AS-21-497 - AS-21-501

AS-21-497 41 mm x 38 mm

AS-21-498 66 mm x 48 mm

AS-21-499 48 mm x 51 mm

AS-21-500 63 mm x 63 mm

AS-21-501 82 mm x 58 mm



Hook-shaped, blunt:

AS-21-508 - AS-21-509

AS-21-508 50 mm

AS-21-509 75 mm



Williams AS-21-510
for microsurgical treatment
of herniated discs
170 mm
w = 10 mm
AS-21-511 10 x 50 mm
AS-21-512 10 x 60 mm
AS-21-513 10 x 70 mm

w = 20 mm
AS-21-514 20 x 50 mm
AS-21-515 20 x 60 mm
AS-21-516 20 x 70 mm



Williams AS-21-517
for microsurgical treatment
of herniated discs
170 mm
w = 10 mm
AS-21-518 10 x 50 mm
AS-21-519 10 x 60 mm
AS-21-520 10 x 70 mm

w = 20 mm
AS-21-521 20 x 50 mm
AS-21-522 20 x 60 mm
AS-21-523 20 x 70 mm



CLOWARD-TYPE
AS-21-524
 with slide lock Cervical Retractor Set with slide-lock complete with 14 blades, 25 cm
AS-21-525 – AS-21-526
AS-21-527 Retractor Body only (without blades), 25 cm



AS-21-528
 Cervical Retractor Set with slide-lock complete with 14 blades, 16 cm
AS-21-529 – AS-21-530
AS-21-531 Retractor Body only (without blades), 160 mm



AS-21-532 - AS-21-538
AS-21-532 25 mm
AS-21-533 30 mm
AS-21-534 35 mm
AS-21-535 40 mm
AS-21-536 45 mm
AS-21-537 50 mm
AS-21-538 55 mm
 blunt



AS-21-539 - AS-21-545
AS-21-539 25 mm
AS-21-540 30 mm
AS-21-541 35 mm
AS-21-542 40 mm
AS-21-543 45 mm
AS-21-544 50 mm
AS-21-545 55 mm
 blunt

Galea Hooks



YASARGIL
AS-21-546
31 cm

YASARGIL
AS-21-547
41 cm

Dura Protecting Forceps

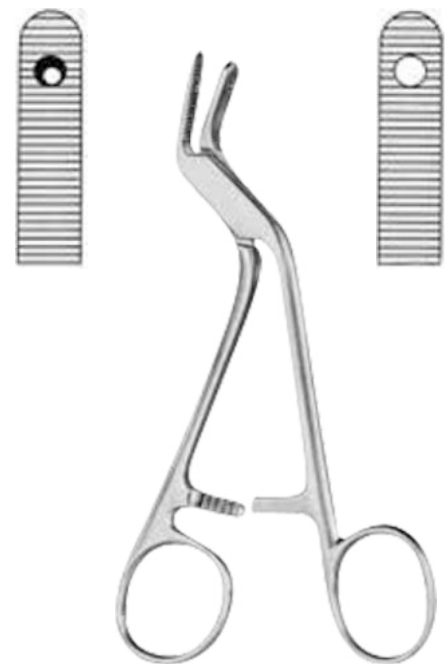

ADSON
AS-21-548
15 cm



AS-21-549
Silver Wires Mckenzie

Elio Carrier



MCKENZIE
AS-21-550
148x40x60 mm
One Clip
Holding



MCKENZIE
AS-21-551
190x48x13 mm
Two Clips
Holding

Silver Clips



AS-21-552

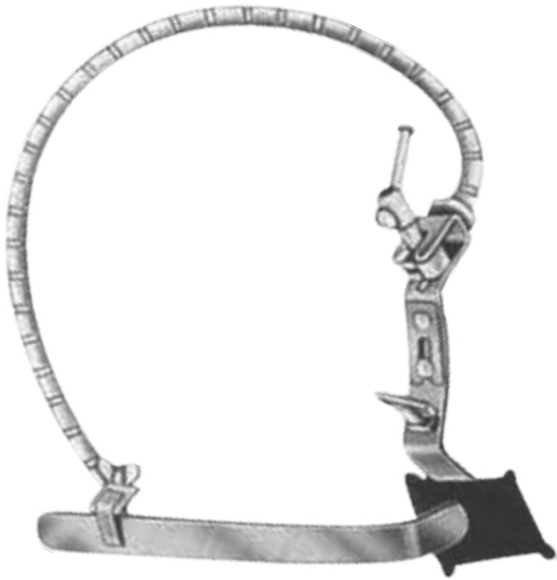

AS-21-553
Complete Brain Retractor
Set With 1 Arm



AS-21-555
Complete Set

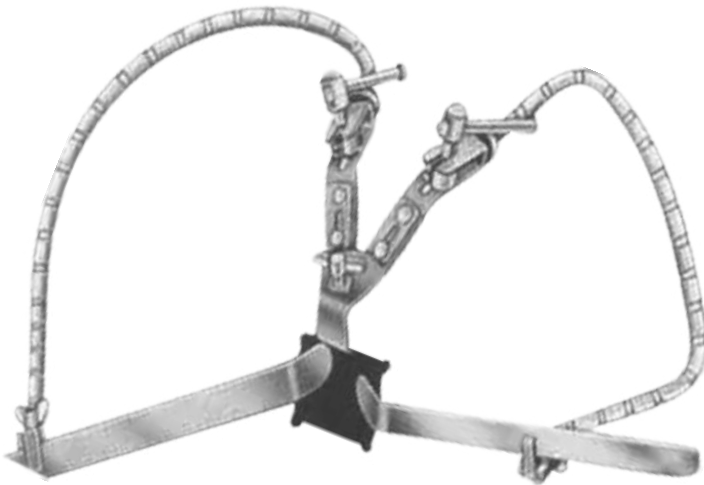

AS-21-554
Complete Brain Retractor
Set With 2 Arm

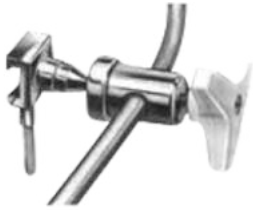

AS-21-556
Ball and Socket Joint



AS-21-557
Holding Rod, Head



AS-21-558
Coupling Head



AS-21-559
Fixation Base for skull
Mounting Holding 1
Flexible Arm



AS-21-560
Fixation Base for skull
Mounting, Holding 2
Flexible Arms



AS-21-561
Fixation Base for
Mounting to 16 mm Dia.
Holding 1 Flexible Arm

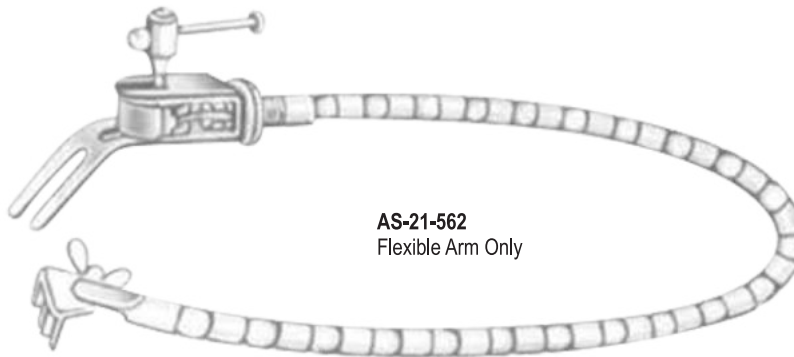

AS-21-562
Flexible Arm Only



AS-21-563
Support for Flat
Brain Spatula



AS-21-564
Support for Brain Spatula
With Round Shaft



AS-21-565
Held for Ear Spatula



ASAMAR
SURGICAL 

PAGE

500-534

**ABDOMINAL SURGERY
INTESTINAL & RECTAL
INSTRUMENTS**

INTESTINAL AND TISSUE GRASPING FORCEPS

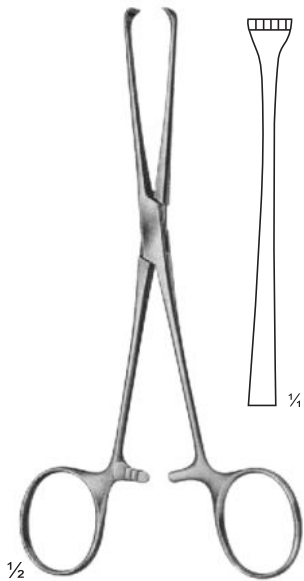

1/2

AS-22-101
BOYS-ALLIS
5 X 6 teeth, sharp
155 mm,

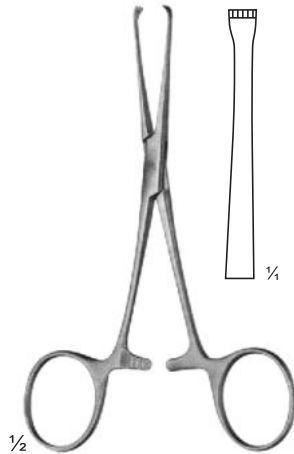

1/2

AS-22-102
ALLIS
4 X 5 teeth
155 mm,

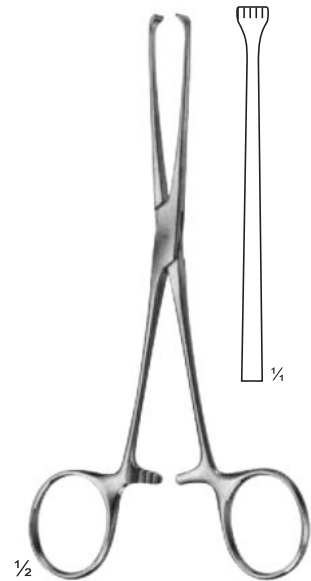

1/2

AS-22-103
ALLIS
155 mm,
4 X 5 teeth

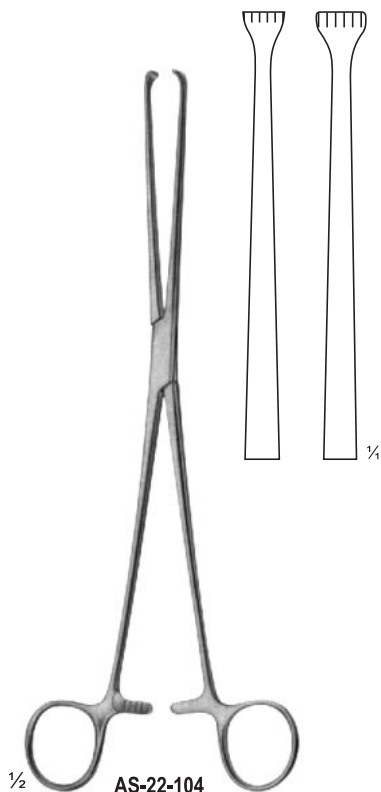

1/2

AS-22-104
ALLIS
190 mm,
AS-22-105
255 mm,
5 X 6 teeth

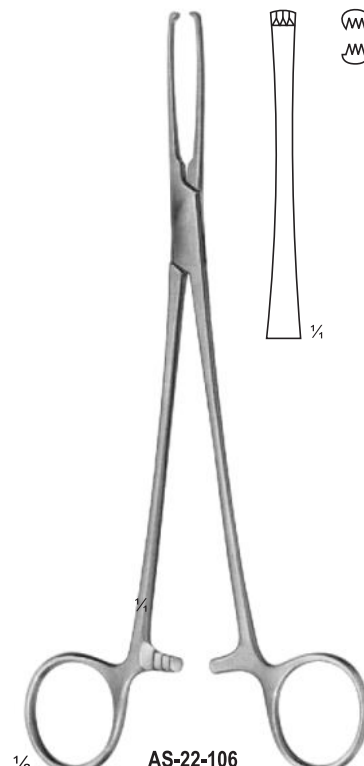

1/2

AS-22-106
JUDD-ALLIS
3 X 4 teeth
195 mm,

INTESTINAL GRASPING FORCEPS

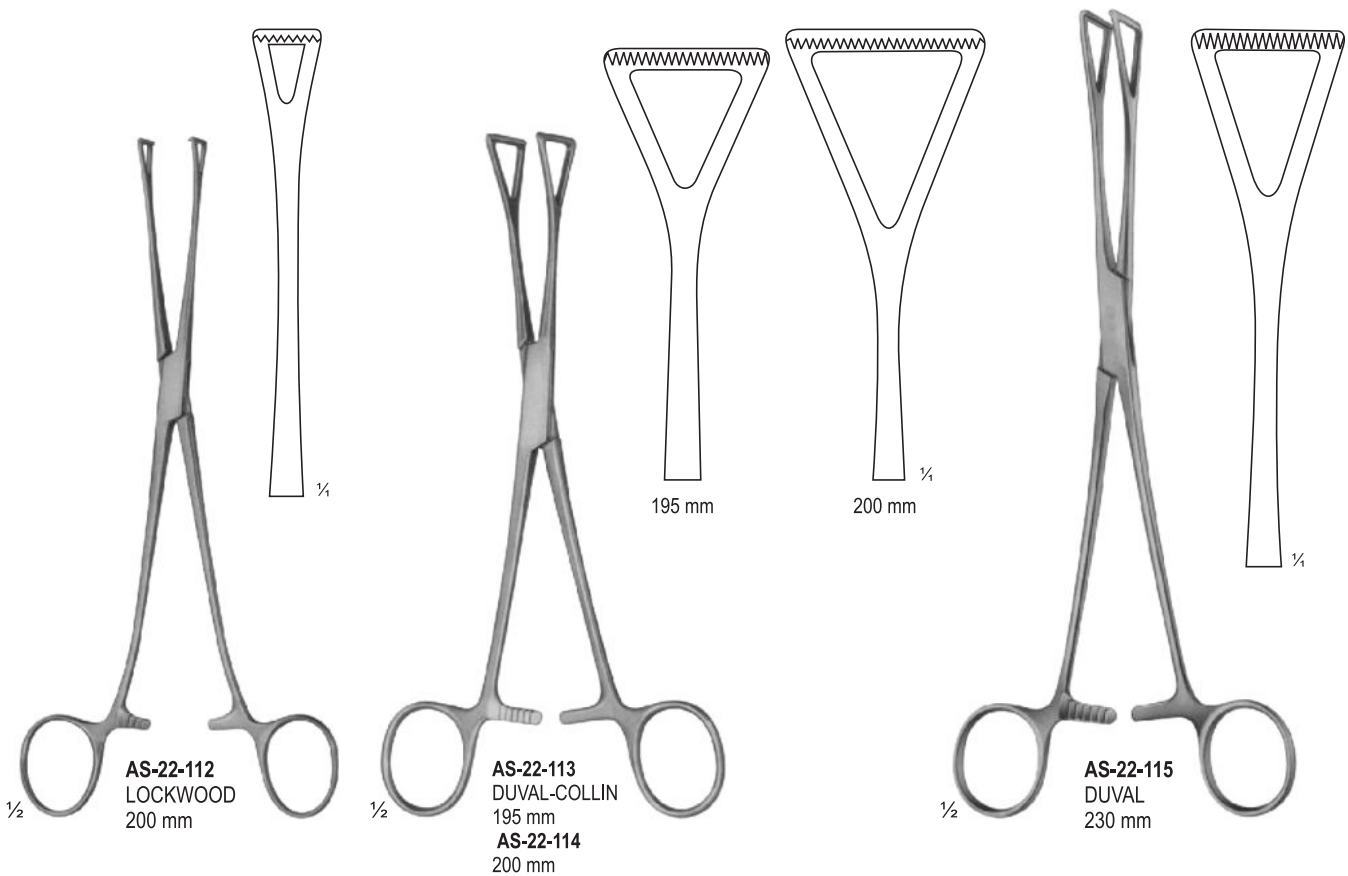
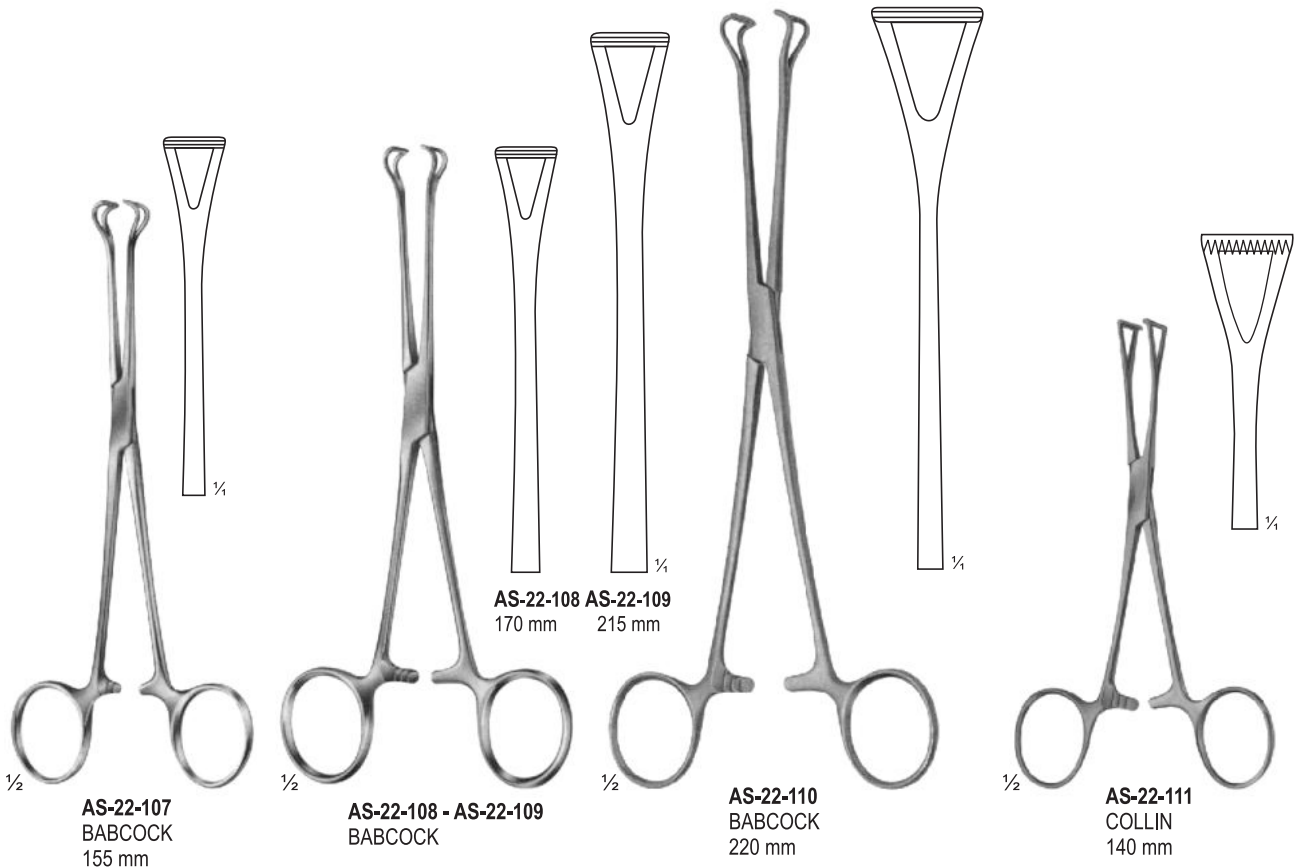

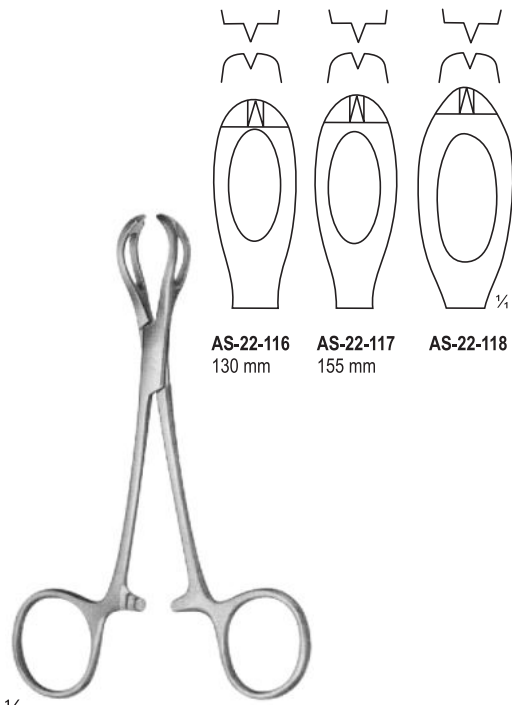

AS-22-116 130 mm
AS-22-117 155 mm
AS-22-118

1/2
AS-22-116 - AS-22-118
LANE

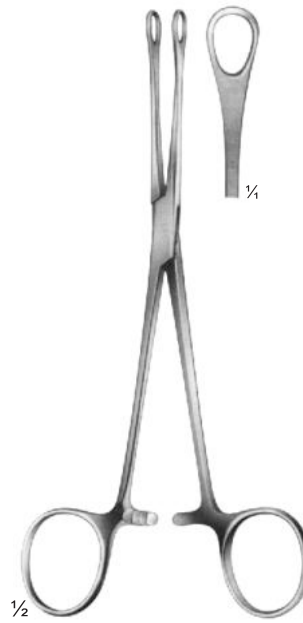

AS-22-119
WILLIAMS
160 mm

1/2



AS-22-120
DENIS
BROWNE
190 mm

1/2

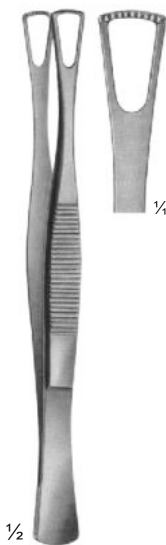

AS-22-121
DUVAL 140
mm

1/2



AS-22-122 AS-22-123
DUROGRIP

1/2

AS-22-122
WANGENSTEEN
150 mm AS-22-
123
230 mm



AS-22-124
WANGENSTEEN
150 mm AS-22-
125
230 mm

1/2

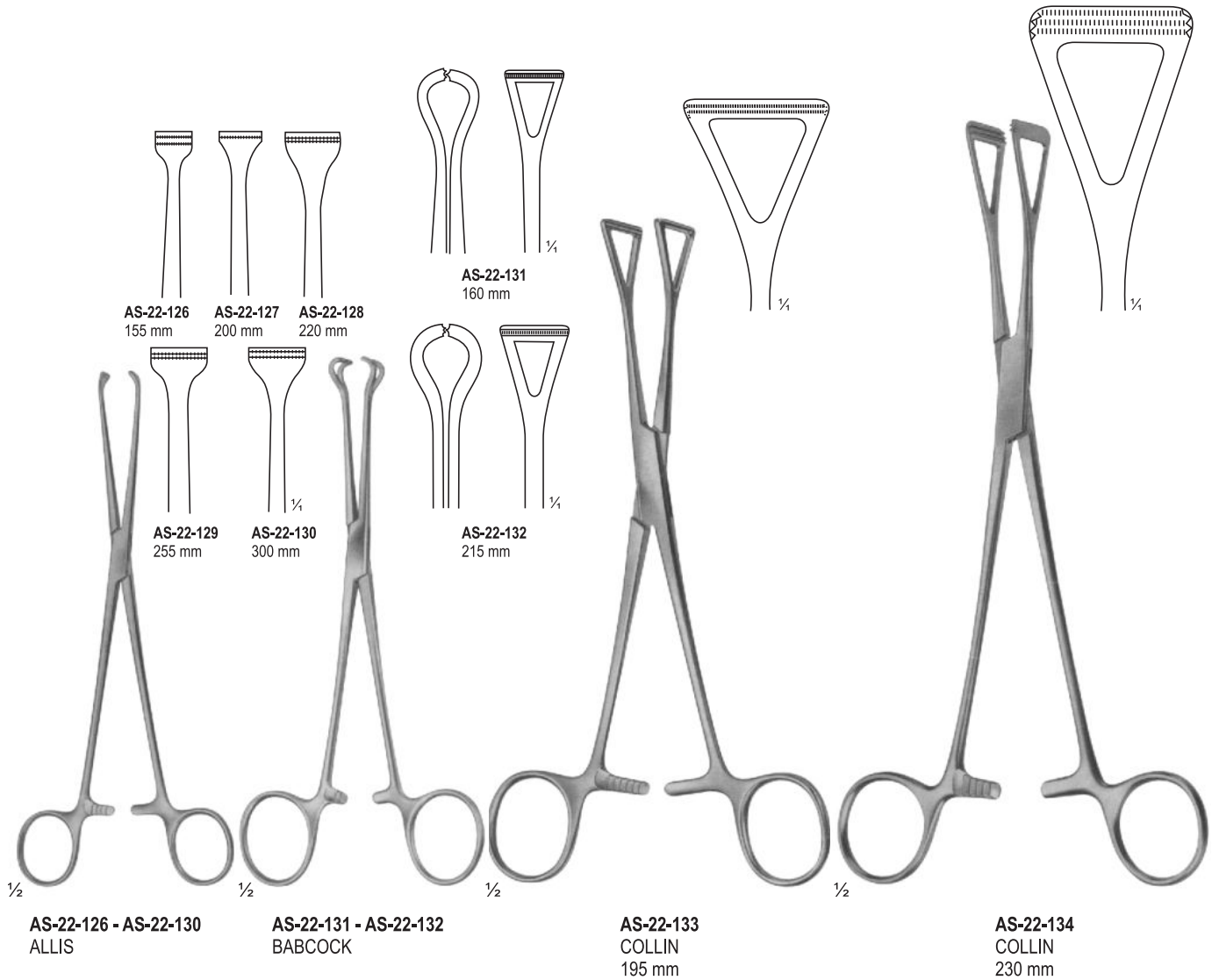

ULTRA - LIGHT - FORCEPS, DISSECTING FORCEPS



ASAMAR
SURGICAL



AS-22-135 1,2 mm
AS-22-136 1,5 mm
AS-22-137 1,5 mm
AS-22-138 1,5 mm

½

AS-22-135 150 mm
AS-22-136 200 mm
AS-22-137 240 mm
AS-22-138 300 mm



AS-22-139 2 mm
AS-22-140 2 mm
AS-22-141 2 mm
AS-22-142 2mm

½

DE BAKEY **AS-22-139** 150 mm
AS-22-140 200 mm
AS-22-141 240 mm
AS-22-142 300 mm



AS-22-143 2,8 mm
AS-22-144 2,8 m
AS-22-145 2,8 mm
AS-22-146 2,8 mm

½

DE BAKEY **AS-22-143** 150 mm
AS-22-144 200 mm
AS-22-145 240 mm
AS-22-146 300 mm

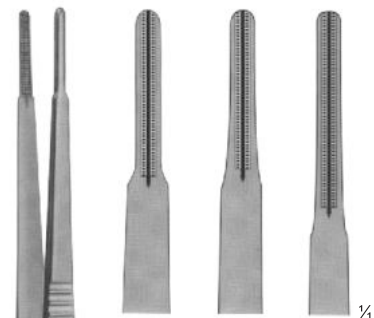

AS-22-147 3,3 mm
AS-22-148 3,3mm
AS-22-149 3,3mm

½

DE BAKEY **AS-22-147** 200 mm
AS-22-148 240 mm
AS-22-149 300 mm

INTESTINAL CLAMPS FOR CHILDREN



ASAMAR
SURGICAL

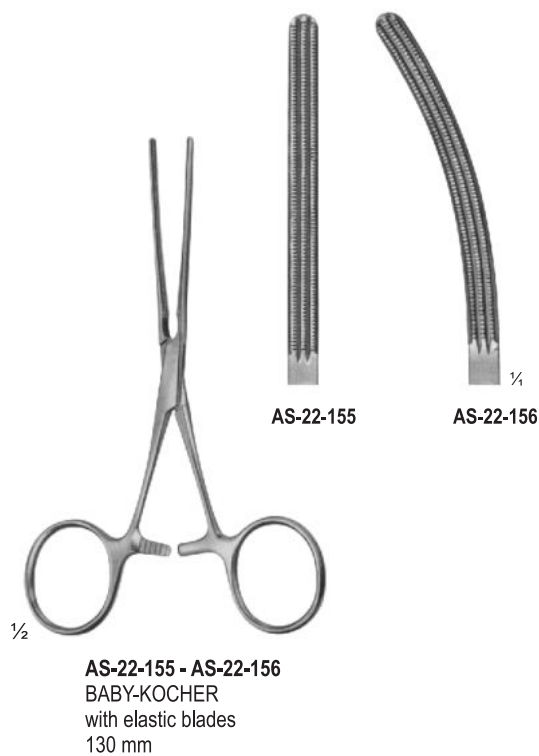
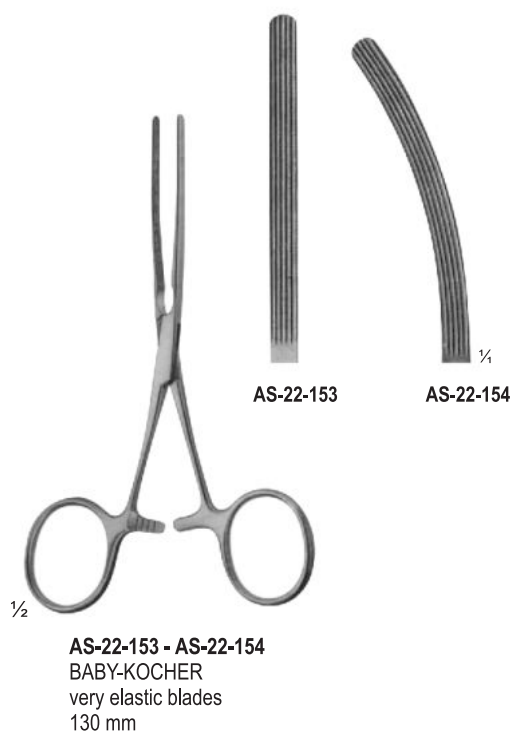

INTESTINAL CLAMPS, SOFT ELASTIC



ASAMAR
SURGICAL

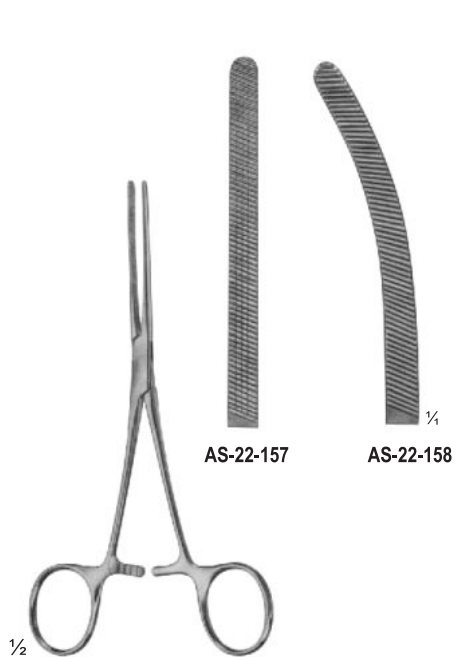

AS-22-157

AS-22-158

$\frac{1}{2}$
AS-22-157 - AS-22-158
DOYEN elastic
165 mm

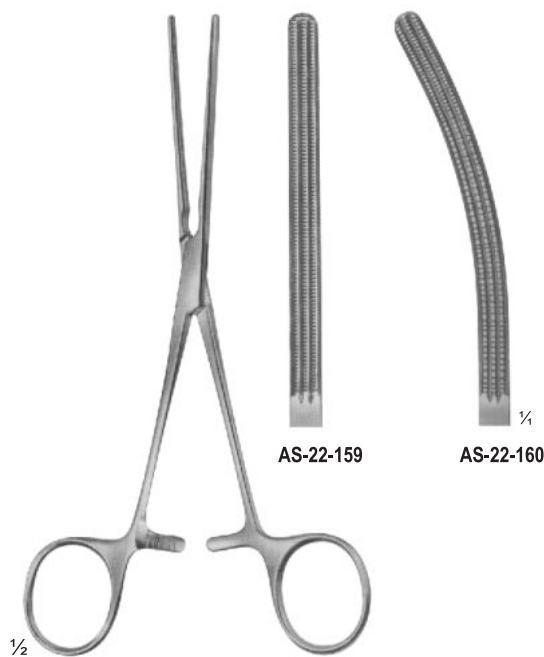

AS-22-159

AS-22-160

$\frac{1}{2}$
AS-22-159 - AS-22-160
DOYEN
with elastic blades
170 mm

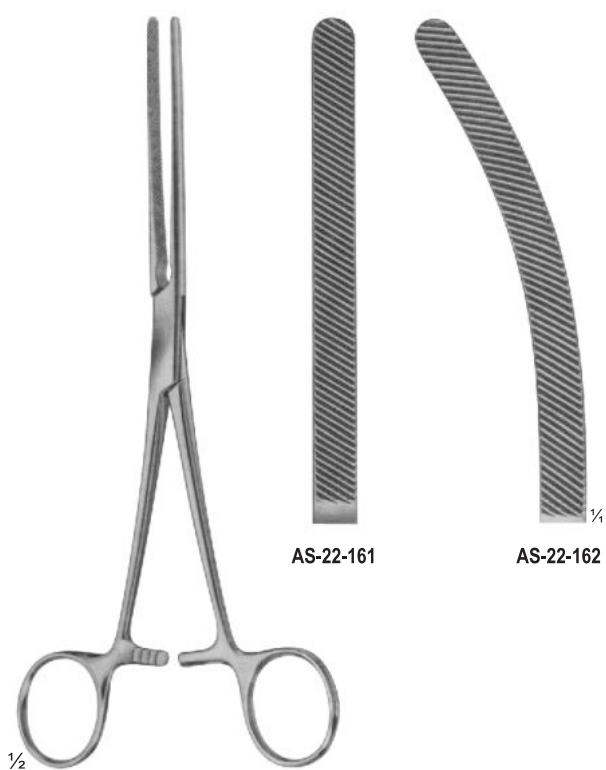

AS-22-161

AS-22-162

$\frac{1}{2}$
AS-22-161 - AS-22-162
HARTMANN
with elastic blades
200 mm



AS-22-163

AS-22-164

$\frac{1}{2}$
AS-22-163 - AS-22-164
HARTMANN
with elastic blades
200 mm

INTESTINAL CLAMPS, SOFT ELASTIC



ASAMAR
SURGICAL

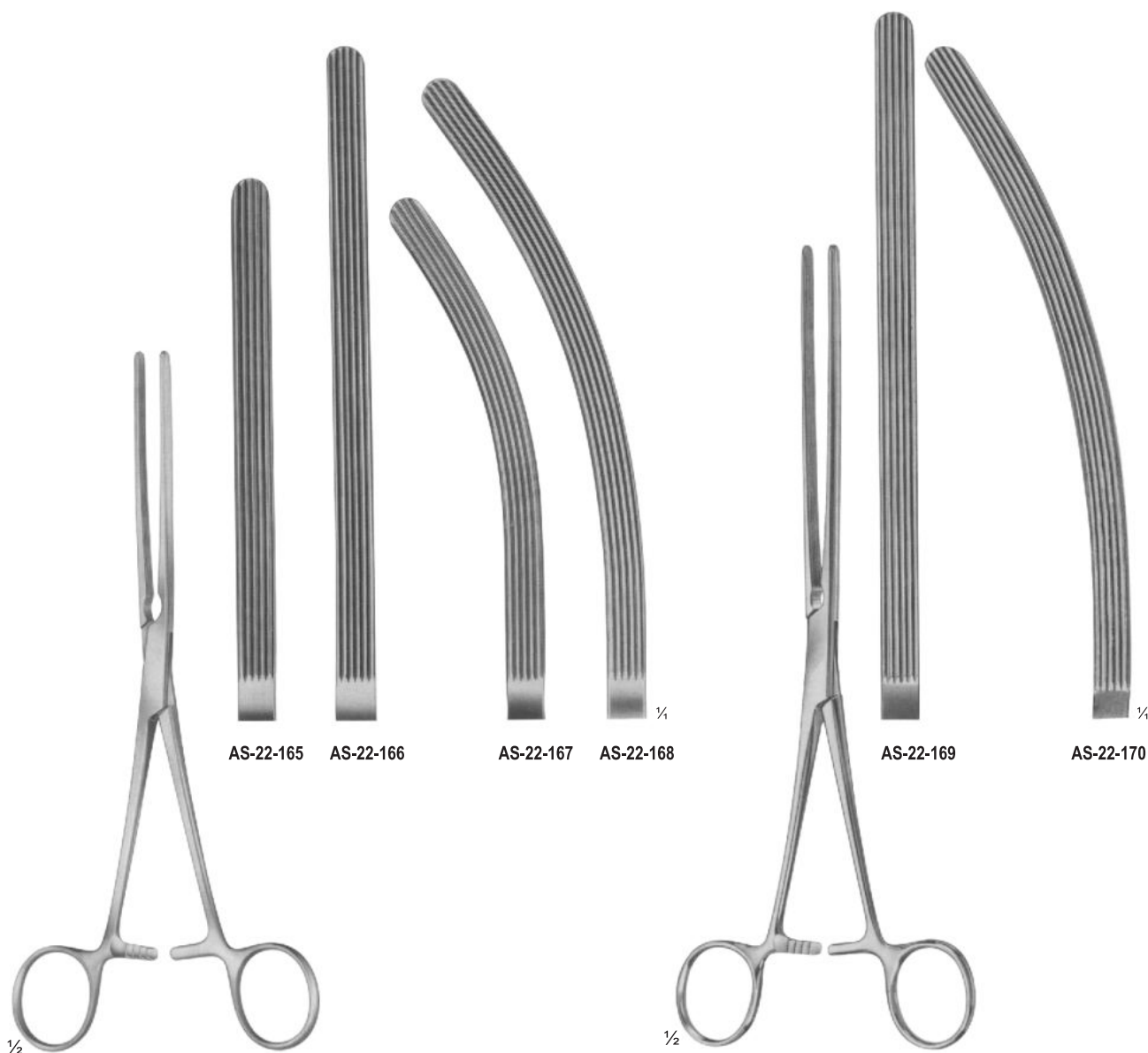

AS-22-165 - AS-22-166
KOCHER
with elastic blades
AS-22-167 210 mm
AS-22-168 230 mm

AS-22-169 - AS-22-170
DOYEN
with elastic blades
210 mm

INTESTINAL CLAMPS, SOFT ELASTIC



ASAMAR
SURGICAL



AS-22-171

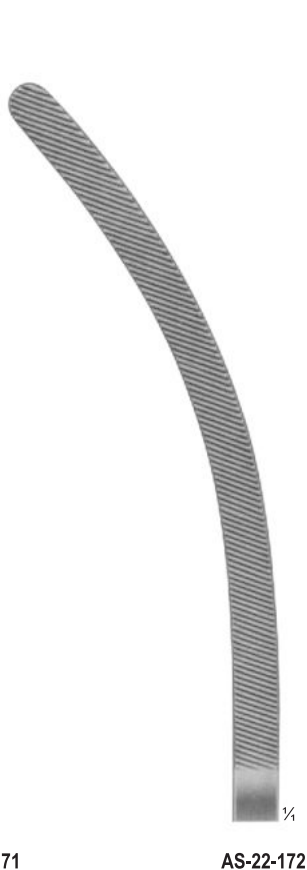

AS-22-172



AS-22-173



AS-22-174

AS-22-171 - AS-22-172
DOYEN
with elastic blades
235 mm

AS-22-173 - AS-22-174
DOYEN
with elastic blades
230 mm

INTESTINAL CLAMPS, SOFT ELASTIC



ASAMAR
SURGICAL

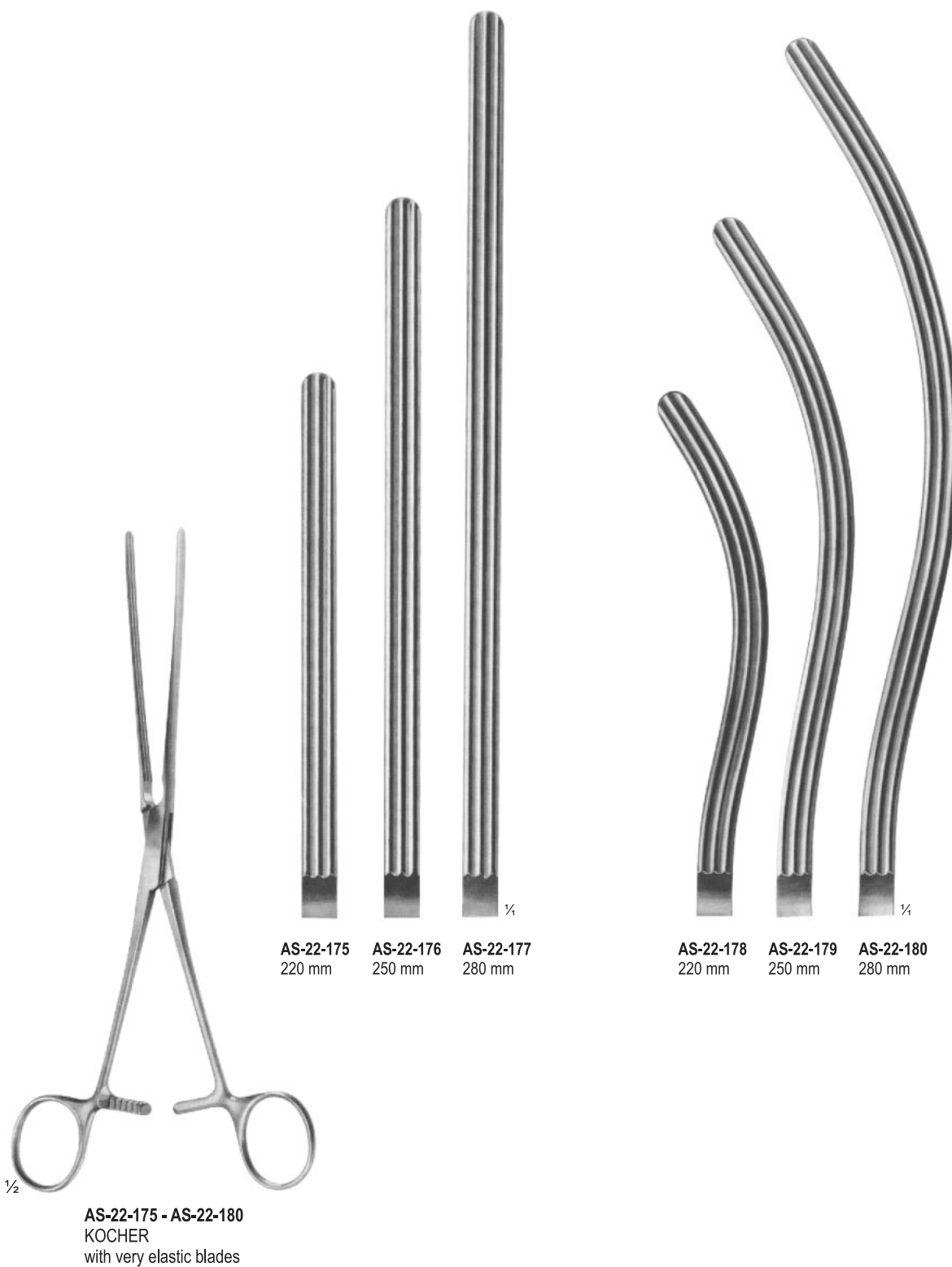

1/2

AS-22-175 - AS-22-180
KOCHER
with very elastic blades

AS-22-175 220 mm
AS-22-176 250 mm
AS-22-177 280 mm

AS-22-178 220 mm
AS-22-179 250 mm
AS-22-180 280 mm

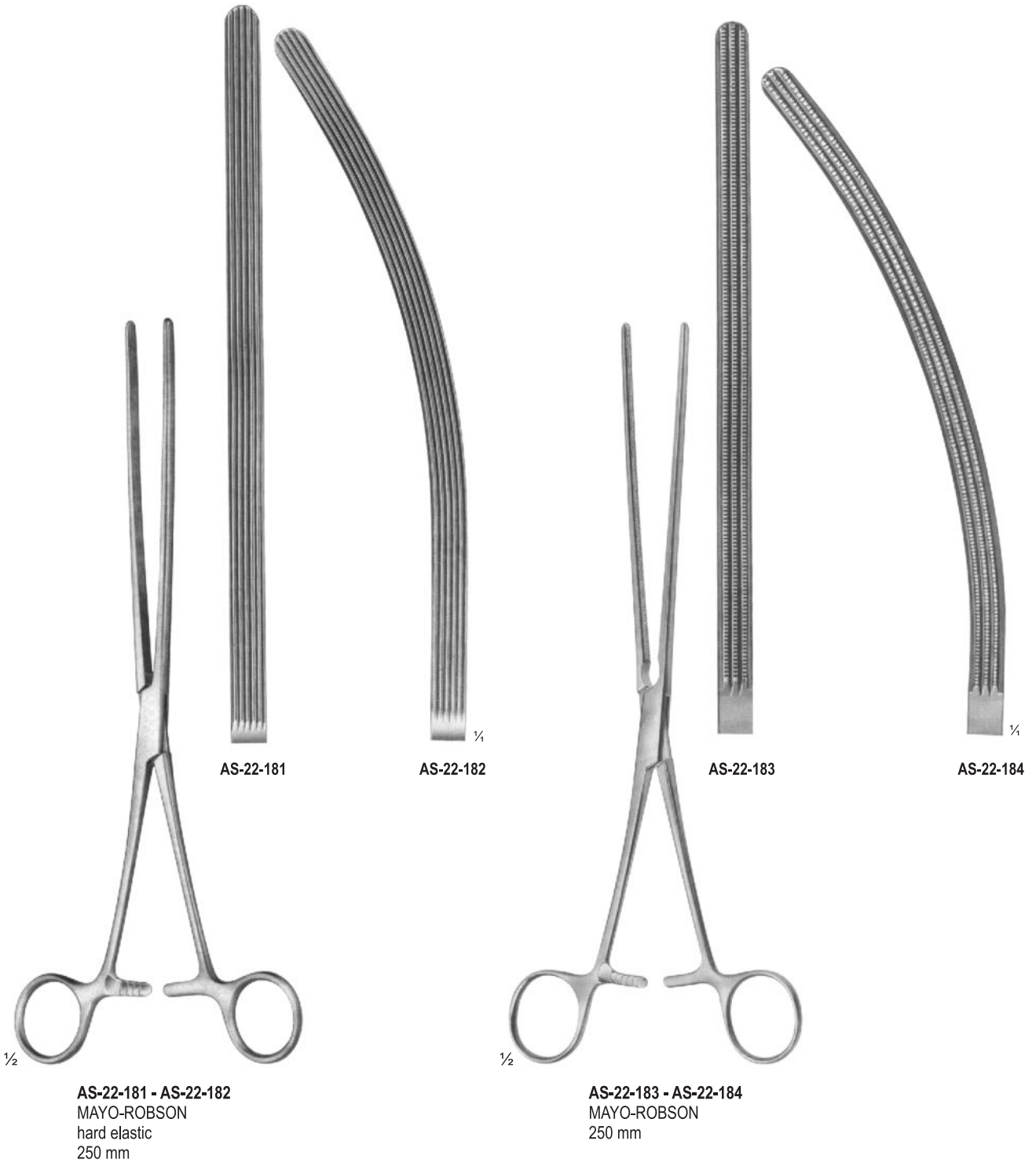



AS-22-187
KLEINSCHMIDT
Spur crushers and
Appendectomy
clamps 130 mm



AS-22-185

AS-22-185 - AS-22-186
SCUDDER
330 mm

1/4
AS-22-186

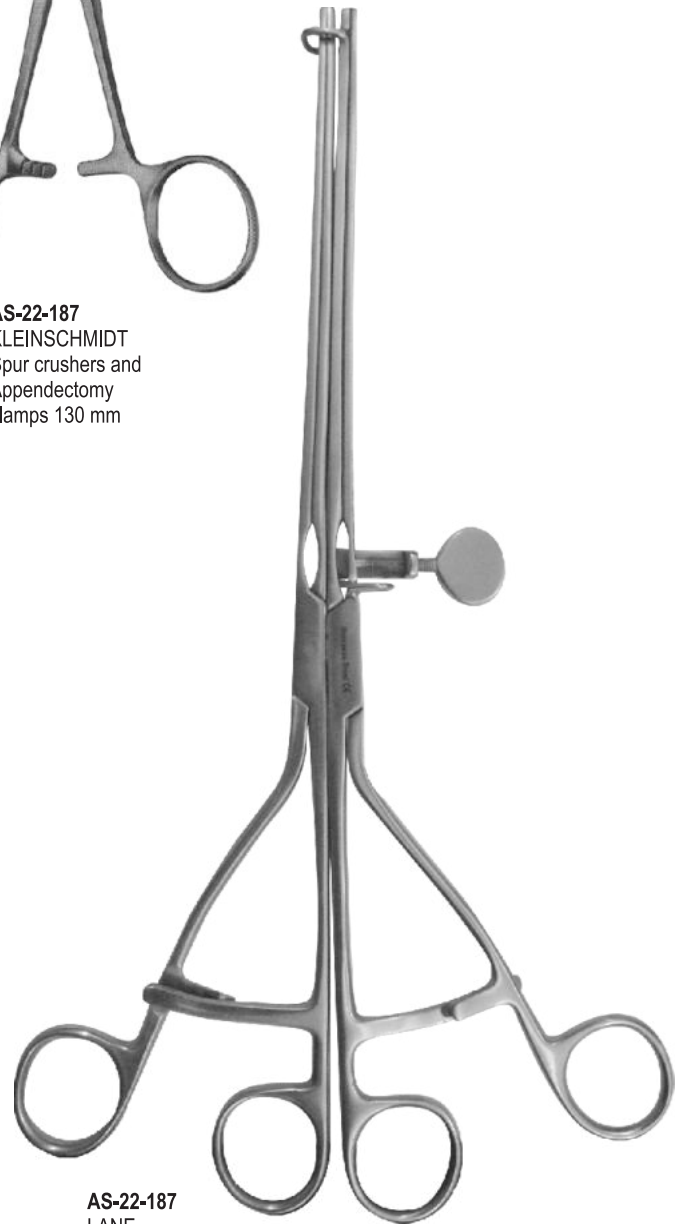

AS-22-187
LANE
310 mm,
12"



1/2
AS-22-188 PAYR
Intestinal clamp light
pattern, for children
180 mm

1/2
AS-22-189
PAYR
200 mm

1/2
AS-22-190
PAYR
275 mm

1/2

INTESTINAL CLAMPS, SOFT ELASTIC



ASAMAR
SURGICAL



BRUNNER
AS-22-192
230 mm

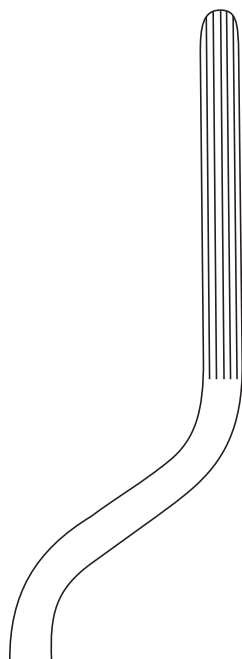

FEHLAND
AS-22-193
240 mm



Straight

KOCHER
with very elastic blades
AS-22-194 - AS-22-196
AS-22-194 22 cm
AS-22-195 25 cm **AS-22-196** 28 cm

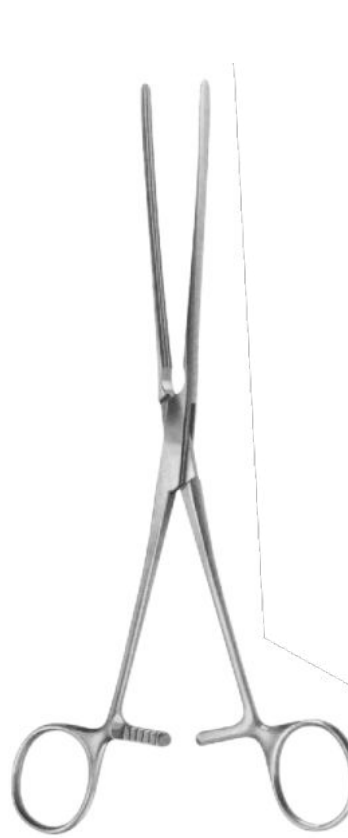

Curved

KOCHER
with very elastic blades
AS-22-197 - AS-22-199
AS-22-197 22 cm
AS-22-198 25 cm **AS-22-199** 28 cm

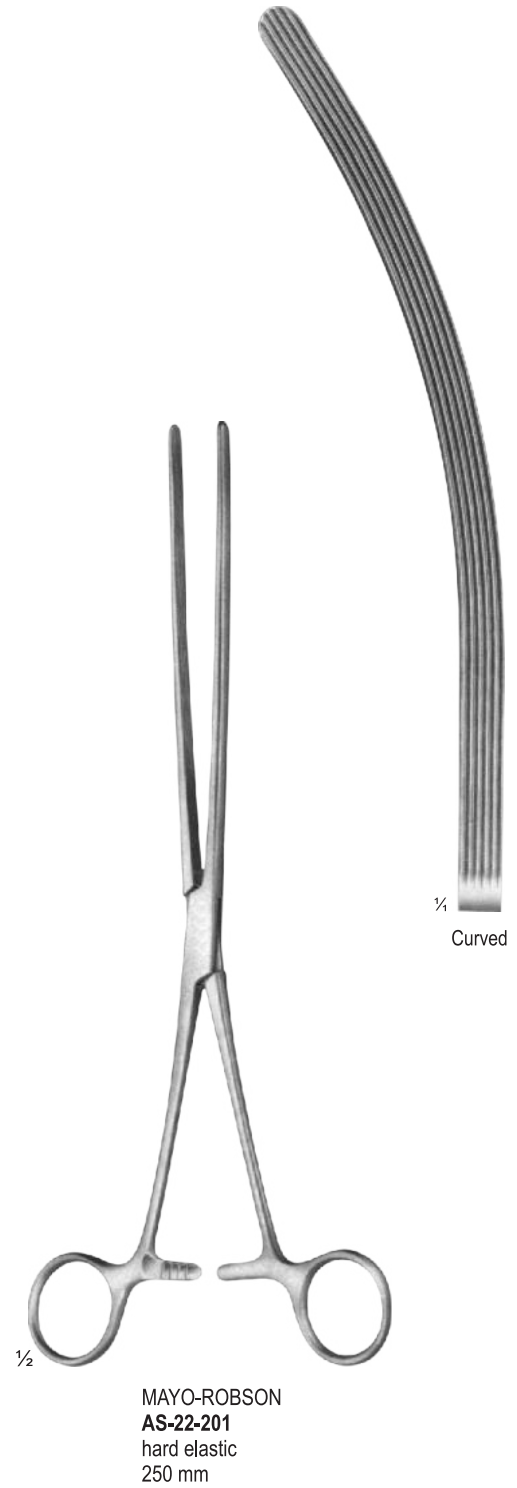

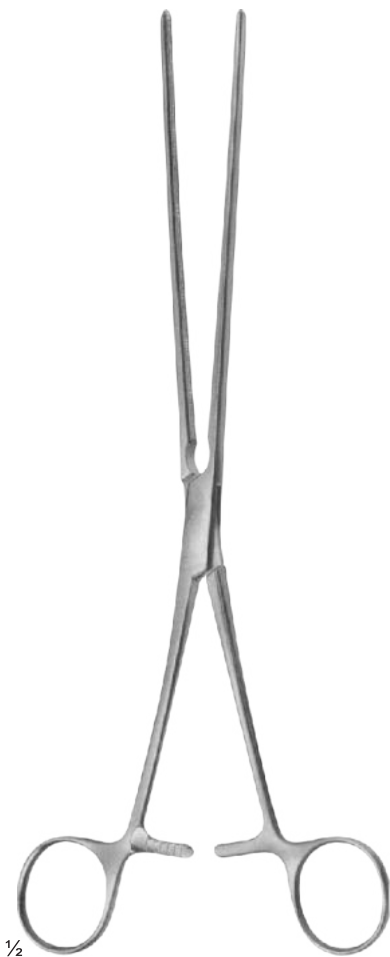

MAYO-ROBSON
AS-22-202
250 mm

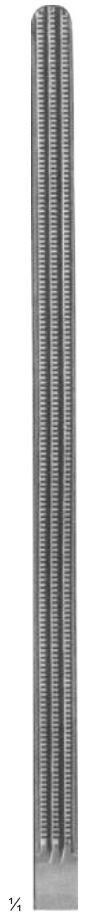

Straight

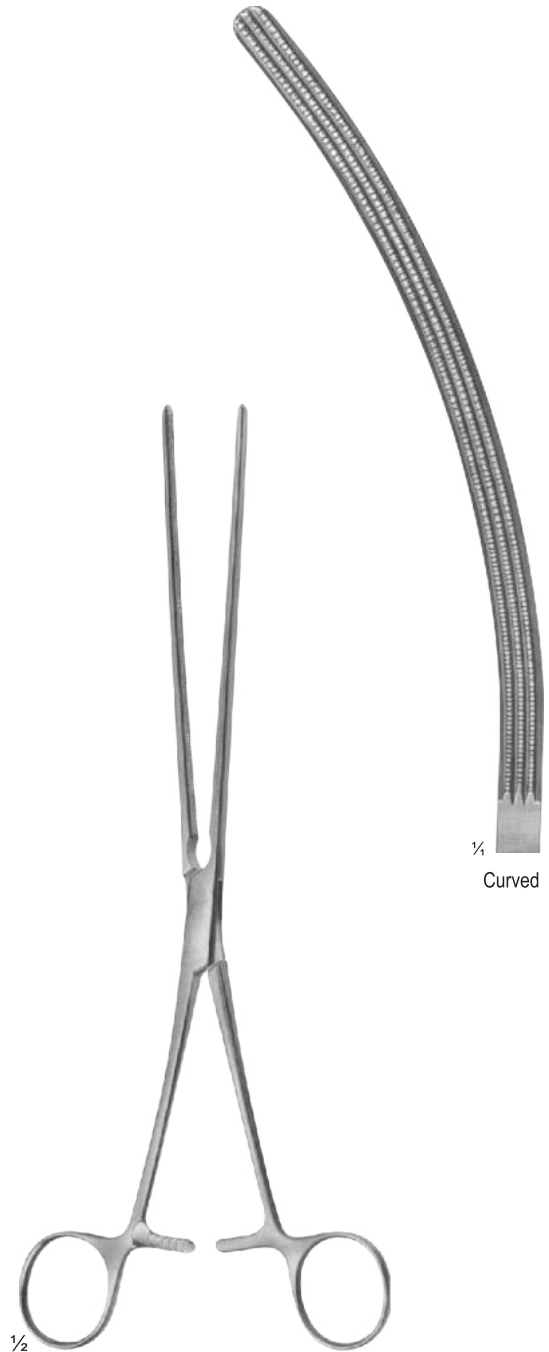

MAYO-ROBSON
AS-22-203
250 mm

Curved

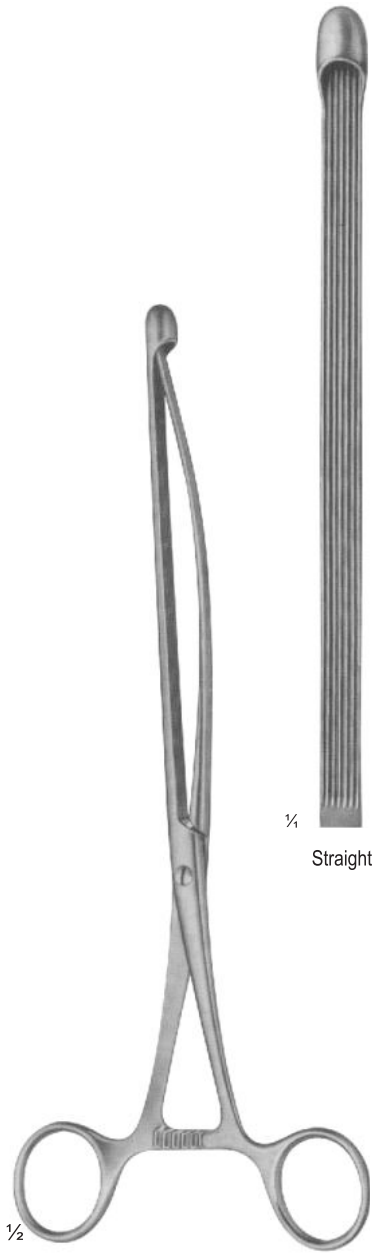

NUSSBAUM AS-22-204
with elastic
blades 250 mm



NUSSBAUM AS-22-205
with elastic
blades 250 mm

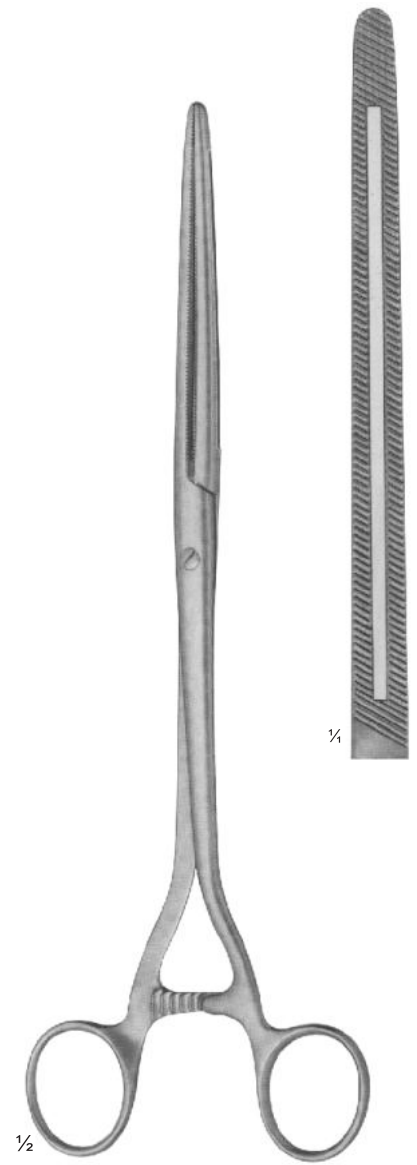

MOYNIHAN AS-22-206
280 mm



PARKER-KERR AS-22-207 anastomosis forceps for colon resection 180 mm

DICK pressure clamps **AS-22-208 - AS-22-211**
AS-22-208 180 mm
AS-22-209 255 mm
AS-22-210 265 mm
AS-22-211 275 mm

LLOYD-DAVIS AS-22-212
315 mm

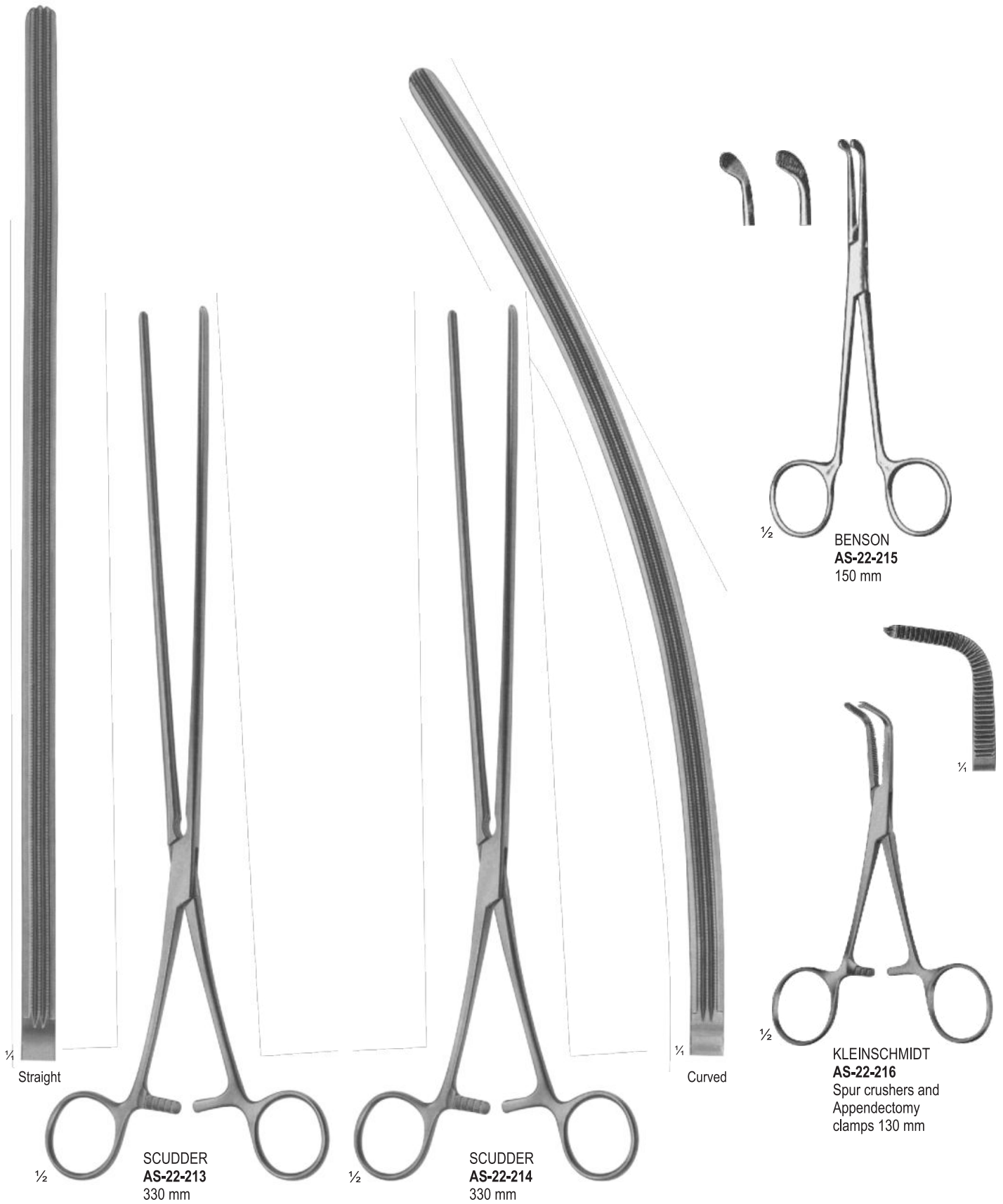

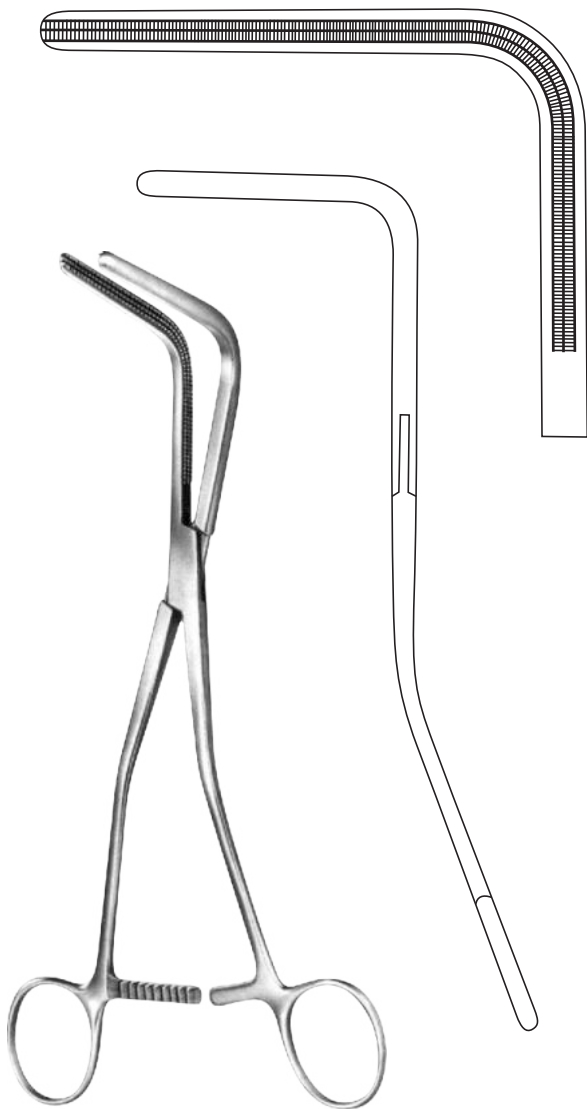

VEIDENHEIMER
AS-22-217
250 mm

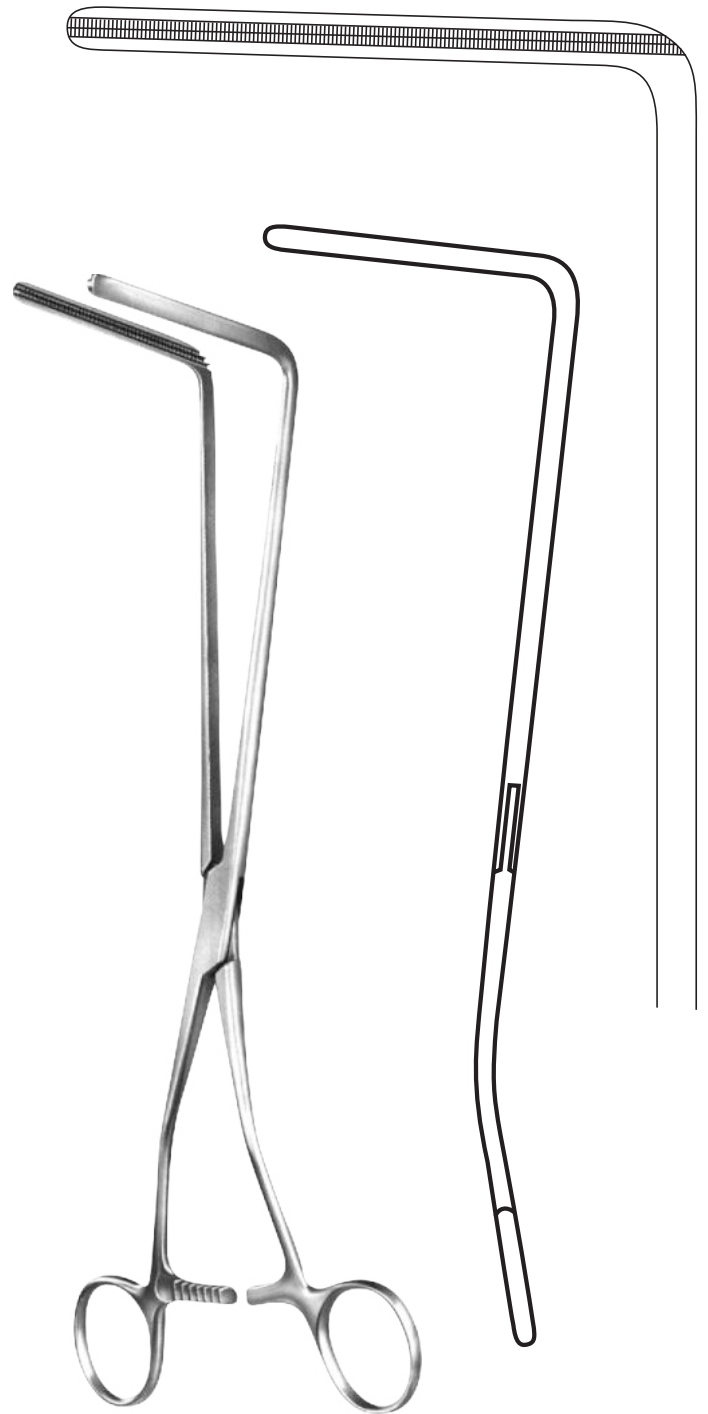

RESANO
AS-22-218
280 mm

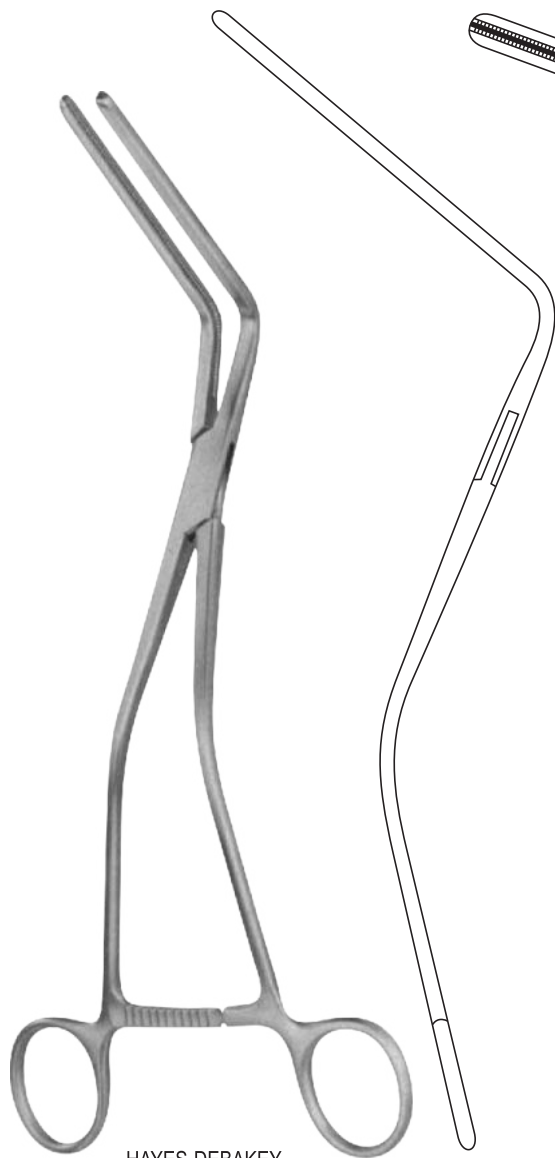

HAYES-DEBAKEY
AS-22-219 - AS-22-220

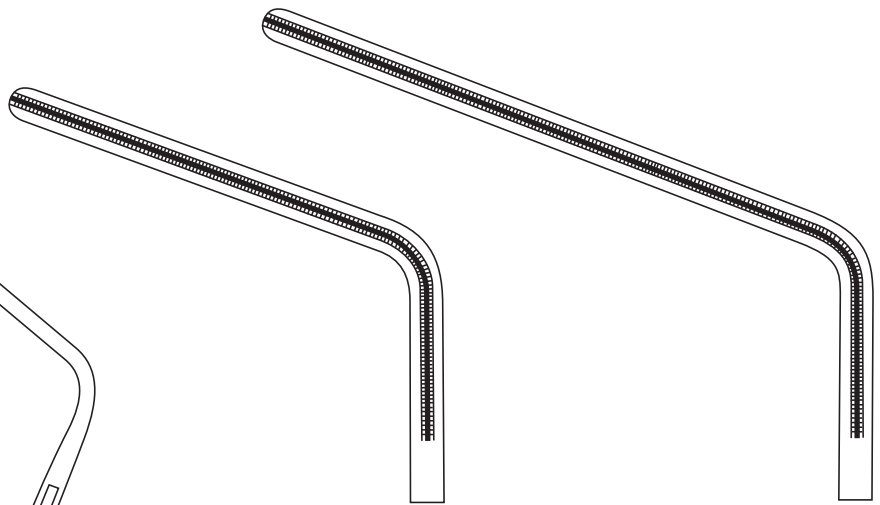

AS-22-219
260 mm
55 mm

AS-22-220
280 mm
85 mm



FEHLAND-DEBAKEY
AS-22-221
240 mm

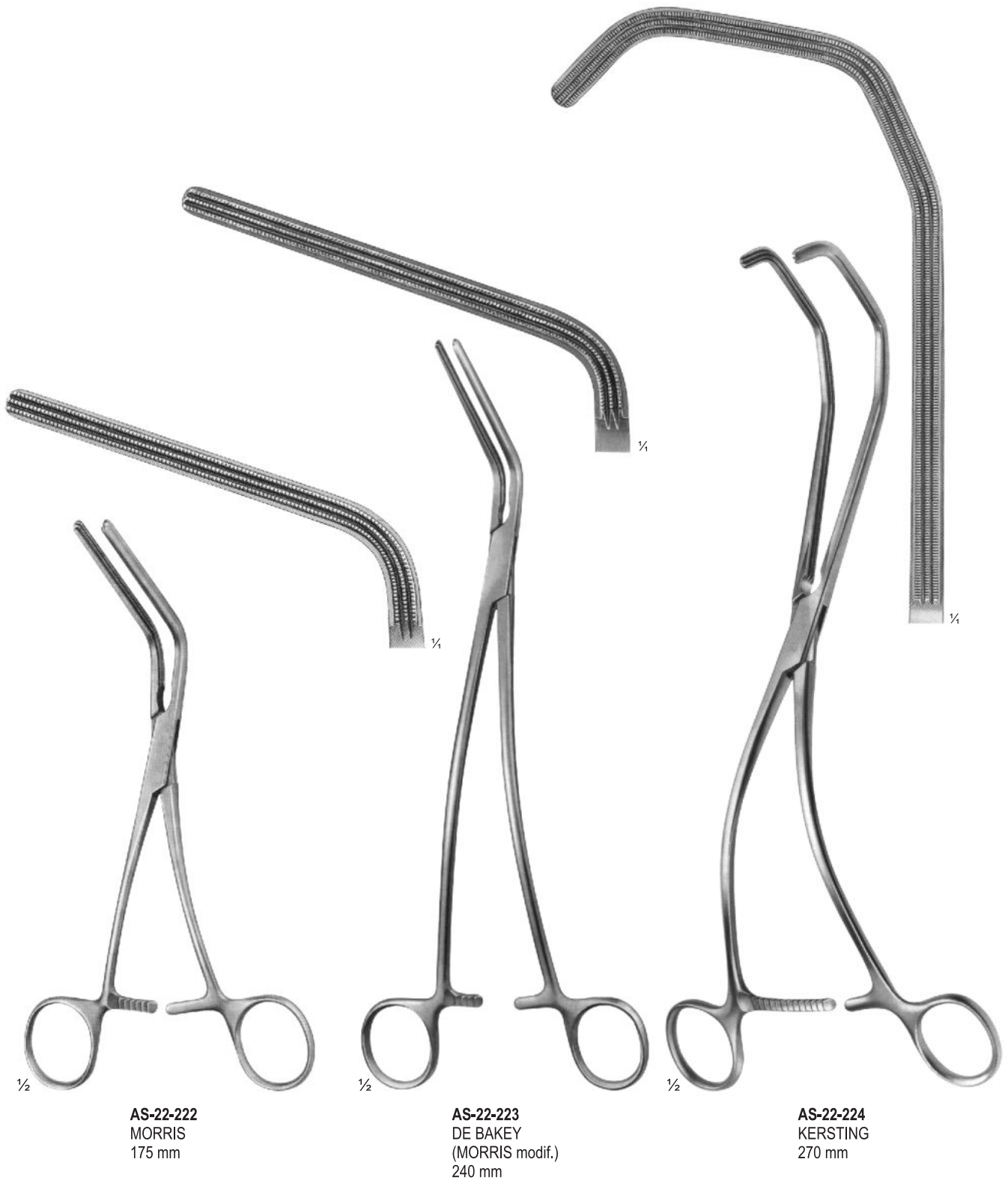

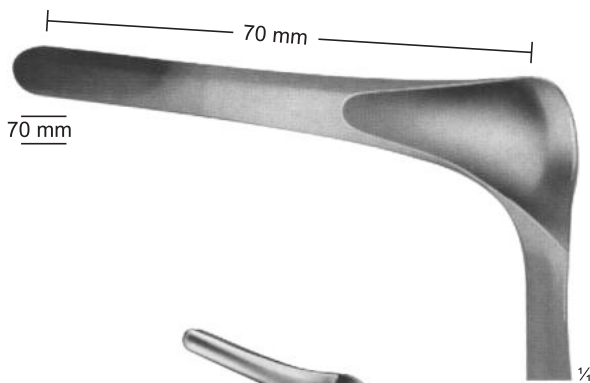

1/2

AS-22-225
KILLIAN
for
children
145 mm



1/2

AS-22-226 SIMS
160 mm



1/2

AS-22-227
SIMS
160 mm



CZERNY
AS-22-228
220 mm



ROSCHKE
AS-22-229
with fibre
optic

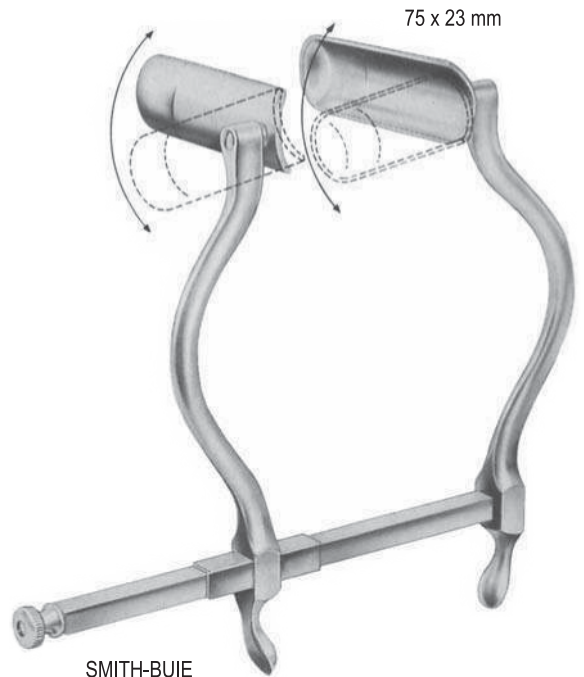

SMITH-BUIE
AS-22-230
150 mm



BARR
AS-22-231
170 mm

70 x 22 mm

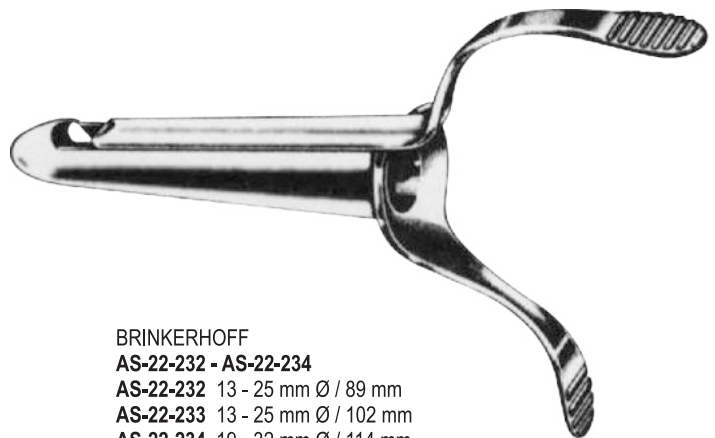

BRINKERHOFF
AS-22-232 - AS-22-234
AS-22-232 13 - 25 mm Ø / 89 mm
AS-22-233 13 - 25 mm Ø / 102 mm
AS-22-234 19 - 32 mm Ø / 114 mm



MCGIVNEY
AS-22-235
190 mm

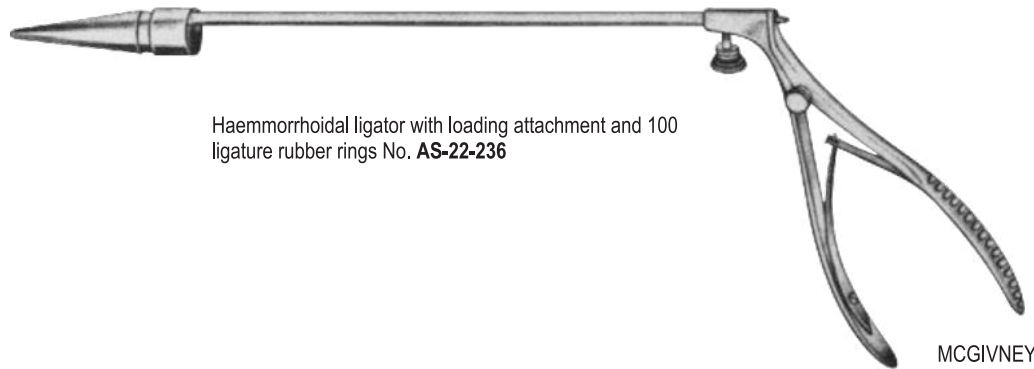

Haemorrhoidal ligator with loading attachment and 100 ligature rubber rings No. AS-22-236

MCGIVNEY
AS-22-236

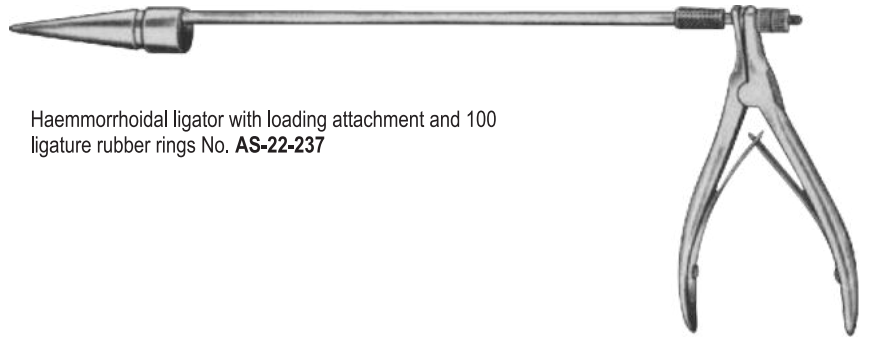

Haemorrhoidal ligator with loading attachment and 100 ligature rubber rings No. AS-22-237

FORD-DIXON
AS-22-237

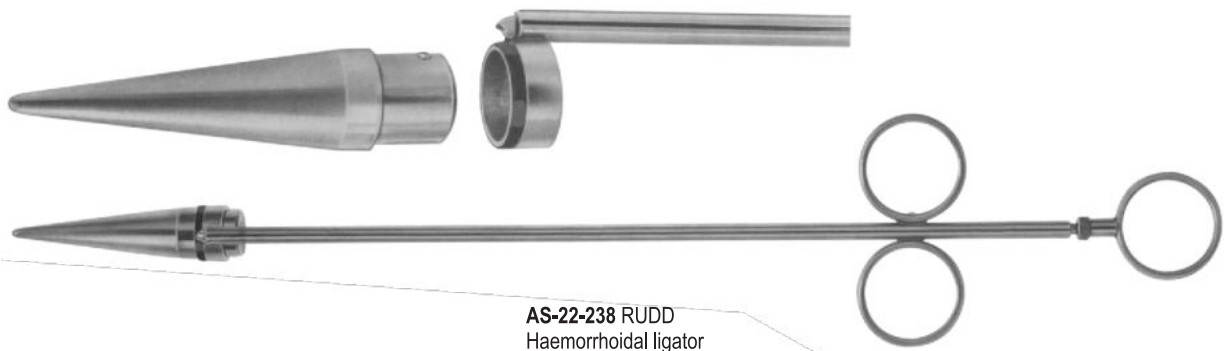

AS-22-238 RUDD
Haemorrhoidal ligator
with loading
attachment and 100
ligature rubber rings
315 mm



RUDD
AS-22-239
100
pieces

BIOPSY FORCEPS & SWAB HOLDERS



ASAMAR
SURGICAL

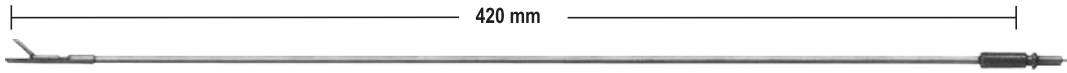

AS-22-240 - AS-22-243
Handle for 265 - 266 - 267 - 268

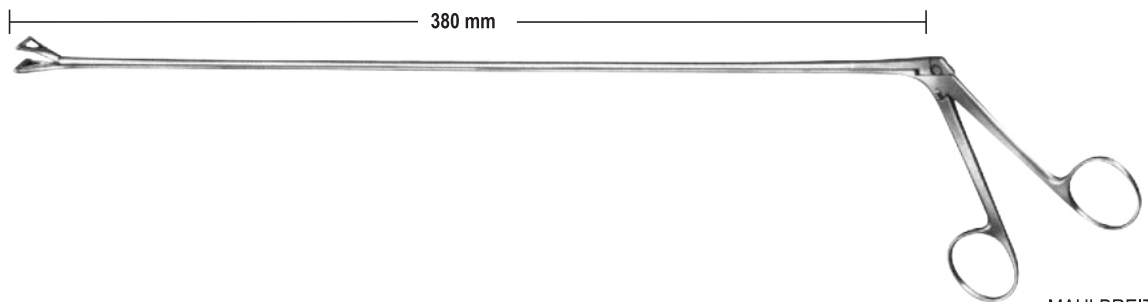

MAULBREITE
JAW WIDTH
AS-22-244
380 mm
15 mm



BUIE AS-22-245
160 mm



PRATT AS-22-246 - AS-22-248
215 mm



Fig. 1 AS-22-246

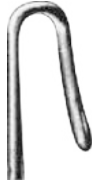

Fig. 2 AS-22-247

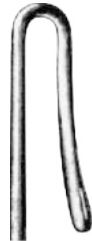
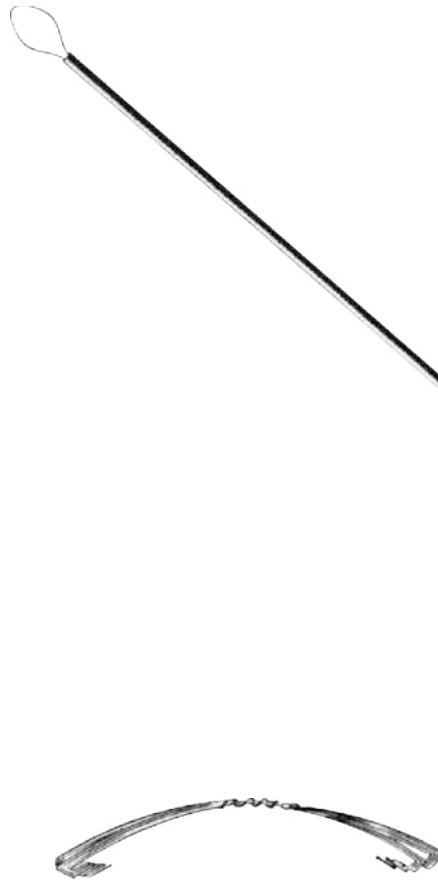

Fig. 3 AS-22-248



AS-22-249
12 pieces / 12 piezas



WESTON AS-22-250
300 mm



NORWOOD AS-22-251
300 mm



BUIE AS-22-252
300 mm



AS-22-253
380 mm

AS-22-254
380 mm



KATZENSTEIN AS-22-255
90 mm

RECTAL SPECULA

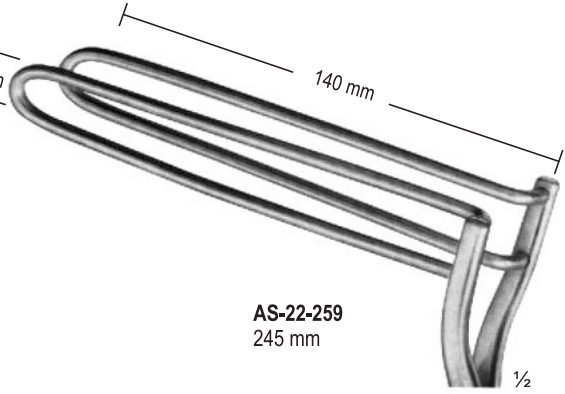
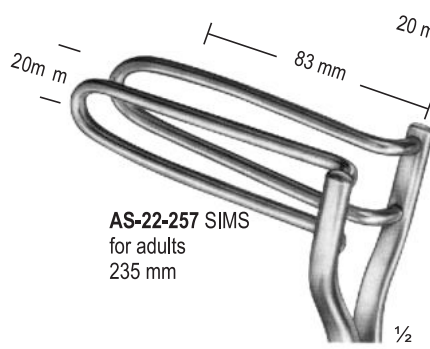
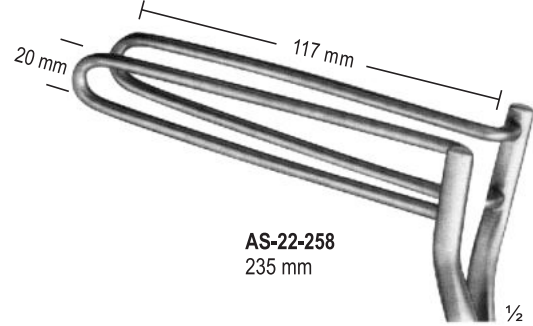
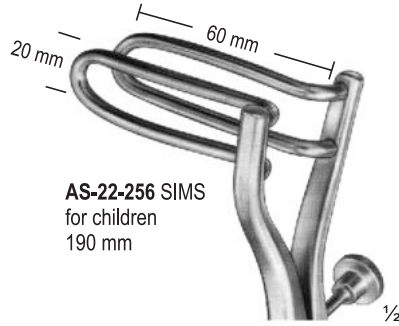

AS-22-256 - AS-22-259

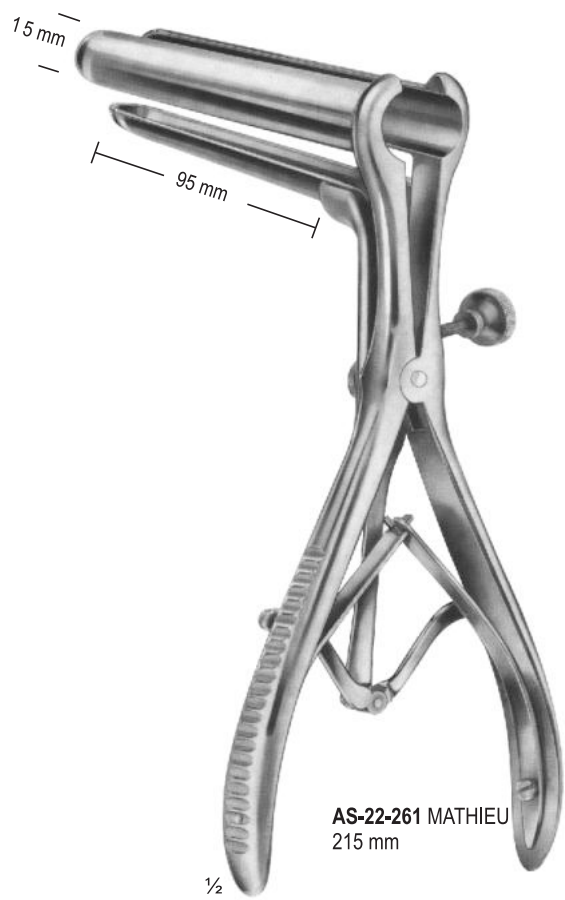

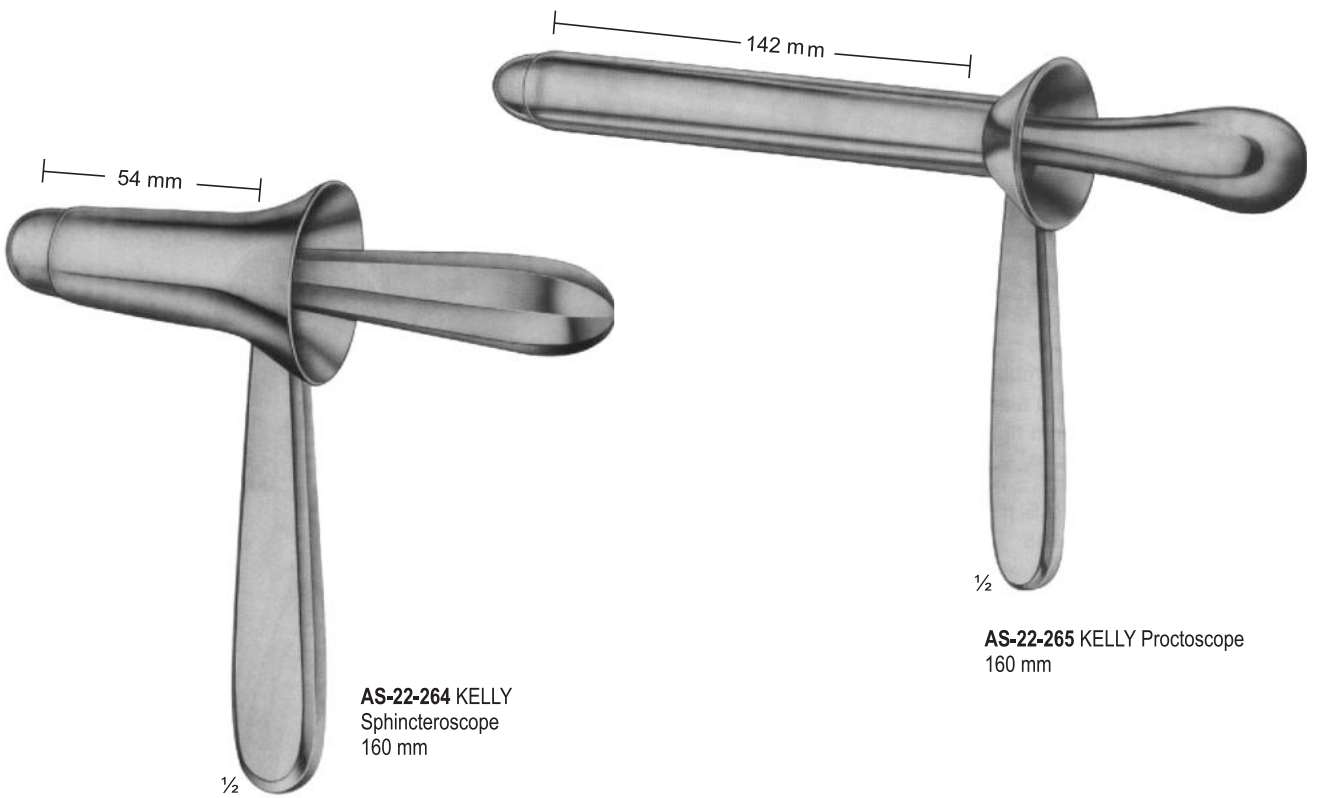

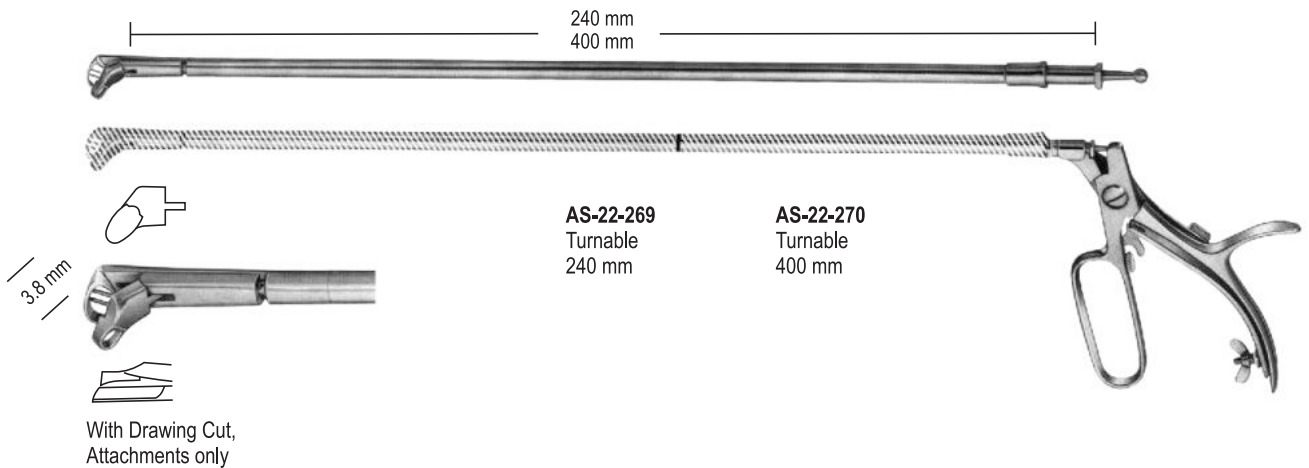
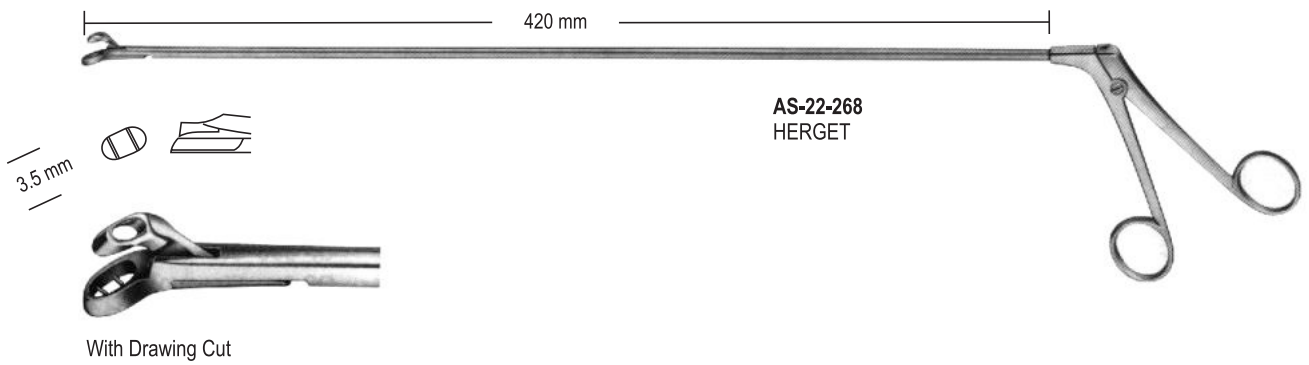
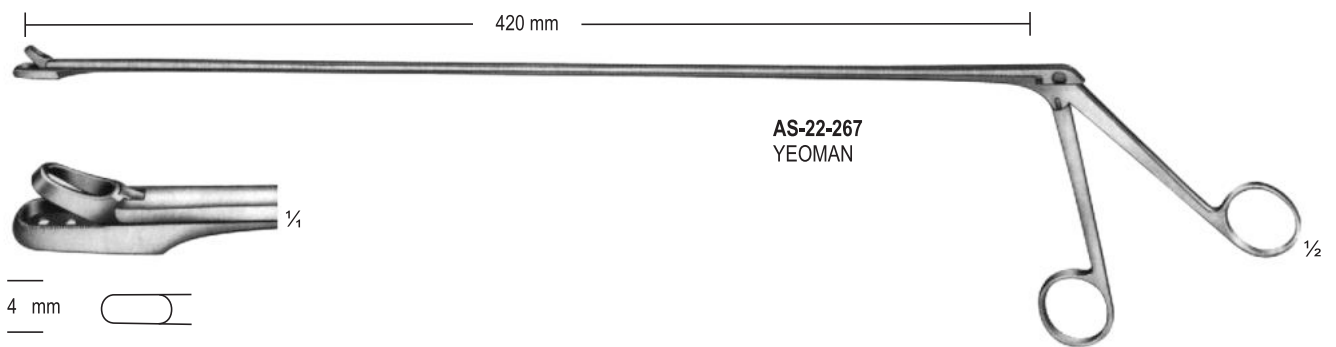
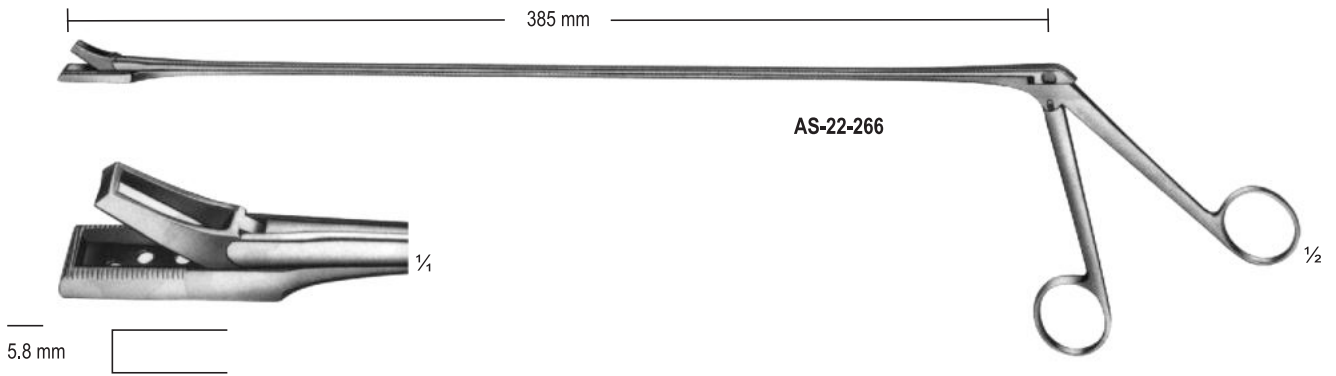



AS-22-271
LOWER
180 mm



AS-22-272
LAHEY (SWEET)
190 mm



AS-22-273
LAHEY
220 mm



AS-22-274 DESJARDINS
Gall duct and cystic
forceps 210 mm

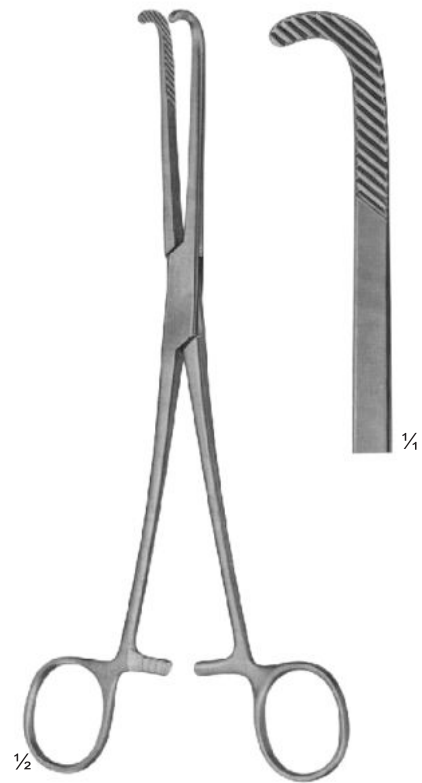

AS-22-275 NISSEN
Gall duct and cystic
forceps 215 mm

GALL DUCT FORCEPS & CHOLEDOCHUS FORCEPS



ASAMAR
SURGICAL

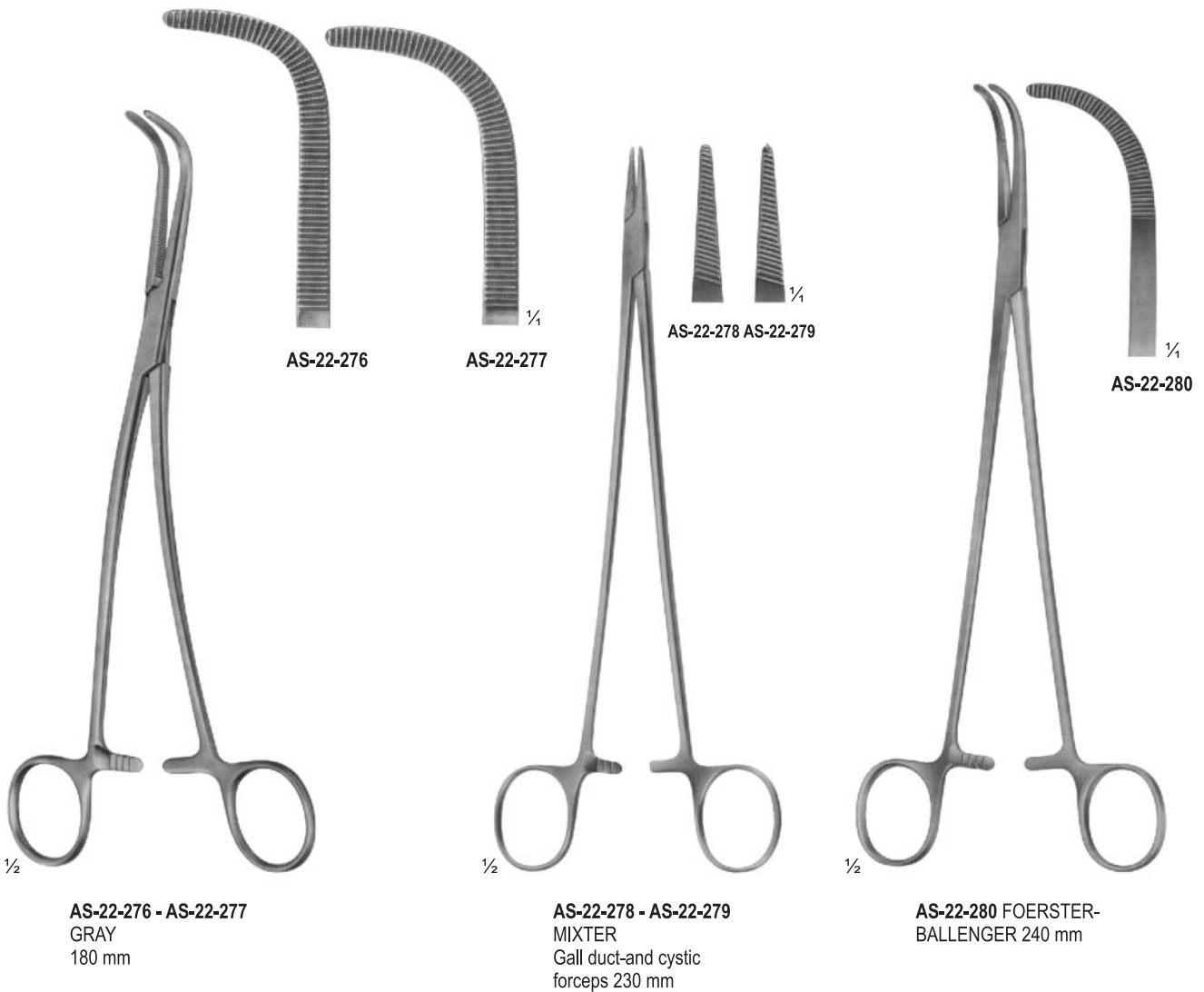

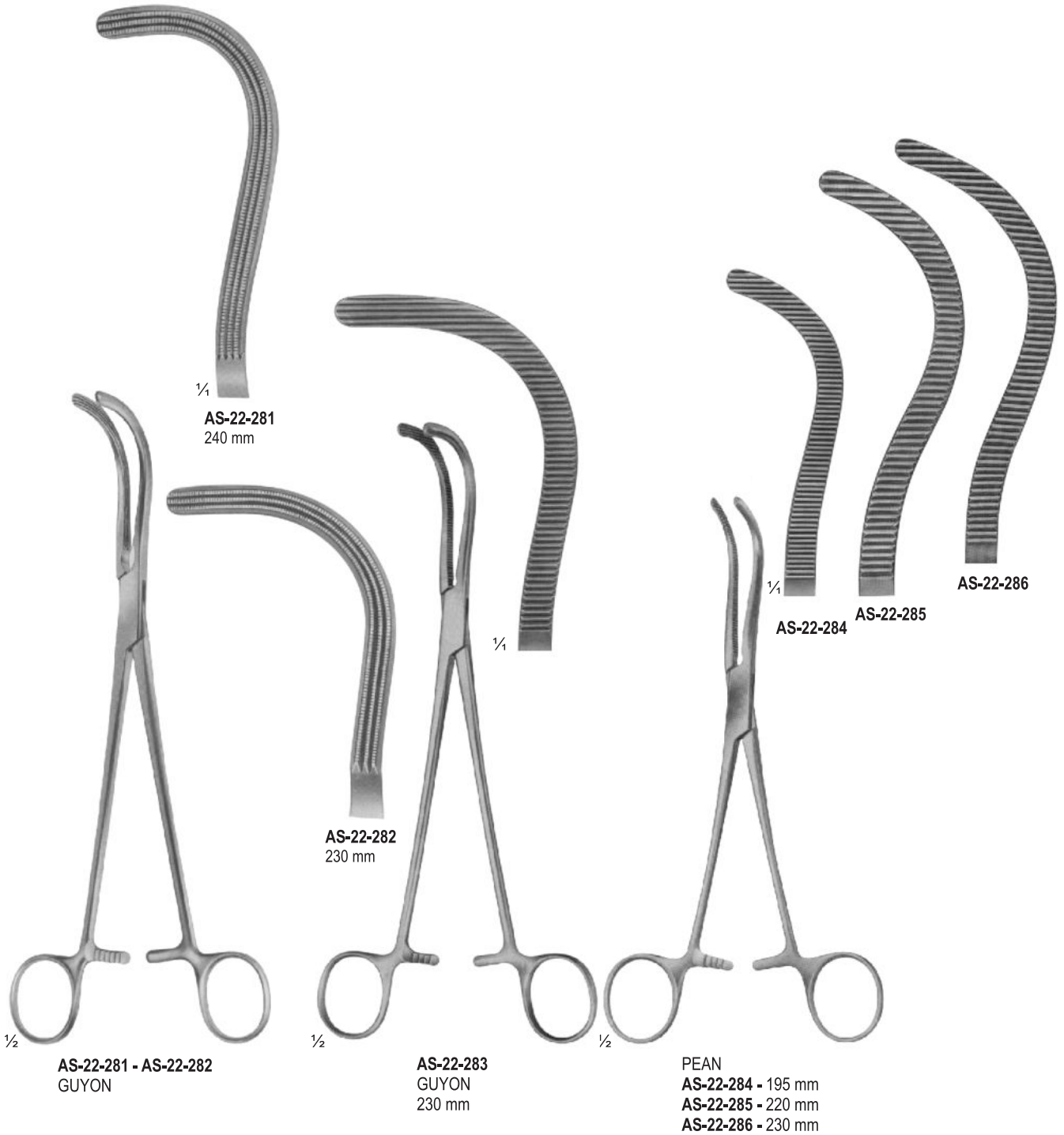

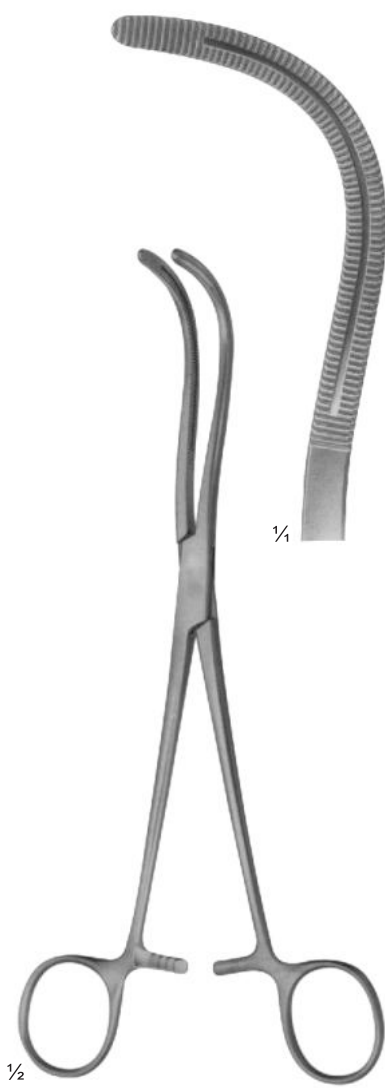

AS-22-287
STILLE
220 mm

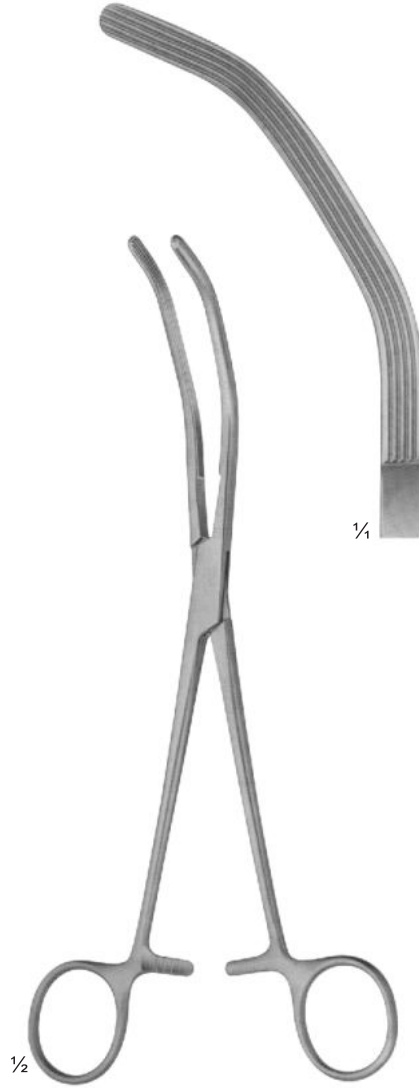

AS-22-288
HERRICK
225 mm

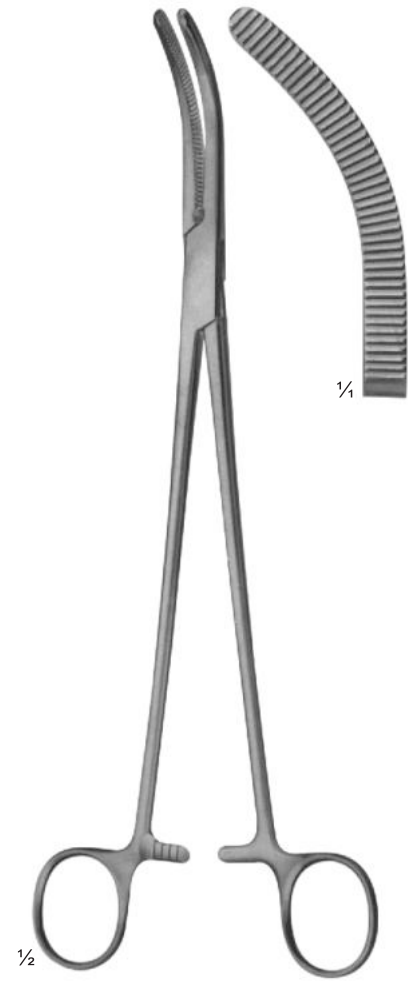

AS-22-289
WERTHEIM
225 mm



ASAMAR
SURGICAL 

PAGE
535-551
MICRO INSTRUMENTS

MICRO SCISSORS "SPRING TYPE" FLAT HANDLES

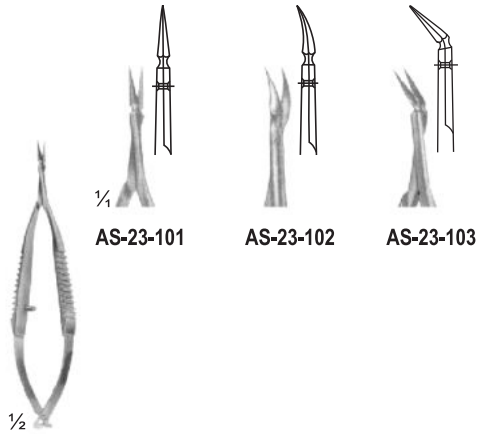

AS-23-101 - AS-23-103
VANNAS
85 mm



AS-23-104 - AS-23-105
CASTROVIEJO
95 mm

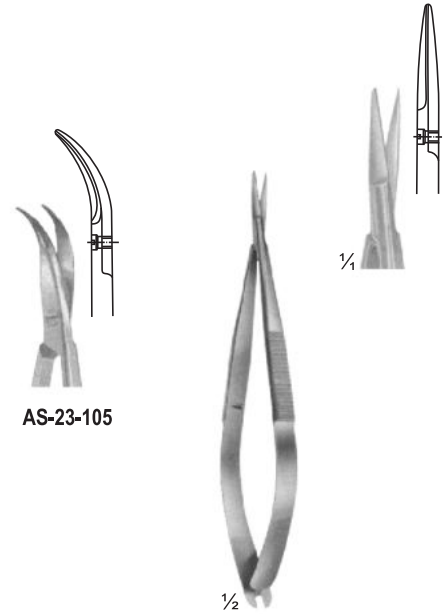

AS-23-106
NOYES 125
mm

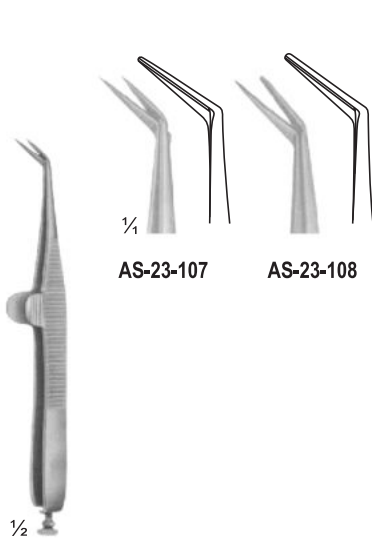

AS-23-107 - AS-23-108
WECKER
Eye Scissor
110 mm

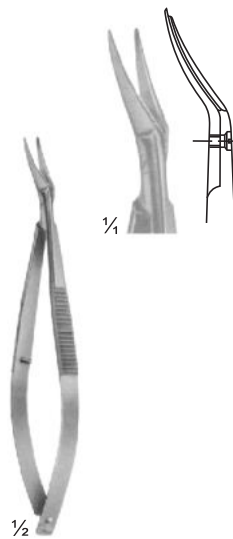

AS-23-109
CASTROVIEJO
Eye Scissor
115 mm

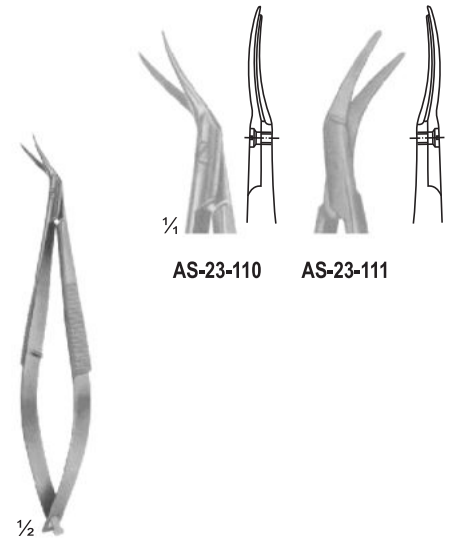

AS-23-110 - AS-23-111
CASTROVIEJO
Eye Scissor
110 mm

MICRO SCISSORS "SPRING TYPE" FLAT HANDLES

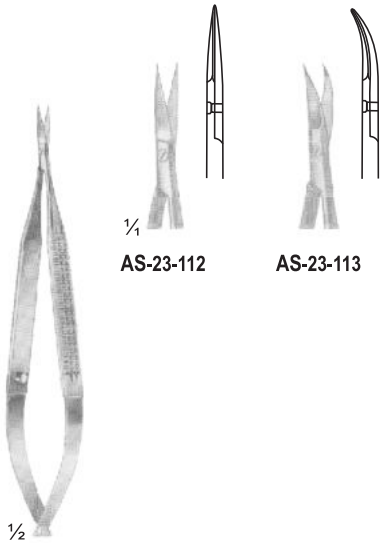

AS-23-112 - AS-23-113
120 mm

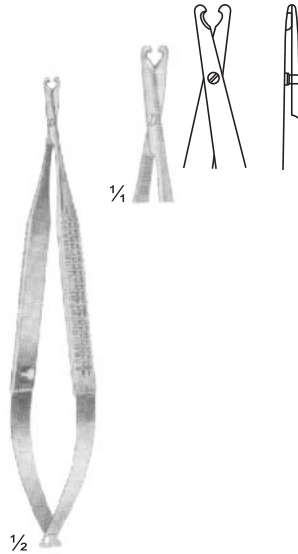

AS-23-114
BIEMER
Vein Scissor
130 mm

AS-23-115
160 mm

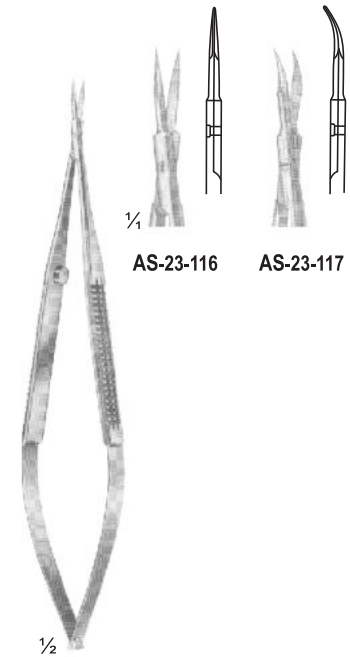

AS-23-116 - AS-23-117
VANNAS
160 mm

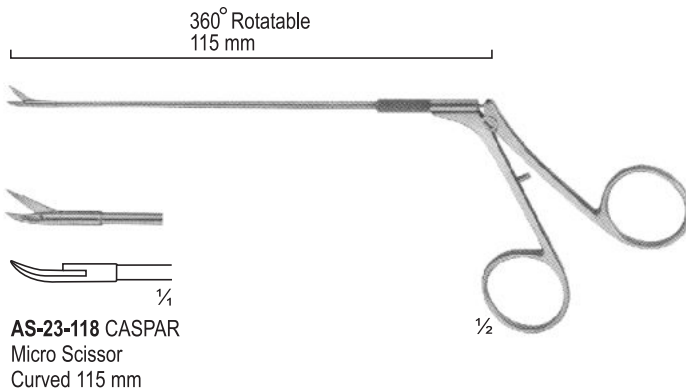

AS-23-118 CASPAR
Micro Scissor
Curved 115 mm

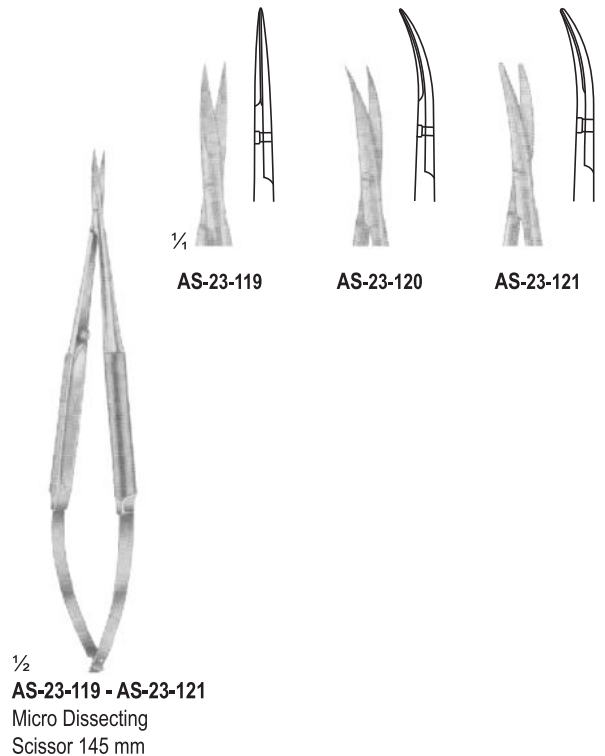

AS-23-119 - AS-23-121
Micro Dissecting
Scissor 145 mm

**MICRO SCISSORS "SPRING TYPE"
BAYONET SHAPE**

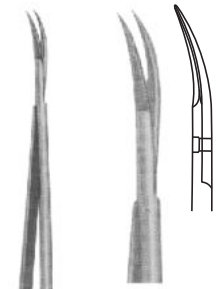

1/2
AS-23-122
YASARGIL
245 mm



1/4
AS-23-123

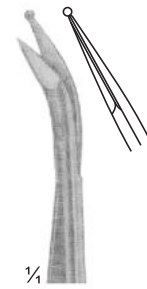

1/4
AS-23-124



1/2
AS-23-123 - AS-23-124
Laterally Angled
200 mm

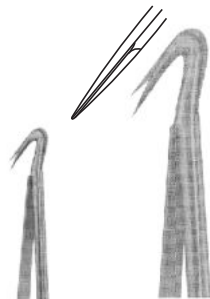

1/2
AS-23-125
Laterally Angled
190 mm

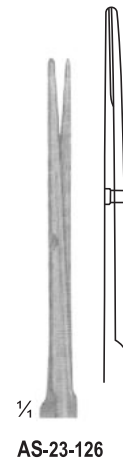

1/4
AS-23-126

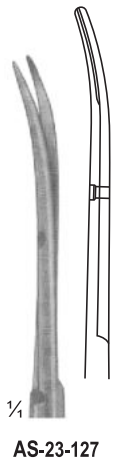

1/4
AS-23-127



1/2
AS-23-126 - AS-23-127
YASARGIL
225 mm

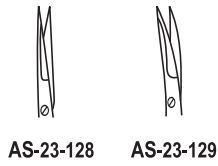

AS-23-128 AS-23-129

AS-23-128 - AS-23-129
CASTROVIEJO
Spring Scissors
15, 18 cm

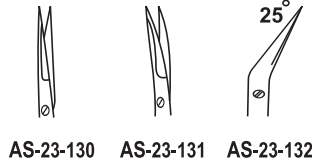

AS-23-130 AS-23-131 AS-23-132

AS-23-130 - AS-23-132
STREAMLINE
Micro Coronary
Scissors
15, 18, 21, 23 cm

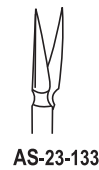

AS-23-133

AS-23-133
STREAMLINE
Spring
Scissors 23 cm



AS-23-134 AS-23-135

AS-23-134 - AS-23-135
STREAMLINE
Spring Scissors
23 cm



AS-23-136 AS-23-137

AS-23-136 - AS-23-137
TOLEDO
Spring Scissors
16.5 cm

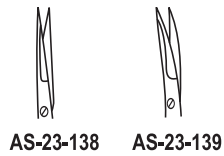

AS-23-138 AS-23-139

AS-23-138 - AS-23-139
BARRAQUER
Spring Scissors
12, 15, 18 cm

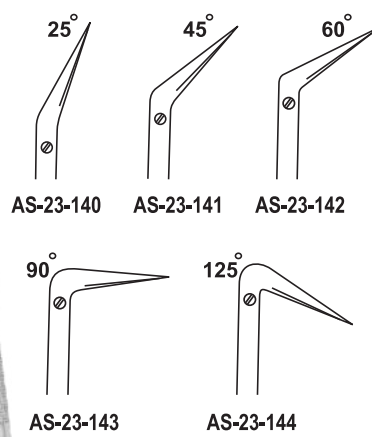

AS-23-140 AS-23-141 AS-23-142
AS-23-143 AS-23-144

AS-23-140 - AS-23-144
BARRAQUER
Spring Scissors
18 cm

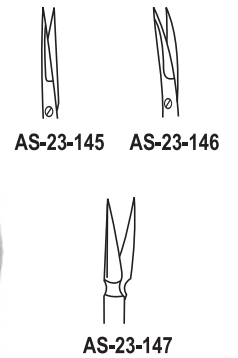

AS-23-145 AS-23-146
AS-23-147

AS-23-145 - AS-23-147
BARRAQUER
Spring Scissors Bayonet
22 cm

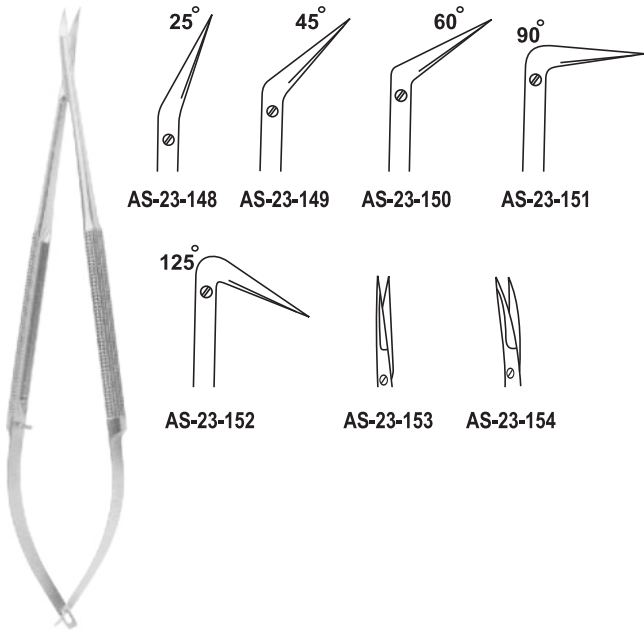

AS-23-148 AS-23-149 AS-23-150 AS-23-151

AS-23-152 AS-23-153 AS-23-154



AS-23-155 ONG-TREUMER
Capsulotomy
Scissors 8 cm



AS-23-156 VANNAS-TUBINGEN After-Cataract Scissors
8 cm
8 mm



AS-23-157 WESTCOTT
Tenotomy
Scissors 11 cm

AS-23-148 - AS-23-154
STREAMLINE
Spring Scissors
18, 21 cm



AS-23-158 WESTCOTT
Micro-Tenotomy
Scissors
10.5 cm



AS-23-159
Micro Spring
Scissors
10.5 cm
12 mm



AS-23-160 CASTROVIEJO
Corneal
Scissors 10.5
cm



AS-23-161 TROUTMAN
Corneal
Scissors 10 cm



AS-23-162
BONN
Eye
Scissors 9
cm



AS-23-163
Eye
Scissors
10.6 cm

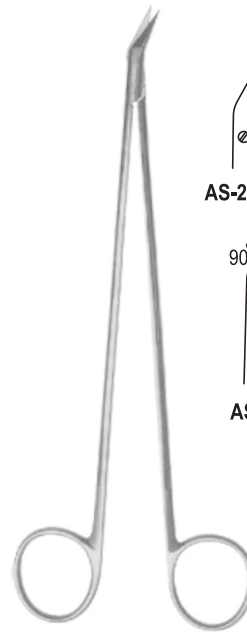

AS-23-164 - AS-23-168
HEGEMANN
Ring Scissors
18 cm

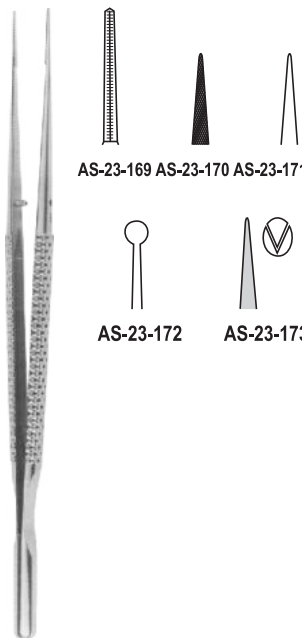
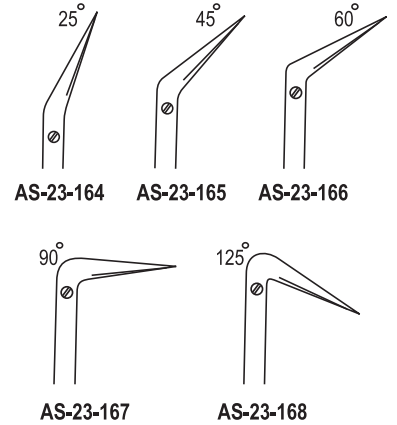

AS-23-169 - AS-23-173
TOLEDO
Forceps Heavy
18, 21 cm

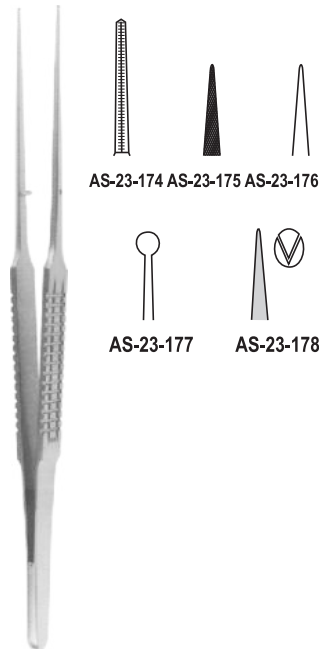

AS-23-174 - AS-23-178
Forceps
15, 18 cm

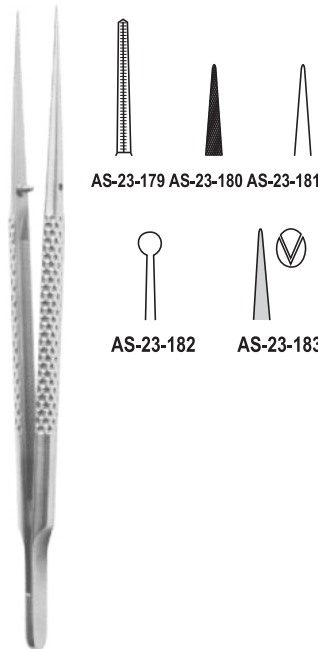

AS-23-179 - AS-23-183
TOLEDO Forceps
18, 21 cm

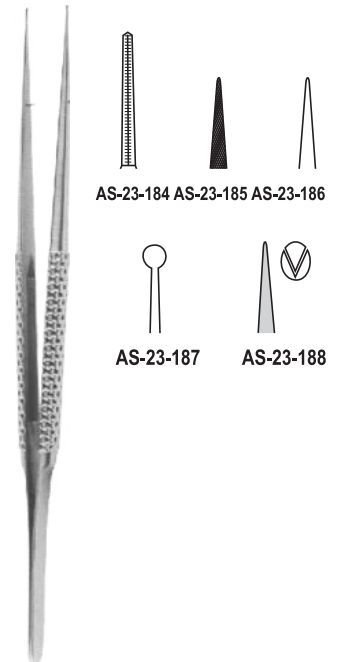

AS-23-184 - AS-23-188
15, 18, 21 cm

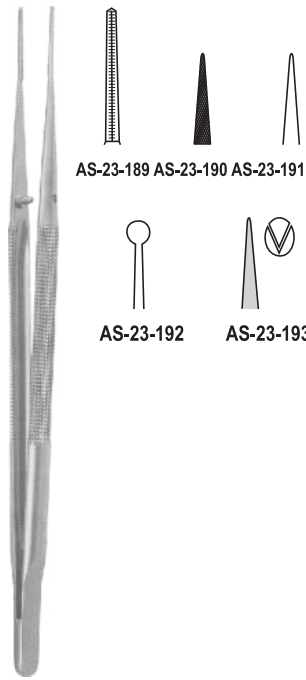

AS-23-189 AS-23-190 AS-23-191

AS-23-192 AS-23-193

AS-23-189 - AS-23-193
Forceps
15, 18, 21 cm

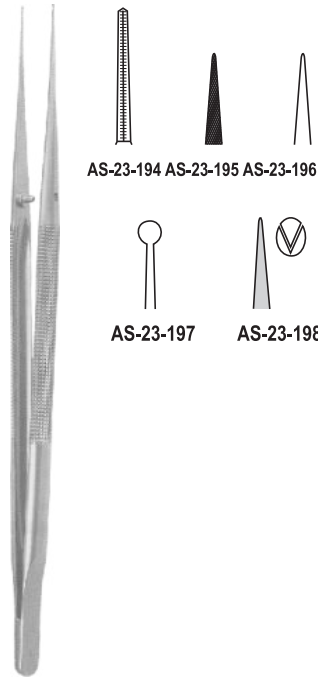

AS-23-194 AS-23-195 AS-23-196

AS-23-197 AS-23-198

AS-23-194 - AS-23-198
15, 18, 21 cm

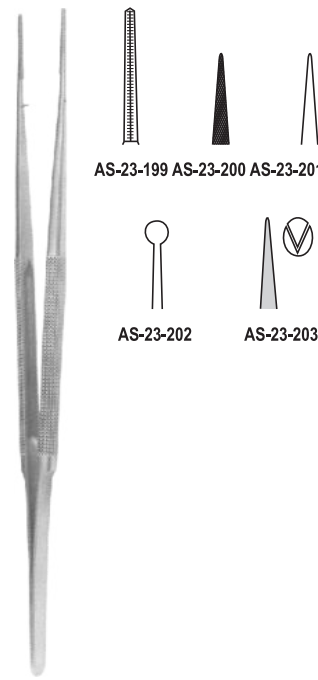

AS-23-199 AS-23-200 AS-23-201

AS-23-202 AS-23-203

AS-23-199 - AS-23-203
Forceps
15, 18, 21 cm

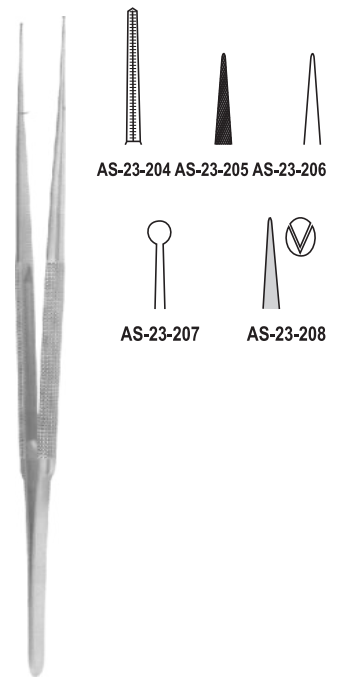

AS-23-204 AS-23-205 AS-23-206

AS-23-207 AS-23-208

AS-23-204 - AS-23-208
Forceps
15, 18, 21 cm

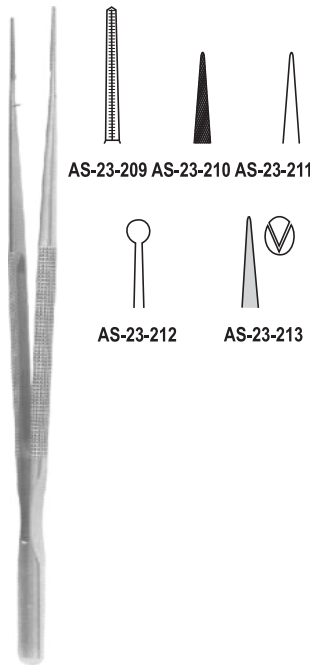

AS-23-209 AS-23-210 AS-23-211

AS-23-212 AS-23-213

AS-23-209 - AS-23-213
Forceps Counter
Balance
15, 18, 21 cm

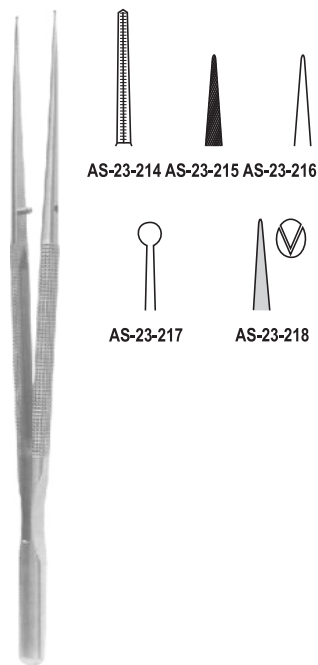

AS-23-214 AS-23-215 AS-23-216

AS-23-217 AS-23-218

AS-23-214 - AS-23-218
Forceps Counter
Balance
15, 18, 21,
23, 25 cm

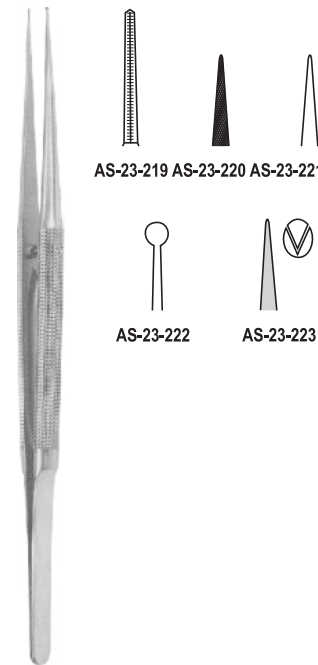

AS-23-219 AS-23-220 AS-23-221

AS-23-222 AS-23-223

AS-23-219 - AS-23-223
Forceps
15, 21, 23 cm

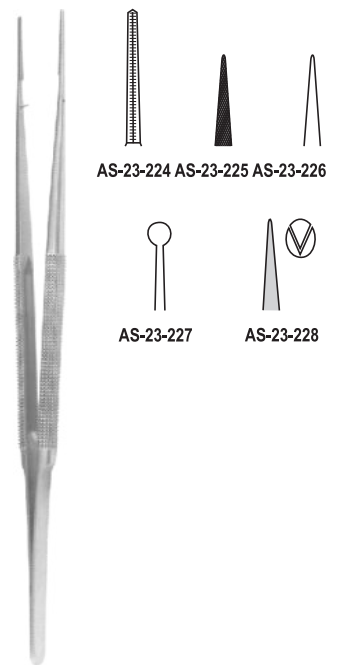

AS-23-224 AS-23-225 AS-23-226

AS-23-227 AS-23-228

AS-23-224 - AS-23-228
Forceps
18, 21 cm

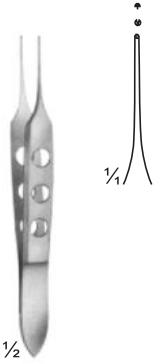

BISHOP-HARMON
AS-23-229
8.5 cm

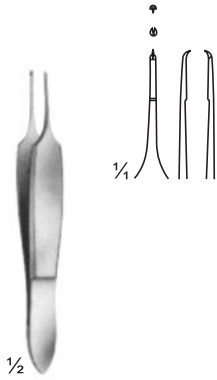

ST.MARTIN
AS-23-230
8 cm

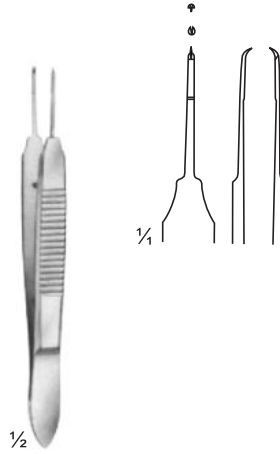

CASTROVIEJO
AS-23-231
teeth 0.9 mm
10 cm

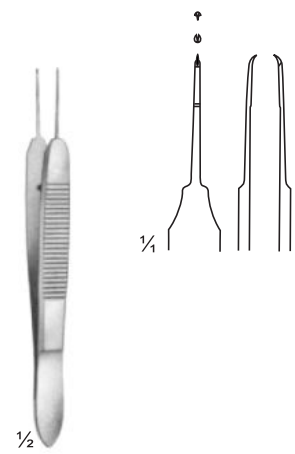

CASTROVIEJO
AS-23-232
teeth 0.5 mm
10 cm

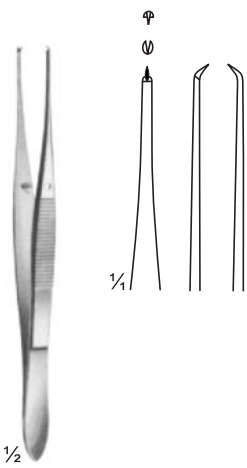

ELSCHING
AS-23-233
11 cm



GILL
AS-23-234
7.5 cm

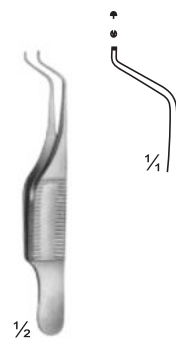

GILL - HESS
AS-23-235
7.5 cm

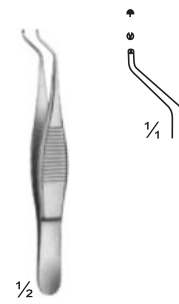

HESS AS-
23-236 7
cm

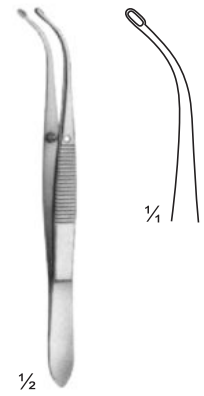

ARRUGA
AS-23-237
10 cm

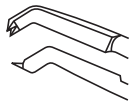

AS-23-238

AS-23-238
Colibri Forceps
With Tying Platform
8 cm



AS-23-239
Utility
Forceps 10
cm

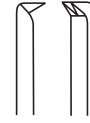

AS-23-240

AS-23-240 - 141
TUBINGEN
Suture Forceps
8.5, 11 cm

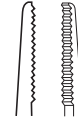

AS-23-241



AS-23-242
BONN
Suture Forceps
7.5 cm



AS-23-243
BONN
Iris Forceps
8 cm



AS-23-244
McDonalds-Spaleck
Lense Implantation
Forceps
Crossaction 10 cm
5, 6 mm



AS-23-245
FAULKNER
Holding
Forceps 10 cm
5, 6, 11 mm



AS-23-246
Spaleck-microma
Lense Implantation
Forceps
10 cm
5.6, 6.6 mm



AS-23-247
Hook



AS-23-248
JAMESON
Strabismus
Hook



AS-23-249
GRAEFE
Strabismus
Hook 13, 14 cm



AS-23-250
GRAEFE
Iris Hook



AS-23-251
GILLES
Skin Hook



AS-23-252
GUTHRIE
Fixation Hook,
double



AS-23-253
MEYHOFER
Spoon



AS-23-254
KUHN
Corneal
Scarifier



AS-23-255
GRAEFE
Scarifier



AS-23-256
Foreign Body
Needle



AS-23-257
HAMBURG
Air Keratome



AS-23-258
DESMARRS
Eye Retractor



AS-23-259
BOWMAN
Lachrymal
Probes



AS-23-260
WILDER
Lachrymal
Probes



AS-23-261
WEISS
Eye
Speculum



AS-23-262
CASTROVIEJO
Eye Speculum

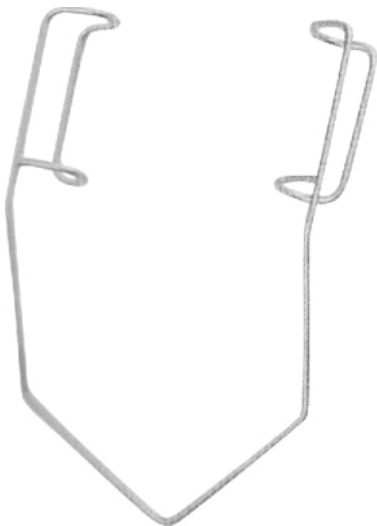

AS-23-263
BARRAQUER
Eye
Speculum

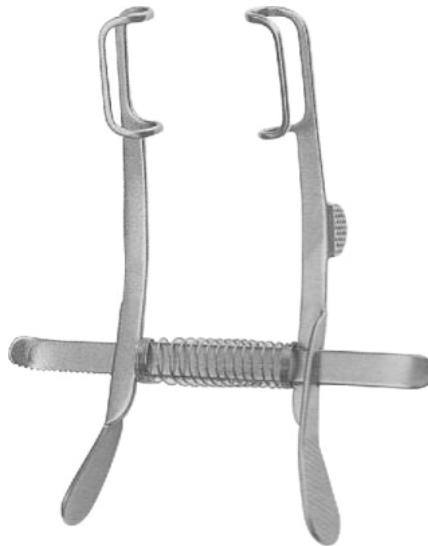

AS-23-264
MELLINGER
Eye
Speculum

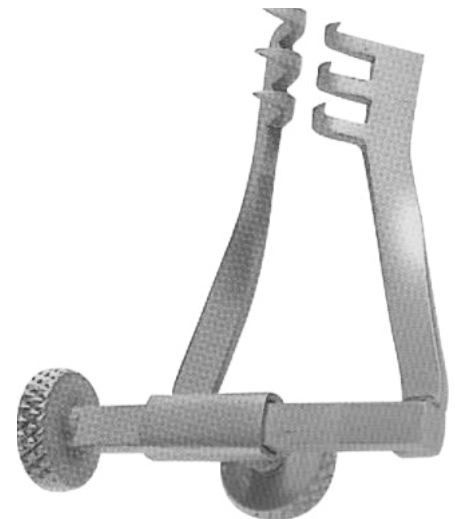

AS-23-265
MINIGOLDSTEIN Self-
Retaining Retractors 3
Teeth
2 cm

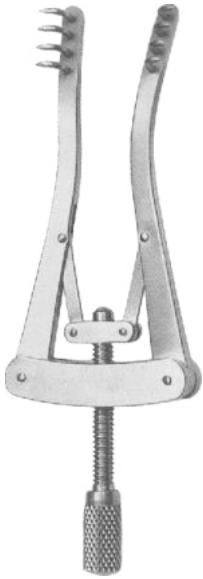

AS-23-266 ALM
Self-Retaining Retractors
4 Teeth
7 cm



AS-23-267 ALM
Self-Retaining Retractors
4 Teeth
10 cm



AS-23-268
HOLTZHEIMER Self-Retaining Retractors 4
Teeth
10 cm



AS-23-269
HOLTZHEIMER Self-Retaining Retractors 4
Teeth
10 cm

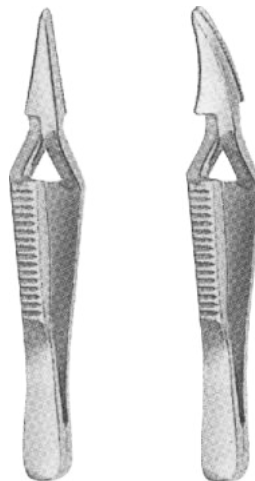

AS-23-270
Cross Action
Forceps
28 mm



AS-23-271
Cross Action
Forceps
35 mm

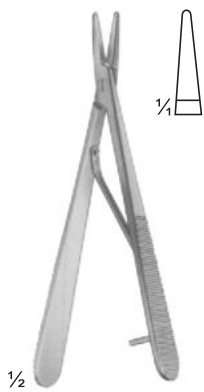

AS-23-272
ROHRSCHEIDER
With copper inserts
100 mm



AS-23-273
KALT
With catch
135 mm



AS-23-274
ARRUGA
With catch
135 mm





AS-23-275 - 176
CASTROVIEJO
With catch
145 mm



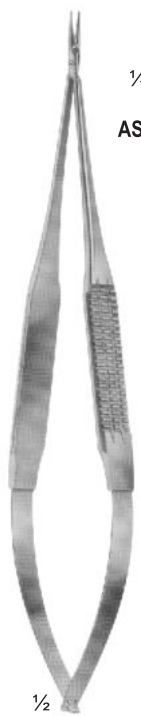

AS-23-277 - 178
CASTROVIEJO
Without Catch
160 mm





AS-23-279 **AS-23-280**

AS-23-279 - AS-23-280
Without catch
185 mm





AS-23-281 **AS-23-282**
With catch



AS-23-281 - AS-23-282
JACOBSON
185 mm



AS-23-283
Without catch

AS-23-283
Without catch
195 mm





AS-23-284 **AS-23-285**

AS-23-284 - AS-23-285
YASARGIL
With catch
200 mm

MICRO NEEDLE HOLDERS WITH ROUND HANDLES



AS-23-286
115 mm



AS-23-287
135 mm

AS-23-286 - AS-23-287
BARRAQUER
Without catch



AS-23-288



AS-23-289

AS-23-288 - AS-23-289
BARRAQUER
Without catch
120 mm



AS-23-290



AS-23-291

AS-23-290 - AS-23-291
BARRAQUER
Without catch
120 mm



AS-23-292



AS-23-293

AS-23-292 - AS-23-293
BARRAQUER
Without Catch
150 mm



AS-23-294 - AS-23-295
YASARGIL
200 mm



AS-23-296 - AS-23-297
YASARGIL
225 mm



AS-23-298
YASARGIL
245 mm

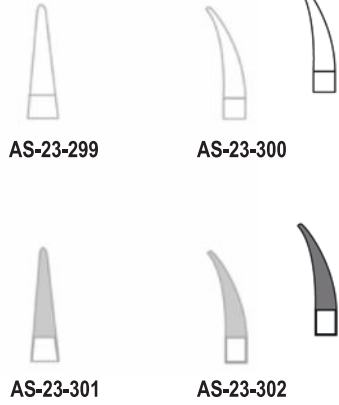

CASTROVIEJO
AS-23-299 - AS-23-302
145 mm

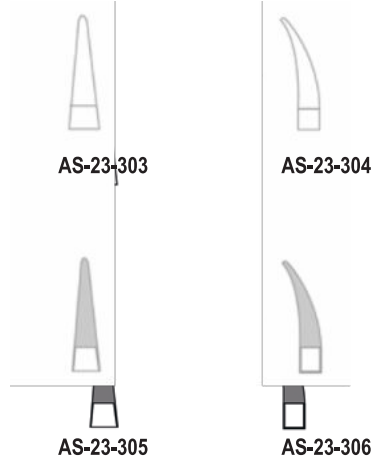

CASTROVIEJO
AS-23-303 - AS-23-306
180 mm

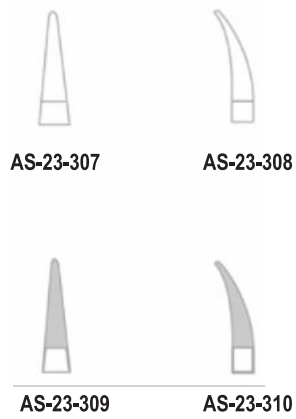

BARRAQUER
AS-23-307 - AS-23-310
145 mm



HEPP SCHEIDEL
AS-23-311
180 mm



ASAMAR
SURGICAL 

PAGE
552-564
SUCTION INSTRUMENTS

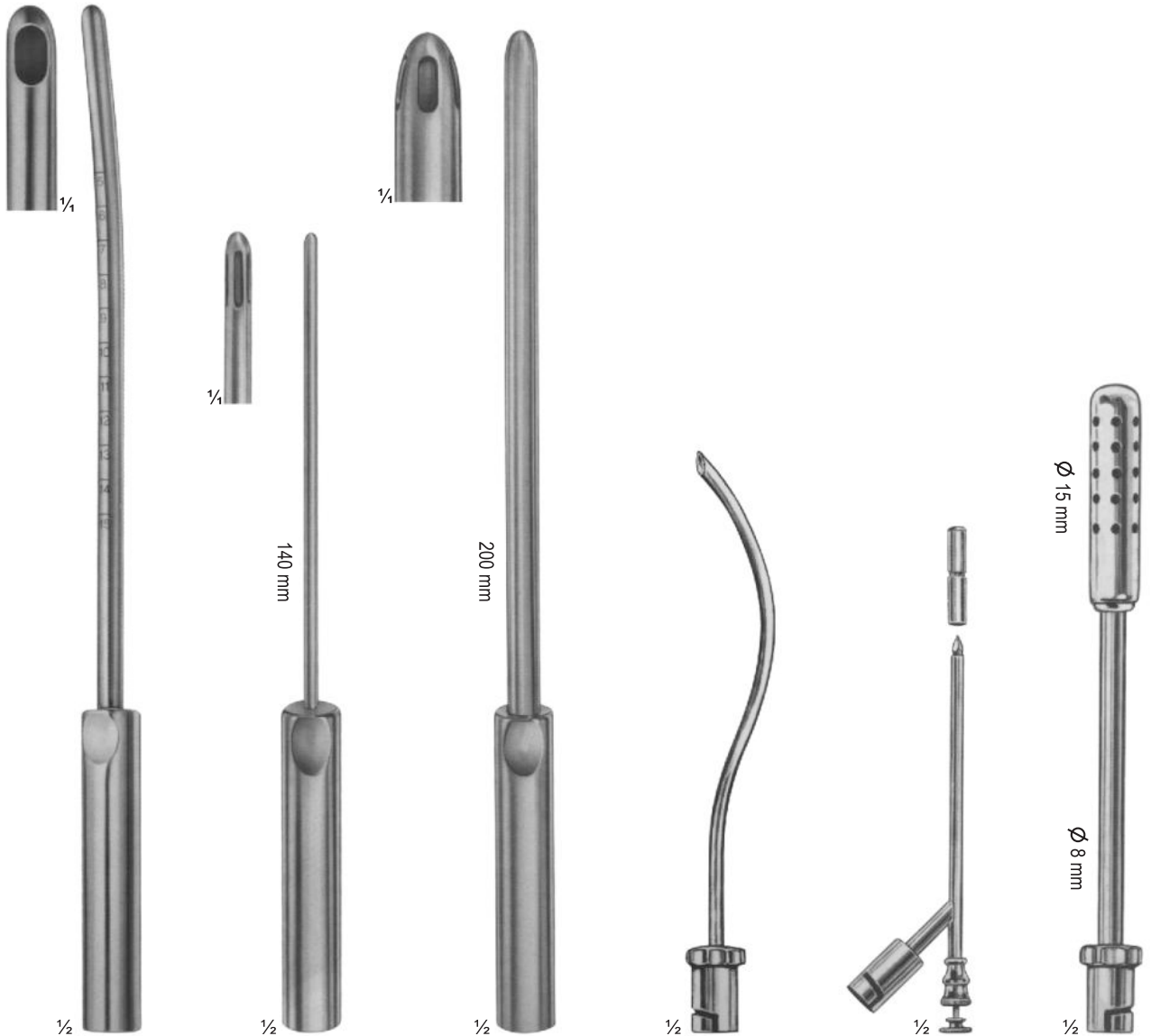

AS-24-101 - AS-24-106 BIEMER
AS-24-101 ø 4 mm
AS-24-102 ø 6 mm
AS-24-103 ø 8 mm
AS-24-104 ø 10 mm
AS-24-105 ø 12 mm
AS-24-106 ø 14 mm
 Curettes for aspiration lipectomy, graduated, slightly curved

AS-24-107 - AS-24-108 BIEMER
AS-24-107 ø 4 mm **AS-24-108** ø 6 mm
 Curettes for aspiration lipectomy, with three apertures, slightly curved malleable

AS-24-109 - AS-24-111 BIEMER
AS-24-109 ø 8 mm
AS-24-110 ø 10 mm
AS-24-111 ø 12 mm
 Curettes for aspiration lipectomy, with three apertures, slightly curved malleable

AS-24-112
 For aspirating fluid from the excretory ducts of large glands and for keeping the operating area clear 170 mm

AS-24-113
 Trocar
 For puncturing 150 mm

AS-24-114
 For clearing large quantities of fluid 190 mm



AS-24-115
Trocar
For
puncturing
170 mm

AS-24-116
Hollow needle,
sharp
150 mm

AS-24-117
double
curved For
general
surgery
230 mm

AS-24-118
For tonsillectomy,
oral and laryngeal
operations
190 mm

AS-24-119
For tonsillectomy,
oral and laryngeal
operations
220 mm

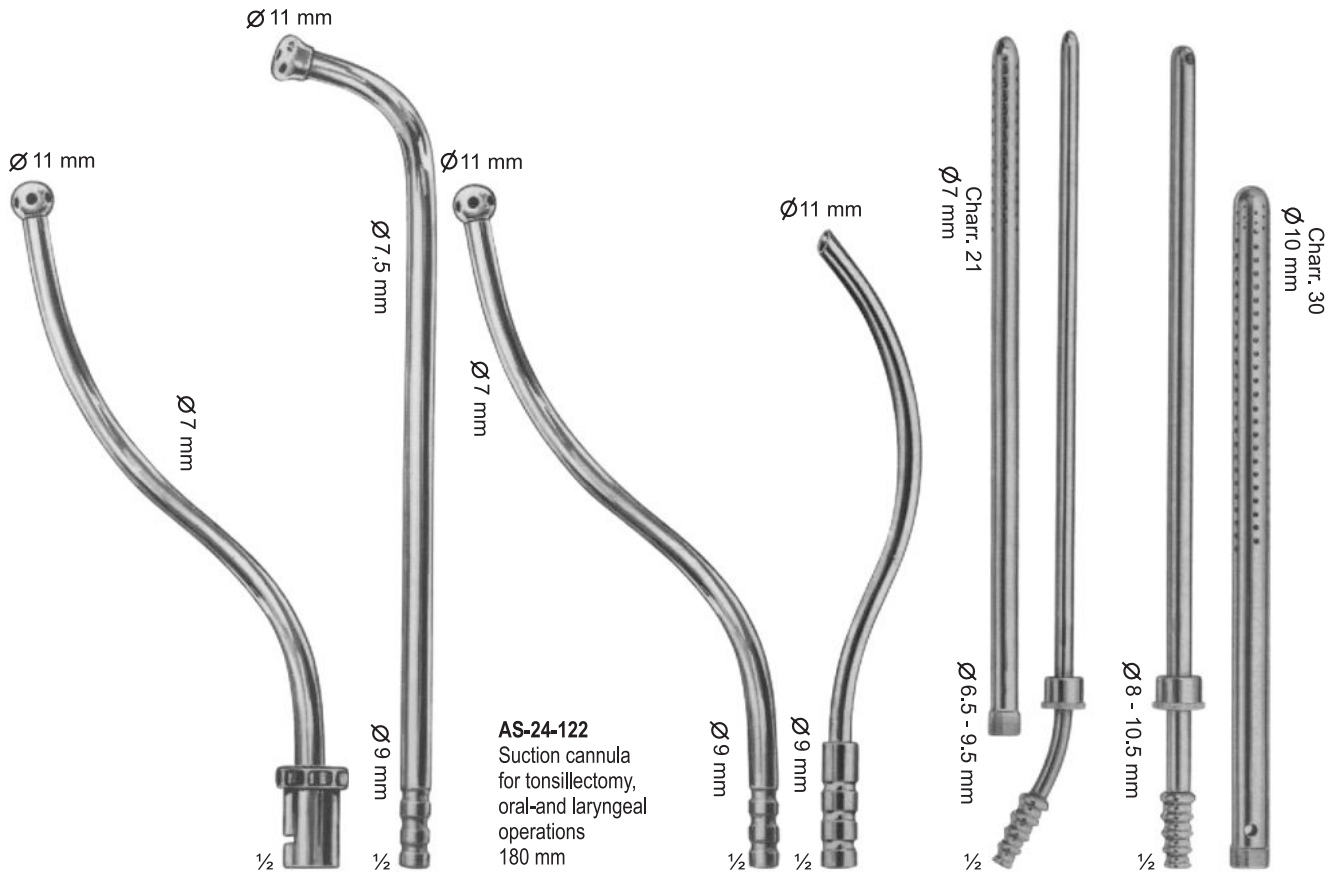

AS-24-120
For tonsillectomy,
oral-and laryngeal
operations
180 mm

AS-24-121
Suction cannula
for tonsillectomy,
oral-and laryngeal
operations
220 mm

AS-24-122
Suction cannula
for tonsillectomy,
oral-and laryngeal
operations
180 mm

AS-24-123
S-shaped blunt cannula
for aspirating fluid from
the excretory ducts of
large glands and for
keeping the operations
area clear
170 mm

AS-24-124
POOL
Suction cannula,
with outer tube
to be screwed of
225 mm

AS-24-125
POOL
Suction cannula,
with outer tube
to be screwed
of 225 mm

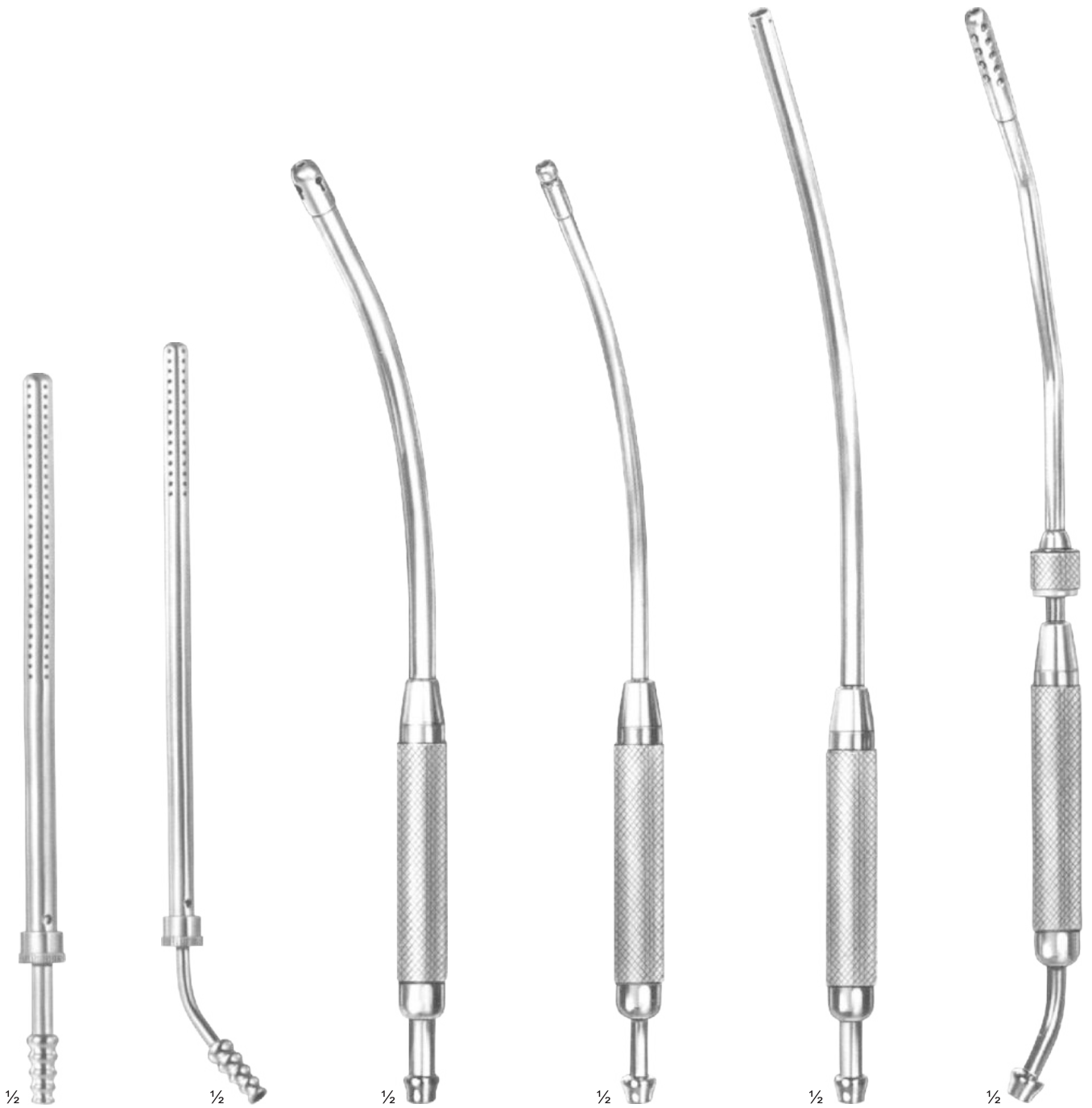

POOLE
AS-24-126
24 cm
Ø10 mm

POOLE
AS-24-127
25 cm
Ø 8 mm

COLLEY **AS-24-128**
with perforated screw tip
31 cm
Ø10 mm

COLLEY **AS-24-129**
with perforated screw tip
31 cm
Ø7 mm

COLLEY
AS-24-130
36 cm
Ø 8 mm

COLLEY **AS-24-131**
with perforated screw tip
36 cm
Ø 8 mm

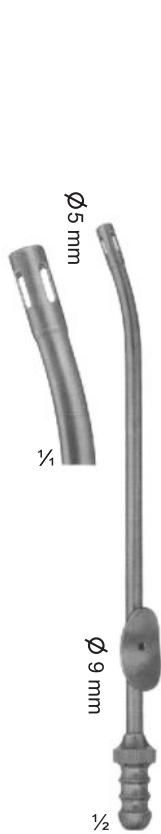

DE-BAKEY AS-24-132 with finger cut-off and stylet 16 cm



NUBOER AS-24-133 round opening 21 cm \varnothing 10 mm



NUBOER AS-24-134 oval opening 21 cm \varnothing 6 mm



FRAZIER AS-24-135 24 cm \varnothing 3.3 mm



ADSON AS-24-136 20 cm \varnothing 4 mm



COUPLAND AS-24-137 - AS-24-140 with tube connector 17 cm

AS-24-137 9 cm \varnothing 1.5 mm

AS-24-138 9 cm \varnothing 2 mm

AS-24-139 9 cm \varnothing 2.5 mm

AS-24-140 9 cm \varnothing 3.5 mm



AS-24-141 9 cm \varnothing 3 mm

AS-24-142 9 cm \varnothing 3.5 mm

AS-24-143 9 cm \varnothing 4.3 mm



COGSWELL AS-24-144 with finger cut-off 24.5 cm \varnothing 3.8 mm



YANKAUER
AS-24-145
complete, with suction
tip and connector
31 cm



YANKAUER **AS-24-146**
complete, with handle , 4 tube,
suction tip and tube connector
31 cm



AS-24-147
Handle
15 cm



AS-24-148
2.5 cm



Fig. 0
AS-24-149
10 cm



Fig. 1
AS-24-150
10 cm



Fig. 2
AS-24-151
10 cm



Fig. 3
AS-24-152
complete, with
suction tip
13.5 cm



WULLSTEIN
AS-24-153
 Suction tube, conical, silver, olive
 with LUER hub
 16 cm

Ø1,75 mm

Ø3 mm
 1/2
 Ø8 mm

WULLSTEIN
AS-24-154 1.5 mm
AS-24-155 2 mm
 Suction tube, cylindrical, silver, with
 stylet with LUER hub
 16 cm

1/2
 Ø8 mm

Usable length

YASARGIL usable length diam.
AS-24-156 13 cm 1.5 mm
AS-24-157 15 cm 1.5 mm
AS-24-158 18 cm 1.5 mm
AS-24-159 22 cm 1.5 mm
AS-24-160 13 cm 2 mm
AS-24-161 15 cm 2 mm
AS-24-162 18 cm 2 mm
AS-24-163 22 cm 2 mm

YASARGIL usable length diam.
AS-24-164 13 cm 2.5 mm
AS-24-165 15 cm 2.5 mm
AS-24-166 18 cm 2.5 mm
AS-24-167 22 cm 2.5 mm
AS-24-168 13 cm 3.5 mm
AS-24-169 15 cm 3.5 mm
AS-24-170 18 cm 3.5 mm
AS-24-171 22 cm 3.5 mm

Ø6.5-9 mm
 with LUER hub

LANDOLT
AS-24-172 - AS-24-174
 15 cm
 diam Ø 3 mm

AS-24-172 8 mm / curved
AS-24-173 11mm / curved
AS-24-174 15mm / curved

Ø3.5 mm

Ø2.0 mm

AS-24-175 5 cm
AS-24-176 35 cm
 with rubber tip,
 with LUER hub

Ø9 mm

AS-24-177 2 mm diam
AS-24-178 2.5 mm diam
AS-24-179 3 mm diam
 with finger cut-off,
 thumb piece 90° to
 curved, with LUER hub
 25 cm

Ø6.9 mm

COMBINED SUCTION & IRRIGATION CANNULA



ASAMAR
SURGICAL

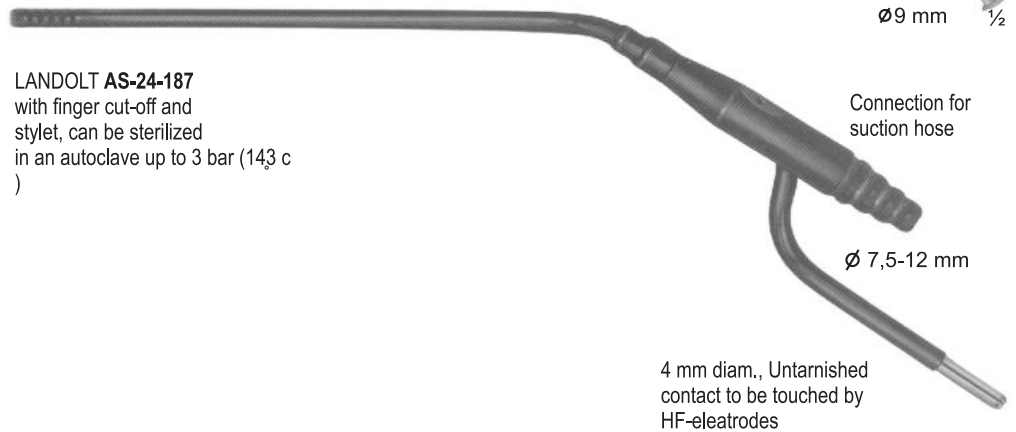
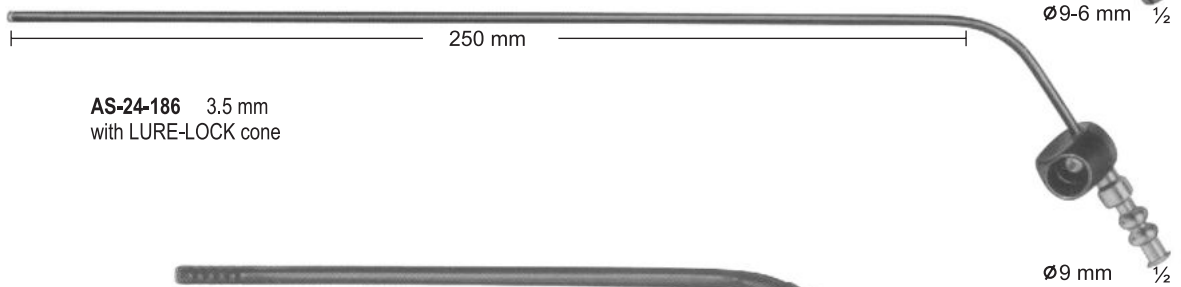
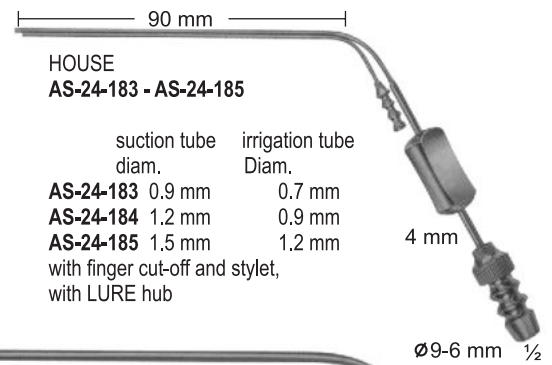
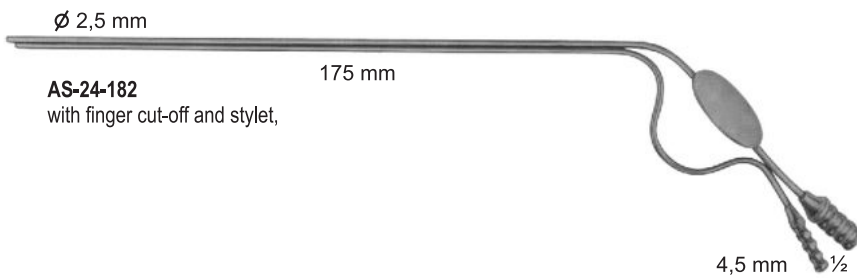
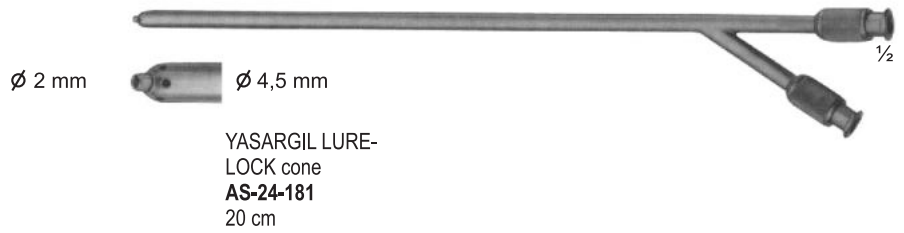
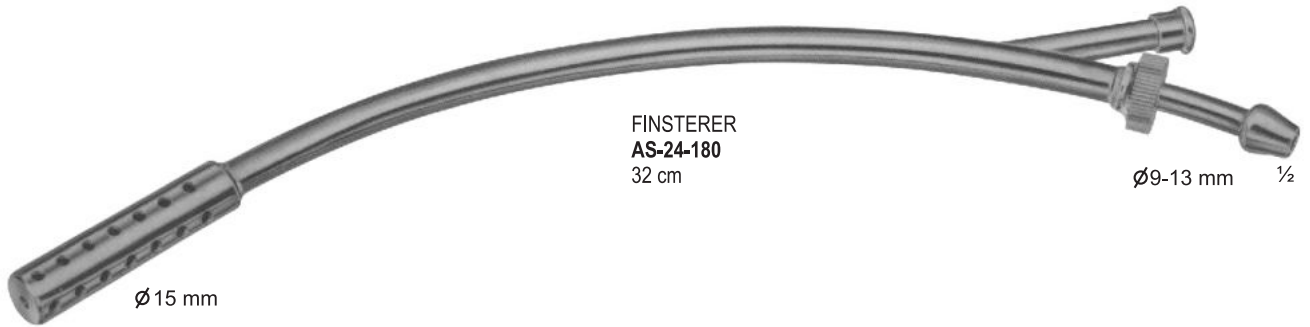



1/2

WULLSTEIN
AS-24-188 - AS-24-190
14 cm
handle with tube, only



WULLSTEIN
AS-24-188
4.5 cm
Mirco Suction Cannula
Complete, with handle and 3
Øs 0.4 mm



WULLSTEIN
AS-24-189
4.5 cm
Mirco Suction Cannula
Complete, with handle and 3
Øs 0.6 mm



WULLSTEIN
AS-24-190
4.5 cm
Mirco Suction Cannula
Complete, with handle and 3
Øs 0.8 mm



AS-24-191
working length 75
mm Ø1 mm



AS-24-192
working length 75
mm Ø1.5 mm



AS-24-193
working length 75
mm Ø2 mm



1/2

BARON-SCHUKNECHT
AS-24-191 - AS-24-193
with finer cut-off



1/2

ZOELLNER
AS-24-194 - AS-24-197
Suction Cannula

Suction Tip

- AS-24-194 Ø 0.5 mm
- AS-24-195 Ø 0.7 mm
- AS-24-196 Ø 0.9 mm
- AS-24-197 Ø 1.2 mm

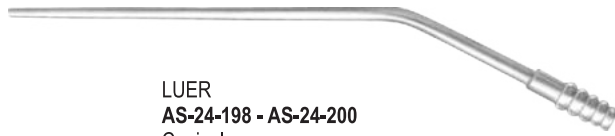

LUER
AS-24-198 - AS-24-200
Conical

1/2

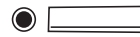

AS-24-198
16.5 cm
Ø 3 mm
working length
110 mm

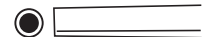

AS-24-199
16.5 cm
Ø 3.5 mm
working
length 110
mm



AS-24-200
18 cm
Ø 4.5 mm
working
length 130
mm

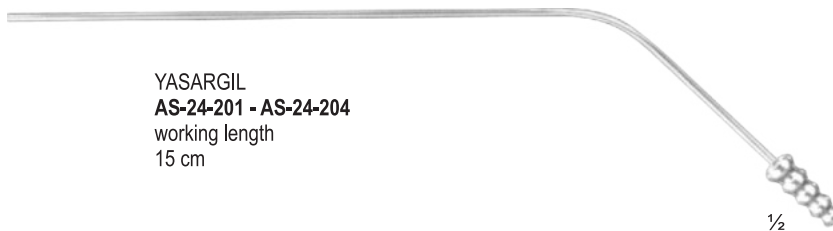

YASARGIL
AS-24-201 - AS-24-204
working length
15 cm

1/2



AS-24-201
17 cm
Ø 1.5 mm



AS-24-202
17 cm
Ø 2 mm



AS-24-203
17 cm
Ø 2.5 mm

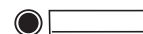

AS-24-204
17 cm
Ø 3.5 mm



AS-24-205
YANKAUER
with especially large
central bore, 4,8
mm diam.
285 mm

AS-24-206
YANKAUER
with central bore,
2,0 mm diam.
285 mm

AS-24-207
DE-BAKEY
with central bore,
3,0 mm diam. with
lateral slots
275 mm

AS-24-208
DE-BAKEY
with finger cut-off
and stylet
270 mm

AS-24-209
DE-BAKEY
with finger cut-off
and stylet
160 mm

AS-24-210
with finger
cut-off
190 mm

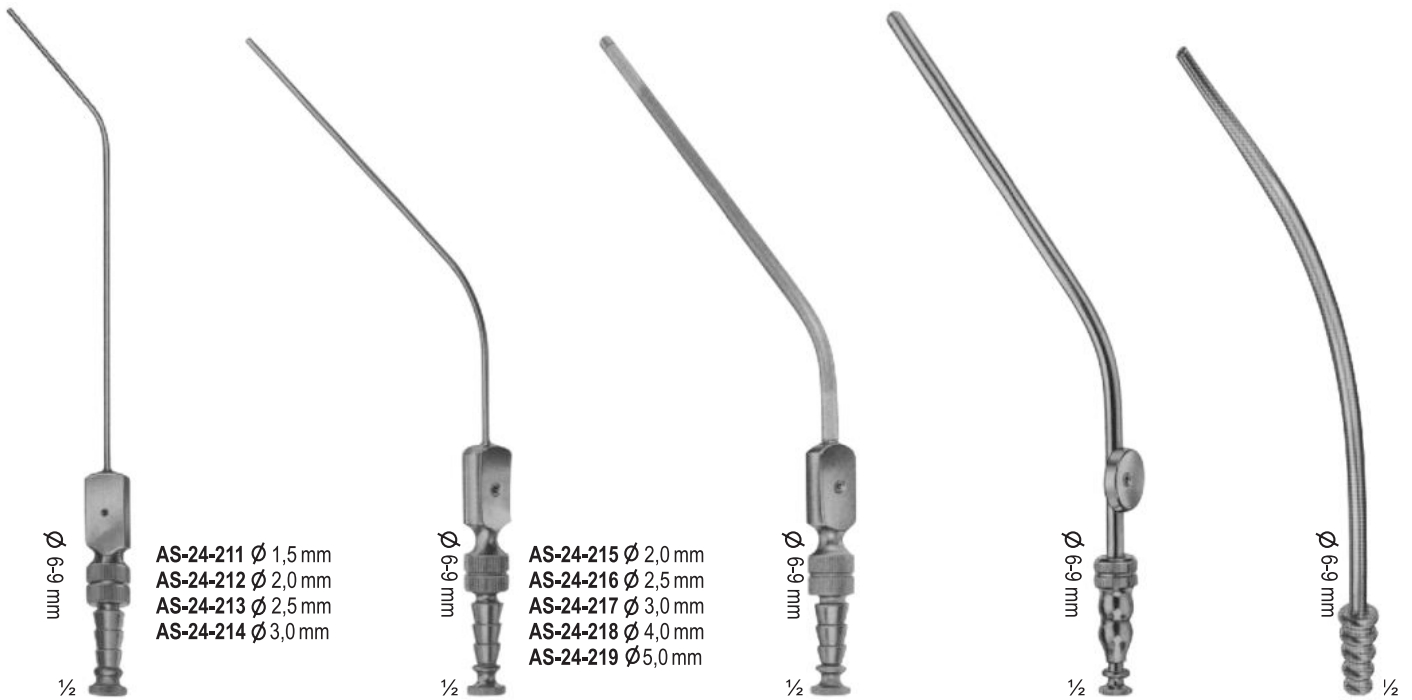

AS-24-211 - AS-24-214
 PLESTER
 with finger cut-off and
 stylet, thumb piece
 parallel to curved, with
 LUER hub
 195 mm

AS-24-215 - AS-24-219
 FERGUSSON
 with finger cut-off and
 stylet, thumb piece
 90° to curved, with LUER
 hub
 180 mm

AS-24-220 \varnothing 4,0 mm
 FERGUSSON
 insulated, with finger cut-off
 and stylet, thumb piece 90°
 to curved, with LUER hub
 180 mm

AS-24-221 \varnothing 3,0 mm
AS-24-222 \varnothing 5,0 mm
 FRAZIER
 insulated, with finger
 cut-off and stylet, thumb
 piece 90° to curved,
 with LUER hub
 180 mm

AS-24-223
 5,0 mm diam., Tip
 6,5 mm
 wide, Nasal suction
 tube, with LUER
 hub
 180 mm



AS-24-224 \varnothing 4,5 mm
AS-24-225 \varnothing 5,5 mm
Nasal suction tubes
175 mm



AS-24-226
GORNEY
Suction
dissector 180
mm



AS-24-227 4 mm wide
AS-24-228 5 mm wide
Suction raspatories,
sharp, bayonet-
shaped, with styelt
200 mm



AS-24-229 LOPEZ-
REINKE Tonsil
dissector with
suction device
235 mm



AS-24-230
SPACKMAN CANNULA
Surgical and Latexfree
Cone the depth of the uterus
and to allow
for gentle dilation of the
cervix Length: 360 mm

☎ 0092 52 3572454
☎ 0092 52 3572455
☎ +92 300 3572450

🌐 www.retractorspecialist.com
✉ sales@retractorspecialist.com
📍 Roras Road, Sialkot 51310, Pakistan



ISO
9001:2015
Certified

